

Using the TPS53310EVM-755, A 3-A Eco-mode™ Integrated Switcher With Master-Slave

The TPS53310EVM-755 evaluation module (EVM) is a high-efficiency evaluation platform with two TPS53310 3-A, integrated FET, step-down converters working in a Master-Slave synchronization scheme. The two outputs are 1.5 V/3 A (master) and 1.2 V/3 A (slave) from a 3.3-V or 5-V input bus. The EVM uses the TPS53310 synchronous buck controller with integrated switcher.

Contents

1	Description	3
	1.1 Typical Applications	3
	1.2 Features	3
2	Electrical Performance Specifications	3
3	Schematic	5
4	Test Setup	6
	4.1 Test Equipment	6
	4.2 Recommended Test Setup	7
5	Configuration	8
	5.1 5Vin Option (J1: 5Vin Option)	8
	5.2 Mode Selection (J2: MST Mode)	8
	5.3 Mode Selection (J7: SLV Mode)	8
	5.4 Synchronization (J5: SYNC)	8
	5.5 Master Enable (J4: EN_MST)	9
	5.6 Slave Enable (J9: EN_SLV)	9
6	Test Procedure	9
	6.1 Line/Load Regulation and Efficiency Measurement Procedure	9
	6.2 Loop Gain/Phase Measurement	9
	6.3 List of Test Points	10
	6.4 Equipment Shutdown	10
7	Performance Data and Typical Characteristic Curves	10
	7.1 Efficiency	11
	7.2 Load Regulation	11
	7.3 Line Regulation	12
	7.4 1.5-V Output Ripple	12
	7.5 1.5-V Switching Node at Full Load	13
	7.6 1.5-V Switching Node at No Load	13
	7.7 Master-Slave 180° Synchronization	14
	7.8 1.5-V Master Turnoff During Master-Slave Synchronization	14
	7.9 1.5-V Output Transient	15
	7.10 1.5-V Turnon Waveform	15
	7.11 1.5-V Turnoff Waveform	16
	7.12 1.5-V Hiccup OCP Waveform	16
	7.13 1.5-V Bode Plot	17
	7.14 EVM Top Board Thermal Image	17
8	EVM Assembly Drawings and PCB Layout	18
9	Bill of Materials	22

Eco-mode is a trademark of Texas Instruments.

List of Figures

1	TPS53310EVM-755 Schematic	5
2	Tip and Barrel Measurement for Vout Ripple	6
3	TPS53310EVM-755 Recommended Test Setup	7
4	TPS53310EVM-755 Efficiency.....	11
5	TPS53310EVM-755 Load Regulation	11
6	TPS53310EVM-755 Line Regulation	12
7	TPS53310EVM-755 Output Ripple (3.3 Vin, 1.5 V/3 A).....	12
8	TPS53310EVM-755 Switching Node at Full Load (5 Vin, 1.5 V/3 A).....	13
9	TPS53310EVM-755 Switching Node at No Load (5 Vin, 1.5 V/0 A DE Mode).....	13
10	TPS53310EVM-755 Synchronization (3.3 Vin, 1.5 V/3 A, 1.2 V/3 A 180° Synchronization)	14
11	TPS53310EVM-755 Synchronization (3.3 Vin, 1.5 V/3 A, 1.2 V/3 A 180° Synchronization, Then Turn Off Master)	14
12	TPS53310EVM-755 1.5-V Output Transient (5 Vin, 1.5 V/0 A-3 A)	15
13	TPS53310EVM-755 Enable Turns On Waveform (3.3 Vin, 1.5 V/3 A).....	15
14	TPS53310EVM-755 Enable Turns Off Waveform (3.3 Vin, 1.5 V/3 A).....	16
15	TPS53310EVM-755 Hiccup OCP Waveform (5 Vin, 1.5 V/5.5 A OCP).....	16
16	TPS53310EVM-755 Bode Plot (3.3 Vin, 1.5 V/3 A).....	17
17	TPS53310EVM-755 Top-Side Thermal Image (3.3 Vin, 1.5 V/3 A, 1.2 V/3 A).....	17
18	TPS53310EVM-755 Top Layer Assembly Drawing, Top View	18
19	TPS53310EVM-755 Bottom Assembly Drawing, Bottom View.....	19
20	TPS53310EVM-755 Top Copper, Top View	19
21	TPS53310EVM-755 Internal Layer 2, Top View	20
22	TPS53310EVM-755 Internal Layer 3, Top View	20
23	TPS53310EVM-755 Bottom Copper, Top View	21

List of Tables

1	TPS53310EVM-755 Electrical Performance Specifications	3
2	5Vin Option	8
3	Master Mode Selection	8
4	Slave Mode Selection	8
5	Synchronization Selection	8
6	Master Enable Selection	9
7	Slave Enable Selection.....	9
8	Functions of Each Test Points	10
9	Bill of Materials.....	22

1 Description

The TPS53310EVM-755 uses a regulated 3.3-V or 5-V bus to produce outputs at up to 3 A of load current. The output is 1.5-V master and 1.2-V slave. The TPS53310EVM-755 is designed to demonstrate the TPS53310 in a typical low-voltage application while providing test points to evaluate the performance of the TPS53310.

1.1 Typical Applications

- Servers, notebook/netbook computers
- Multifunction printers (MFP)
- Embedded personal computers, POS terminals
- Switches, routers
- Low-voltage, point-of-load converters
- Any Energy Star/80Plus low-voltage rail

1.2 Features

The TPS53310EVM-755 features:

- 1.5-V master and 1.2-V slave outputs
- 3-Adc steady-state current
- 1.1-MHz switching frequency
- Hiccup overcurrent protection
- J1: selectable 3.3-V or 5-V input voltage
- J2, J7: selectable FCCM, DE, HEF mode
- J5: selectable master and slave interleaved operation
- J4, J9 for master and slave enable function
- Loop gain measurement
- Convenient test points for probing critical waveforms
- Four-layer PCB with 2 oz of copper on the outside layers

2 Electrical Performance Specifications

Table 1. TPS53310EVM-755 Electrical Performance Specifications

PARAMETER	TEST CONDITIONS	MIN	TYP	MAX	UNITS
INPUT CHARACTERISTICS					
VIN input voltage range*	Vin	2.9	3.3/5	6	V
Maximum input current	Vin = 3.3 V, 1.5 V/ 3 A, 1.2 V/3 A, FCCM			2.82	A
No-load input current	Vin = 3.3 V, 1.5 V/0 A, 1.2 V/0 A, FCCM			40	mA
OUTPUT CHARACTERISTICS					
Master output voltage Vo_MST		1.485	1.5	1.515	V
Slave output voltage Vo_SLV		1.188	1.2	1.212	V
Output voltage regulation	Line regulation		0.1		%
	Load regulation		1.0		%
Output voltage ripple	Vin = 3.3 V, 1.5 V/0 A-3 A, 1.2 V/0 A-3 A			20	mVpp
Output load current		0		3	A
Output over current			4.5		A
SYSTEMS CHARACTERISTICS					
Switching frequency	Fixed		1.1		MHz
1.5-V, full-load efficiency	Vin = 3.3 V, 1.5 V/3 A		88.82		%
1.5-V, full-load efficiency	Vin = 5 V, 1.5 V/3 A		89.50		%

Table 1. TPS53310EVM-755 Electrical Performance Specifications (continued)

PARAMETER	TEST CONDITIONS	MIN	TYP	MAX	UNITS
1.2-V, full-load efficiency	V _{in} = 3.3 V, 1.2 V/3 A		86.50		%
1.2-V, full-load efficiency	V _{in} = 5 V, 1.2 V/3 A		87.32		%
Operating temperature			25		°C

Note: Jumpers set to default locations; see [Section 5](#) of this user's guide.

3 Schematic

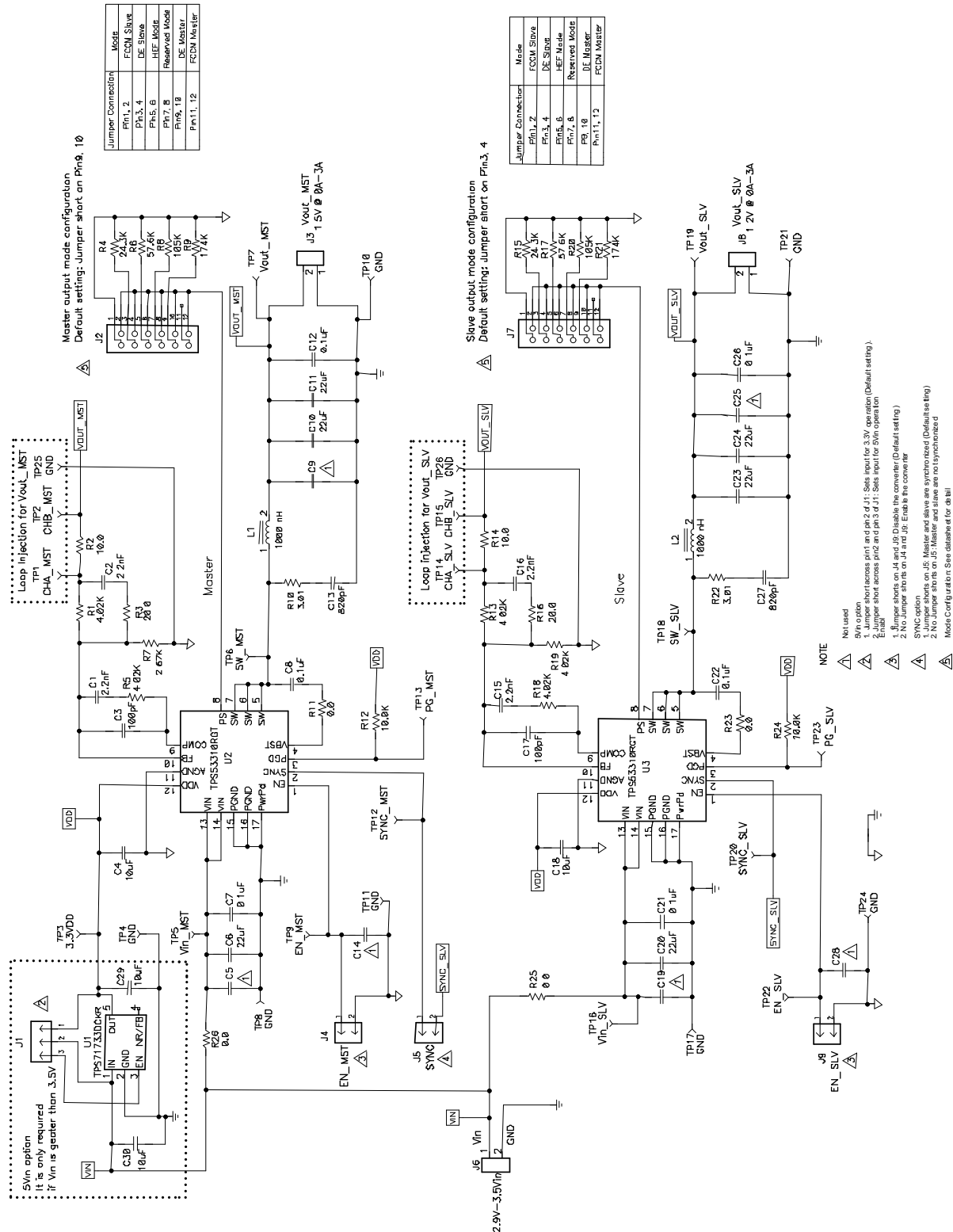

Figure 1. TPS53310EVM-755 Schematic

4 Test Setup

4.1 Test Equipment

Voltage Source VIN:

The input voltage source VIN must be a 0-V to 6-V variable dc source capable of supplying 3 Adc. Connect Vin to J6 as shown in [Figure 3](#).

Multimeters: V1:

Vin at TP5 (Vin_MST) and TP8 (GND)

V2: 1.5 Vout at TP7 (Vout_MST) and TP10 (GND)

V3: 1.2 Vout at TP19 (Vout_SLV) and TP21 (GND)

A1: Vin input current

Output Load:

Load1: The output load1 must be an electronic constant-resistance-mode load capable of 0 Adc to 5 Adc at 1.5 V.

Load2: The output load2 must be an electronic constant-resistance-mode load capable of 0 Adc to 5 Adc at 1.2 V.

Oscilloscope:

A digital or analog oscilloscope can be used to measure the output ripple. The oscilloscope must be set for 1-M Ω impedance, 20-MHz bandwidth, ac coupling, 1- μ s/division horizontal resolution, 20-mV/division vertical resolution. Test points TP7, TP10 can be used to measure 1.5-V master output ripple voltage. TP19 and TP21 can be used to measure 1.2-V slave output ripple voltage. Place the oscilloscope probe tip through TP7 (TP19), and hold the ground barrel TP10 (TP21) as shown in [Figure 2](#).

Do not use a leaded ground connection as this may induce additional noise due to the large ground loop.

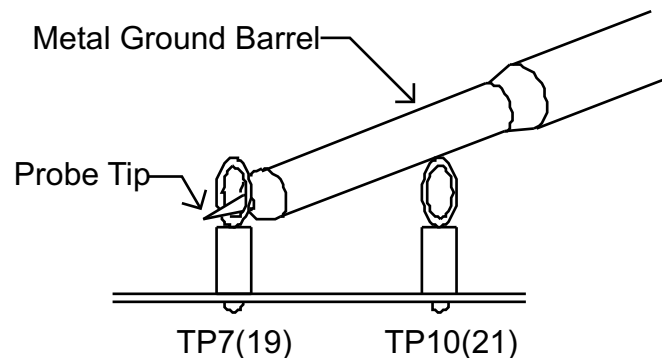

Figure 2. Tip and Barrel Measurement for Vout Ripple

Recommended Wire Gauge:

1. Vin to J6: The recommended wire size is AWG 16 per input connection, with the total length of wire less than 4 feet (2-foot input, 2-foot return).
2. J3 to LOAD1 the minimum recommended wire size is AWG 16, with the total length of wire less than 4 feet (2-foot input, 2-foot return)
3. J8 to LOAD2 the minimum recommended wire size is AWG16, with the total length of wire less than 4 feet (2-foot input, 2-foot return)

4.2 Recommended Test Setup

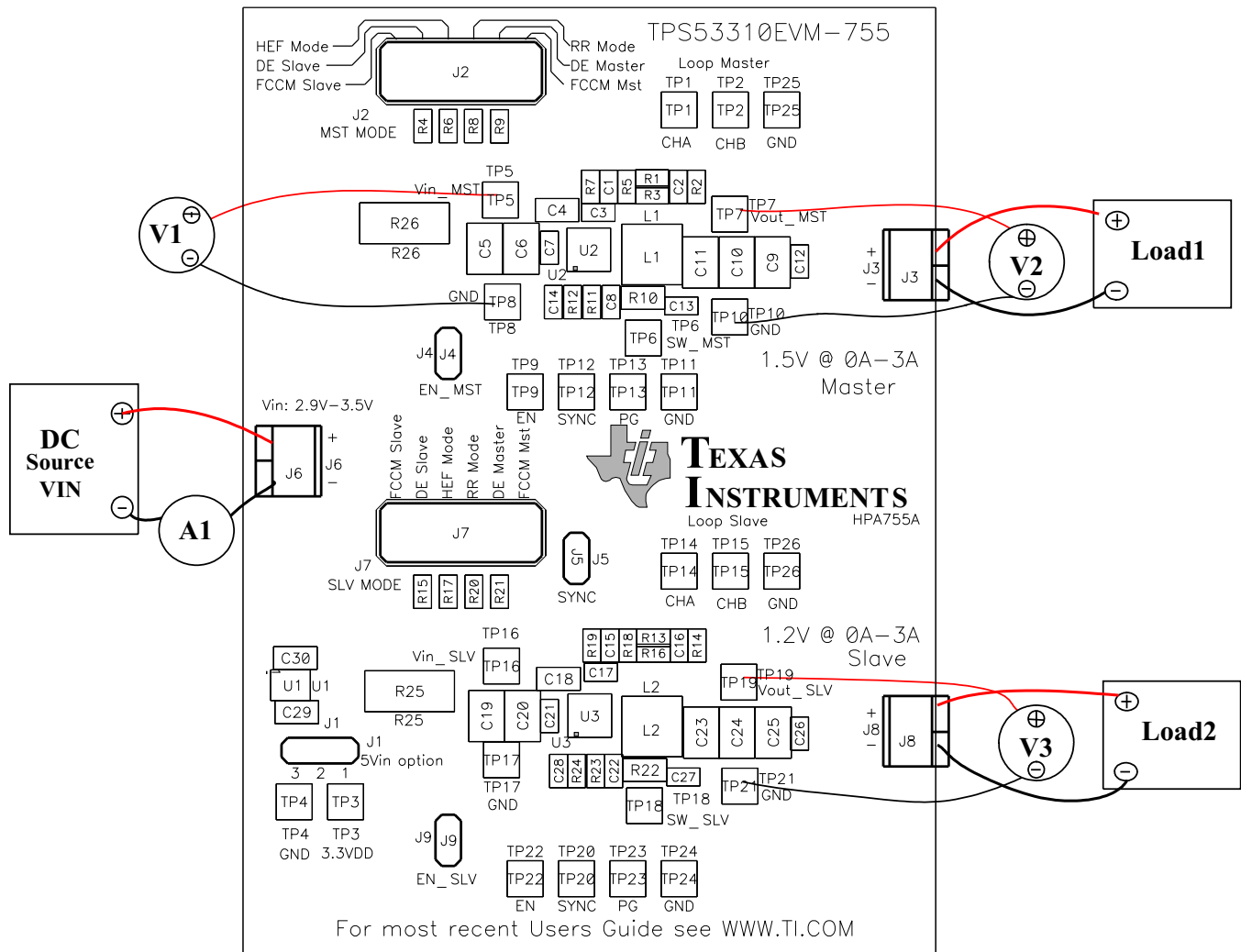

Figure 3. TPS53310EVM-755 Recommended Test Setup

Figure 3 is the recommended test setup to evaluate the TPS53310EVM-755. When working at an ESD workstation, make sure that any wrist straps, bootstraps, or mats are connected referencing the user to earth ground before handling the EVM.

Input Connections:

1. Prior to connecting the dc input source VIN, it is advisable to limit the source current from VIN to 5 A maximum. Ensure that VIN is set initially to 0 V and connected as shown in Figure 3.
2. Connect a voltmeter V1 at TP5 (Vin_MST) and TP8 (GND) to measure input voltage.
3. Connect a current meter A1 between VIN DC source and J6.

Output Connections:

1. Connect Load1 to J3, and set Load to constant resistance mode to sink 0 Adc before Vin is applied.
2. Connect a voltmeter V2 at TP7 (Vout_MST) and TP10 (GND) to measure the 1.5-V output voltage.
3. Connect Load2 to J8, and set Load to constant resistance mode to sink 0 Adc before Vin is applied.
4. Connect a voltmeter V3 at TP19 (Vout_SLV) and TP21 (GND) to measure the 1.2-V output voltage.

5 Configuration

All jumper selections must be made prior to applying power to the EVM. Users can configure this EVM per following configurations.

5.1 5Vin Option (J1: 5Vin Option)

The 5-V input option can be set by
J1 Default setting: 3.3Vin.

Table 2. 5Vin Option

Jumper Set to	Input Voltage
1-2 pin shorted	3.3Vin
2-3 pin shorted	5Vin

5.2 Mode Selection (J2: MST Mode)

The Master mode selection can be set by J2.
Default setting: FCCM_Mst

Table 3. Master Mode Selection

Jumper set to	Mode
Left (1-2 pin shorted)	FCCM Slave
Second (3-4 pin shorted)	DE Slave
Third (5-6 pin shorted)	HEF
Fourth (7-8 pin shorted)	Reserved
Fifth (9-10 pin shorted)	DE Master
Right(11-12 pin shorted)	FCCM Master

5.3 Mode Selection (J7: SLV Mode)

The Slave mode selection can be set by J7.
Default setting: FCCM_Slave

Table 4. Slave Mode Selection

Jumper set to	Mode
Left (1-2 pin shorted)	FCCM Slave
Second (3-4 pin shorted)	DE Slave
Third (5-6 pin shorted)	HEF
Fourth (7-8 pin shorted)	Reserved
Fifth (9-10 pin shorted)	DE Master
Right(11-12 pin shorted)	FCCM Master

5.4 Synchronization (J5: SYNC)

The synchronization for input interleaving can be set by J5.

Default setting: Jumper on J5, Master and Slave 180° Interleaved

Table 5. Synchronization Selection

Jumper set to	Master and Slave Synchronization
Jumper shorts on J5	Yes
No Jumper on J5	No

5.5 Master Enable (J4: EN_MST)

The Master Enable can be set by J4.
Default setting: Jumper on J4

Table 6. Master Enable Selection

Jumper set to	Enable/Disable Controller
Jumper shorts on J4	Disable 1.5-V Master output
No Jumper on J4	Enable 1.5-V Master output

5.6 Slave Enable (J9: EN_SLV)

The Slave Enable can be set by J9.
Default setting: Jumper on J9

Table 7. Slave Enable Selection

Jumper set to	Enable/Disable Controller
Jumper shorts on J9	Disable 1.2-V Master output
No Jumper on J9	Enable 1.2-V Master output

6 Test Procedure

6.1 Line/Load Regulation and Efficiency Measurement Procedure

1. Ensure that Load1 and Load2 are set to constant resistance mode and sink 0 A.
2. Ensure that all jumper configuration settings are per [Section 5](#).
3. Ensure that jumpers short on J4, J9 before Vin is applied.
4. Increase Vin from 0 V to 3.3 V. Use V1 to measure input voltage.
5. Remove jumper from J4 to enable the master controller.
6. Vary Load1 from 0 A to 3 A; 1.5-V master output must remain in load regulation.
7. Vary Vin from 2.9 V to 3.5 V; 1.5-V master output must remain in line regulation.
8. Remove jumper from J9 to enable the slave controller.
9. Vary Load2 from 0 A to 3 A; 1.2-V slave output must remain in load regulation.
10. Vary Vin from 2.9 V to 3.5 V; 1.2-V slave output must remain in line regulation.
11. Measure the waveforms of SW_MST (TP6) and SW_SLV (TP18) to see master-slave 180° interleaved.
12. Put jumpers on J4, J9 to disable master and slave controller.
13. Decrease Load1 and Load2 to 0 A.
14. Decrease Vin to 0 V.

6.2 Loop Gain/Phase Measurement

1. Set up the EVM as described in [Section 6.1](#) and [Figure 3](#). Measure 1.5-V bode plot.
2. Connect the isolation transformer to CHA_MST and CHB_MST.
3. Connect input signal CHA to TP1(CHA_MST), and connect output signal CHB to TP2 (CHB_MST).
4. Connect the GND lead of CHA and CHB to TP25(GND).
5. Inject approximately a 50-mV or less signal through the isolate transformer.
6. Sweep the frequency from 500 Hz to 1 MHz with a 10-Hz or lower post filter. The control loop gain and phase margin can be measured.
7. Disconnect isolate transformer from the bode plot setup before making other measurements. (Signal injection into feedback may interfere with accuracy of other measurement.)

8. The loop measurement for 1.2-V slave output is the same with 1.5-V master output.

6.3 List of Test Points

Table 8. Functions of Each Test Points

Test Points	Name	Description
TP1 ⁽¹⁾	CHA_MST	Input A for 1.5-V loop injection
TP2	CHB_MST	Input B for 1.5-V loop injection
TP3	3.3VDD	3.3VDD
TP4	GND	Ground
TP5	Vin_MST	Input voltage for 1.5-V master
TP6	SW_MST	Switching node for 1.5-V master
TP7	Vout_MST	1.5-V output
TP8	GND	Ground
TP9	EN_MST	Enable for 1.5-V master
TP10	GND	Ground
TP11	GND	Ground
TP12	SYNC_MST	SYNC signal for 1.5-V master
TP13	PG_MST	Power Good for 1.5-V master
TP14	CHA_SLV	Input A for 1.2-V loop injection
TP15	CHB_SLV	Input B for 1.2-V loop injection
TP16	Vin_SLV	Input voltage for 1.2-V slave
TP17	GND	Ground
TP18	SW_SLV	Switching node for 1.2-V slave
TP19	Vout_SLV	1.2-V output
TP20	SYNC_SLV	SYNC signal for 1.2-V slave
TP21	GND	Ground
TP22	EN_SLV	Enable for 1.2-V slave
TP23	PG_SLV	Power Good for 1.2-V slave
TP24	GND	Ground
TP25	GND	Ground
TP26	GND	Ground

⁽¹⁾ For test point locations, see [Figure 3](#).

6.4 Equipment Shutdown

1. Shut down load.
2. Shut down Vin.
3. Shut down oscilloscope.

7 Performance Data and Typical Characteristic Curves

[Figure 4](#) through [Figure 17](#) present typical performance curves for TPS53310EVM-755. Jumpers set to default locations; see [Section 6](#).

7.1 Efficiency

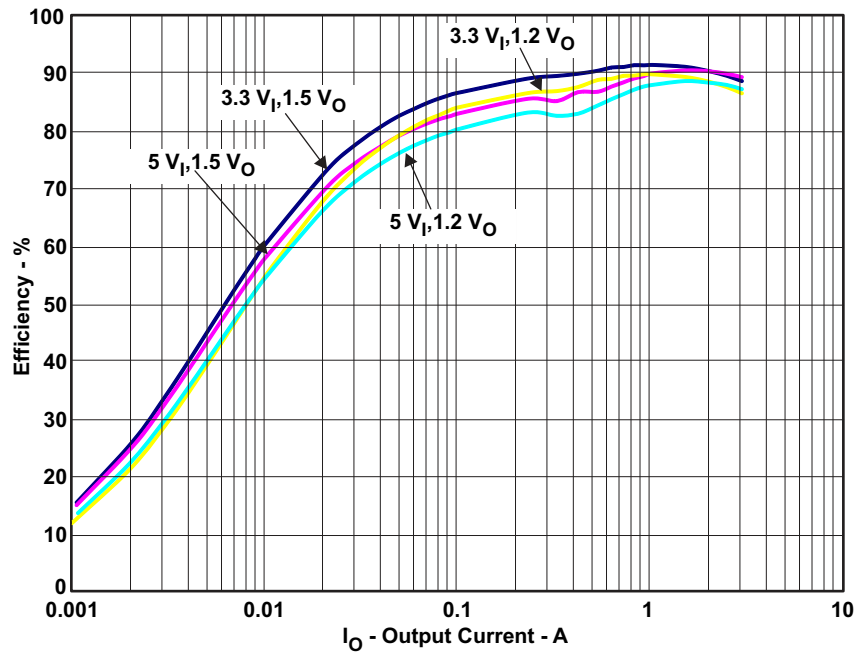

NOTE: R-C snubber to reduce switching node ringing has effect on dc-dc converter efficiency.

Figure 4. TPS53310EVM-755 Efficiency

7.2 Load Regulation

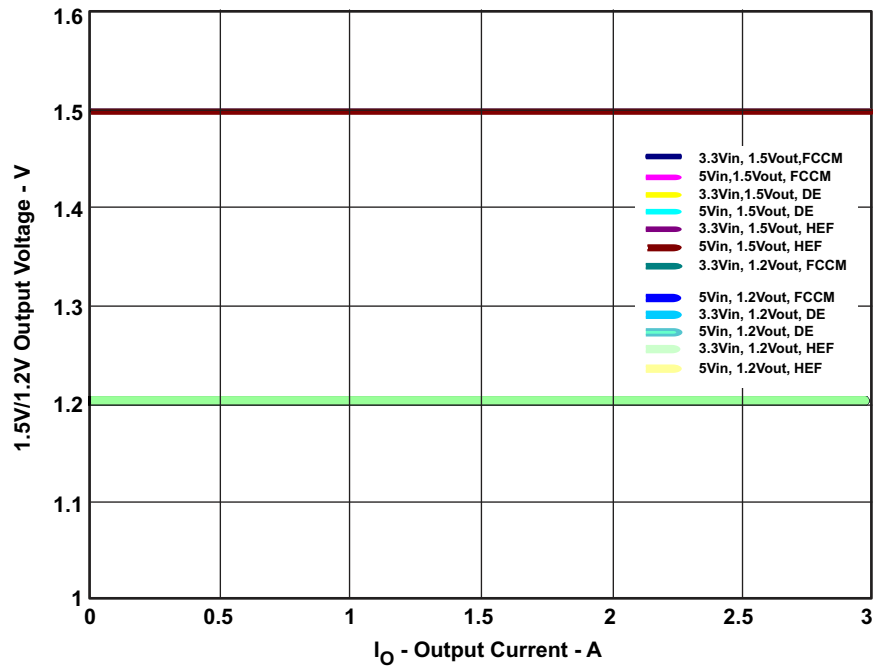

Figure 5. TPS53310EVM-755 Load Regulation

7.3 Line Regulation

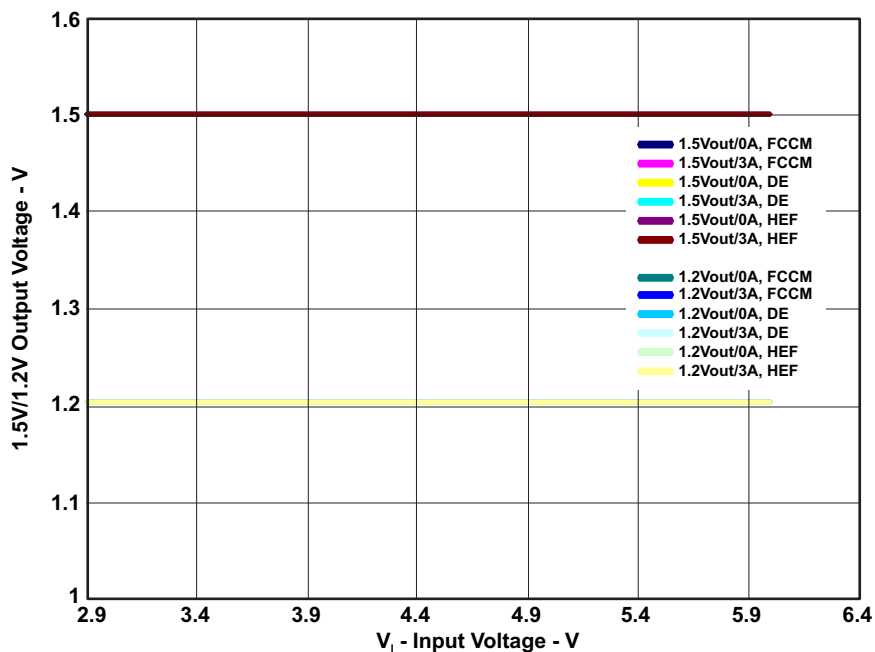

Figure 6. TPS53310EVM-755 Line Regulation

7.4 1.5-V Output Ripple

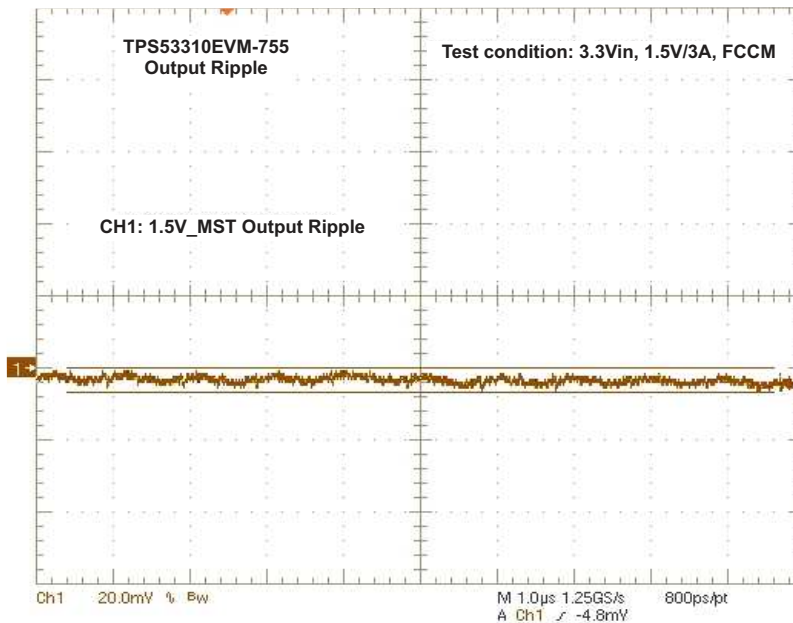

Figure 7. TPS53310EVM-755 Output Ripple (3.3 V_{in}, 1.5 V/3 A)

7.5 1.5-V Switching Node at Full Load

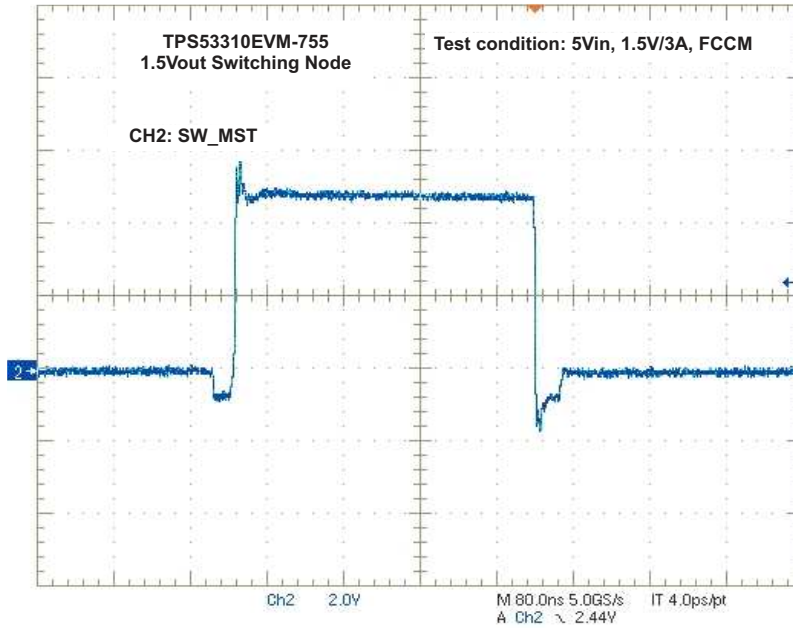

Figure 8. TPS53310EVM-755 Switching Node at Full Load (5 Vin, 1.5 V/3 A)

7.6 1.5-V Switching Node at No Load

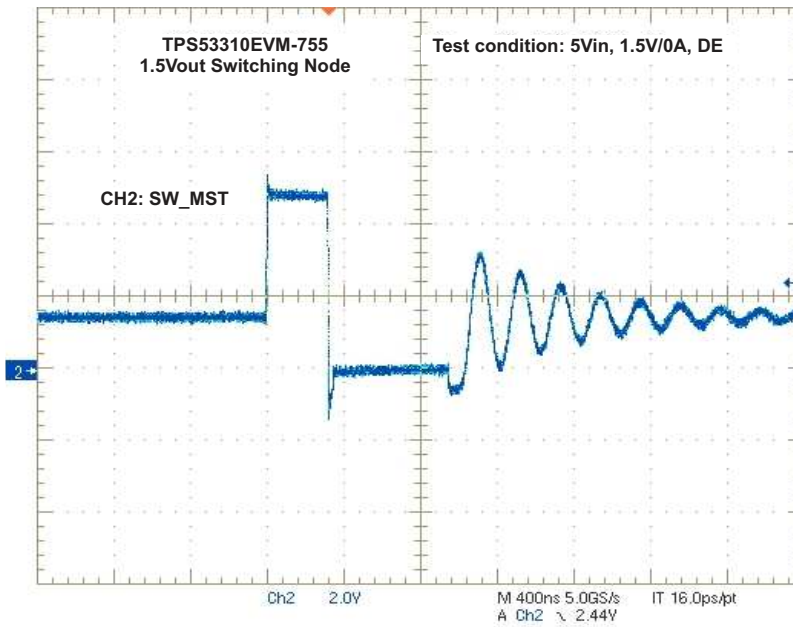

Figure 9. TPS53310EVM-755 Switching Node at No Load (5 Vin, 1.5 V/0 A DE Mode)

7.7 Master-Slave 180° Synchronization

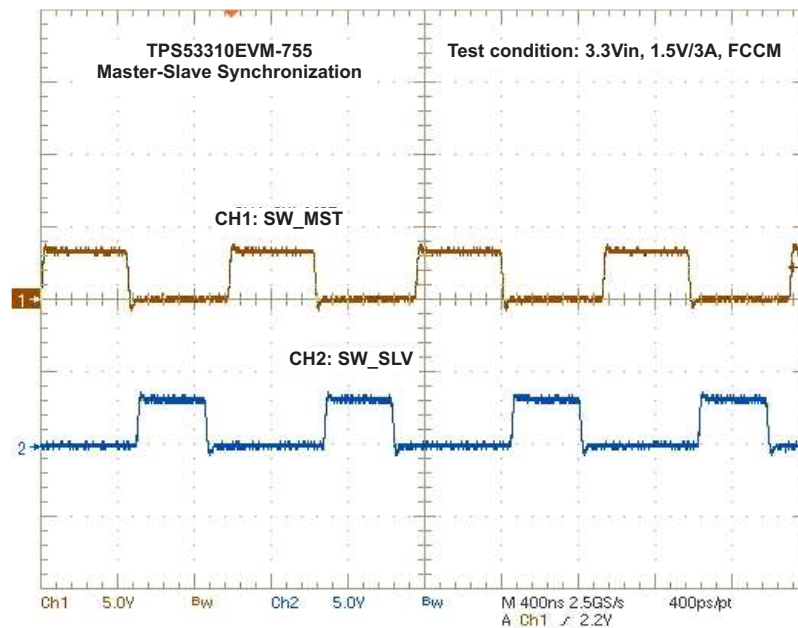

Figure 10. TPS53310EVM-755 Synchronization (3.3 V_{in}, 1.5 V/3 A, 1.2 V/3 A 180° Synchronization)

7.8 1.5-V Master Turnoff During Master-Slave Synchronization

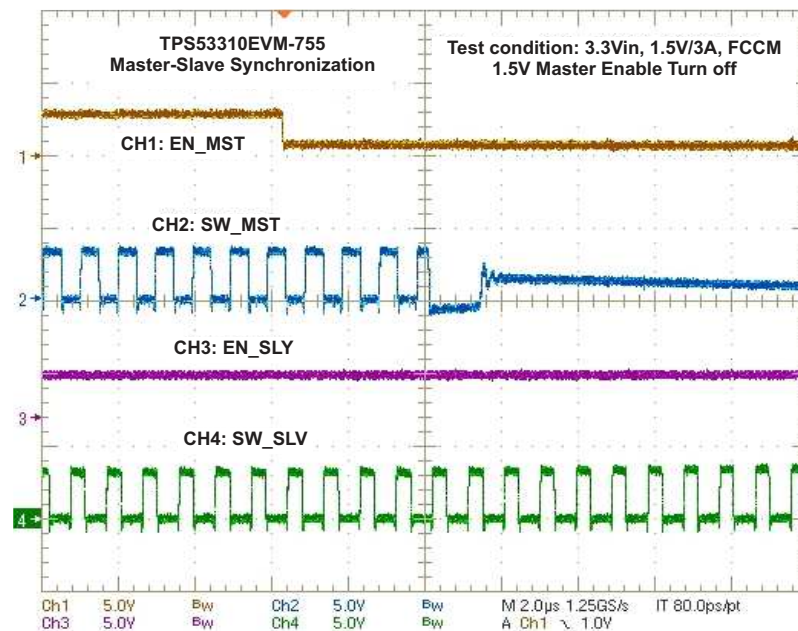

Figure 11. TPS53310EVM-755 Synchronization (3.3 V_{in}, 1.5 V/3 A, 1.2 V/3 A 180° Synchronization, Then Turn Off Master)

7.9 1.5-V Output Transient

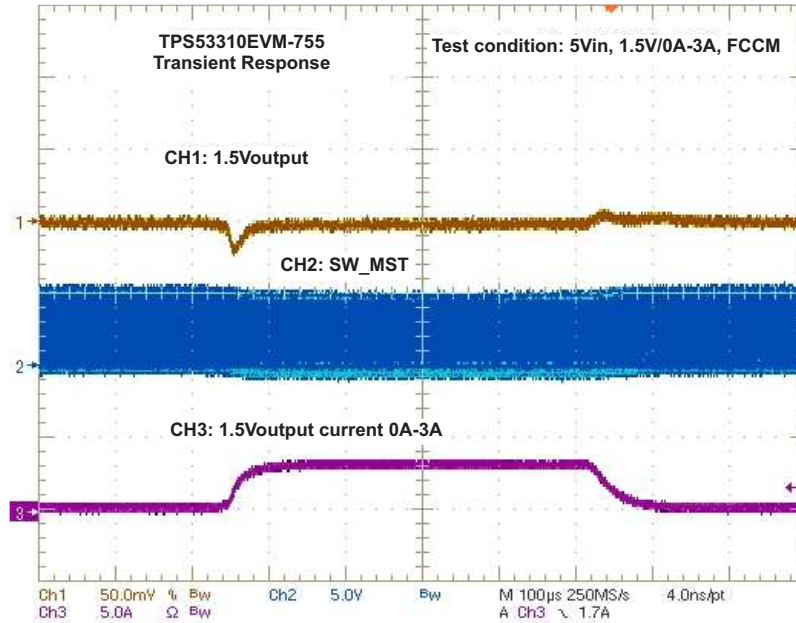

Figure 12. TPS53310EVM-755 1.5-V Output Transient (5 Vin, 1.5 V/0 A-3 A)

7.10 1.5-V Turnon Waveform

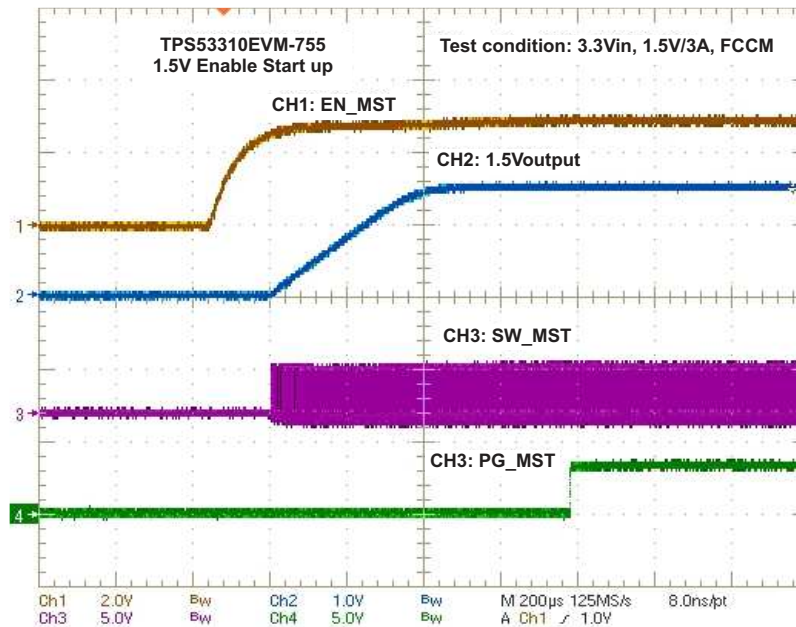

Figure 13. TPS53310EVM-755 Enable Turns On Waveform (3.3 Vin, 1.5 V/3 A)

7.11 1.5-V Turnoff Waveform

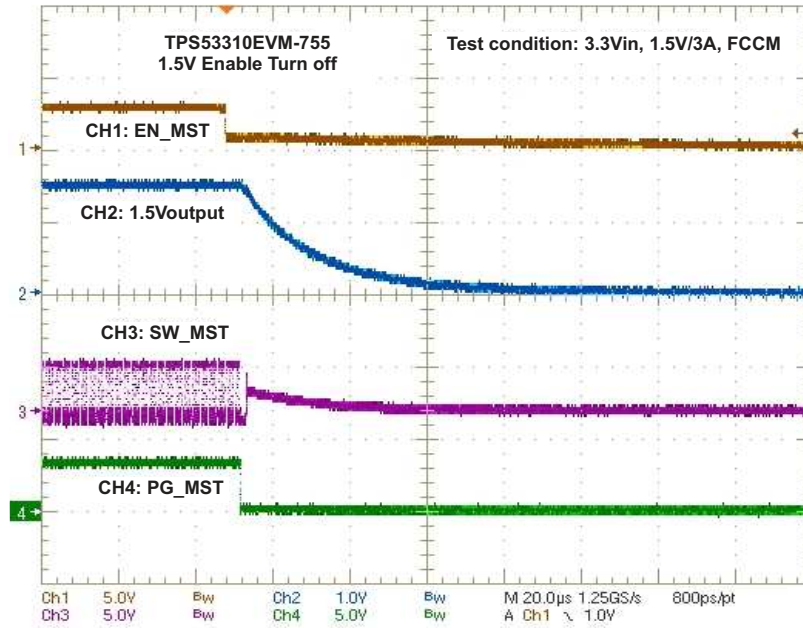

Figure 14. TPS53310EVM-755 Enable Turns Off Waveform (3.3 Vin, 1.5 V/3 A)

7.12 1.5-V Hiccup OCP Waveform

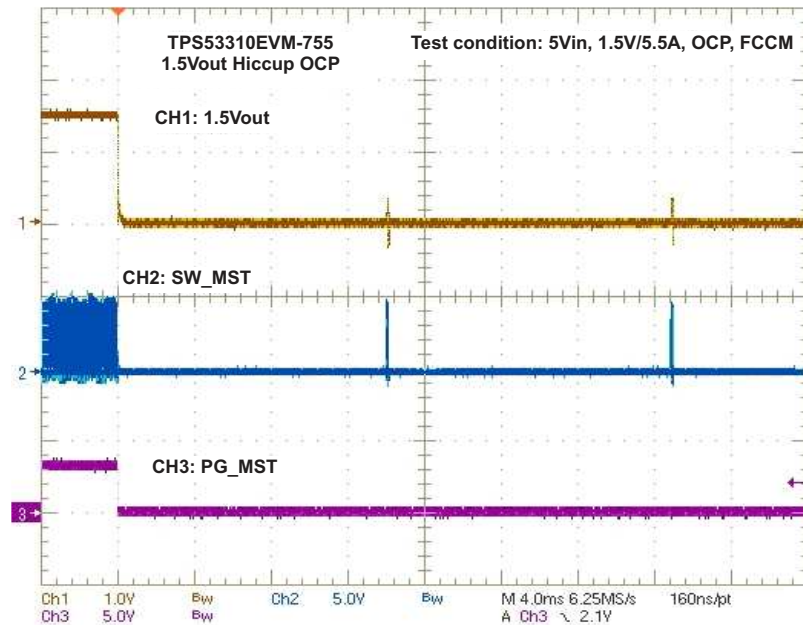

Figure 15. TPS53310EVM-755 Hiccup OCP Waveform (5 Vin, 1.5 V/5.5 A OCP)

7.13 1.5-V Bode Plot

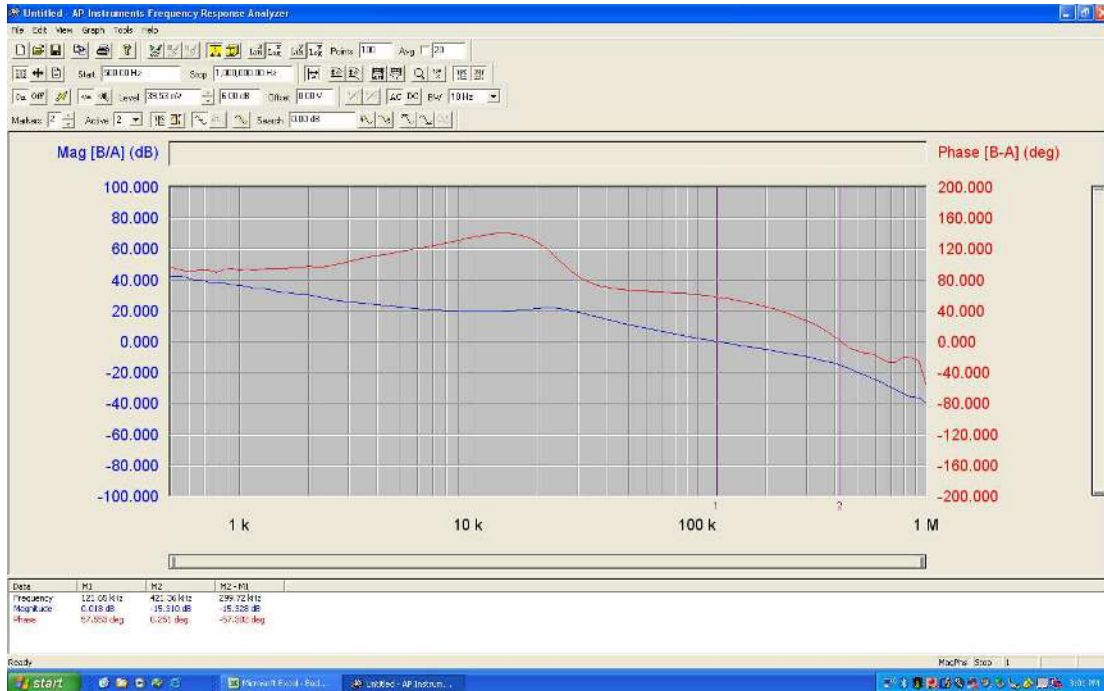

Figure 16. TPS53310EVM-755 Bode Plot (3.3 Vin, 1.5 V/3 A)

7.14 EVM Top Board Thermal Image

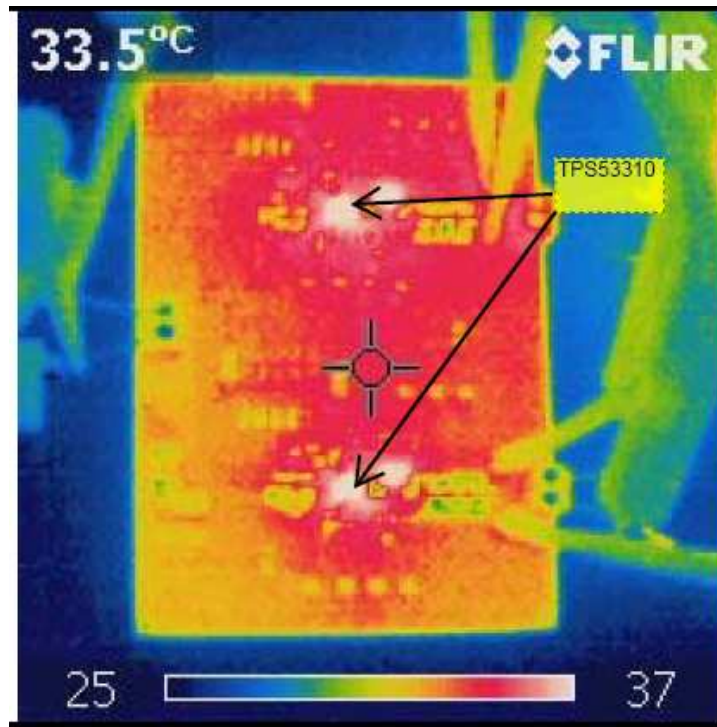

Figure 17. TPS53310EVM-755 Top-Side Thermal Image (3.3 Vin, 1.5 V/3 A, 1.2 V/3 A)

8 EVM Assembly Drawings and PCB Layout

The following figures (Figure 18 through Figure 23) show the design of the TPS53310EVM-755 printed-circuit board. The EVM has been designed using a four-layer circuit board with 2 oz of copper on the outside layers.

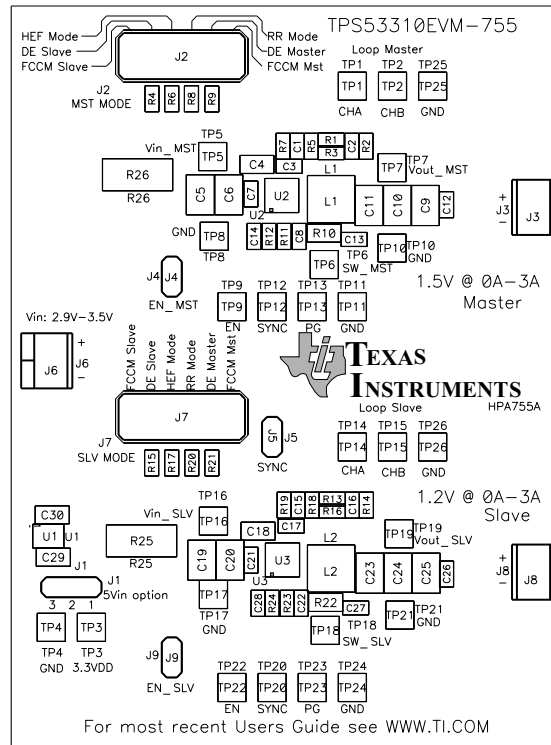

Figure 18. TPS53310EVM-755 Top Layer Assembly Drawing, Top View

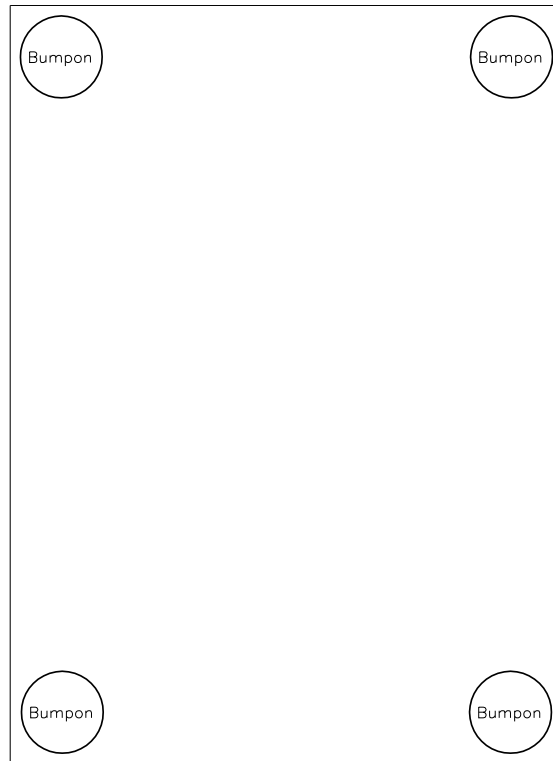

Figure 19. TPS53310EVM-755 Bottom Assembly Drawing, Bottom View

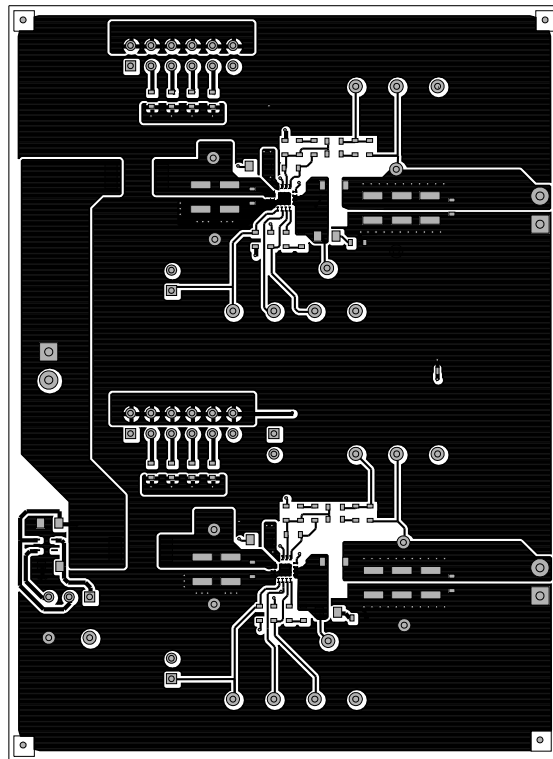

Figure 20. TPS53310EVM-755 Top Copper, Top View

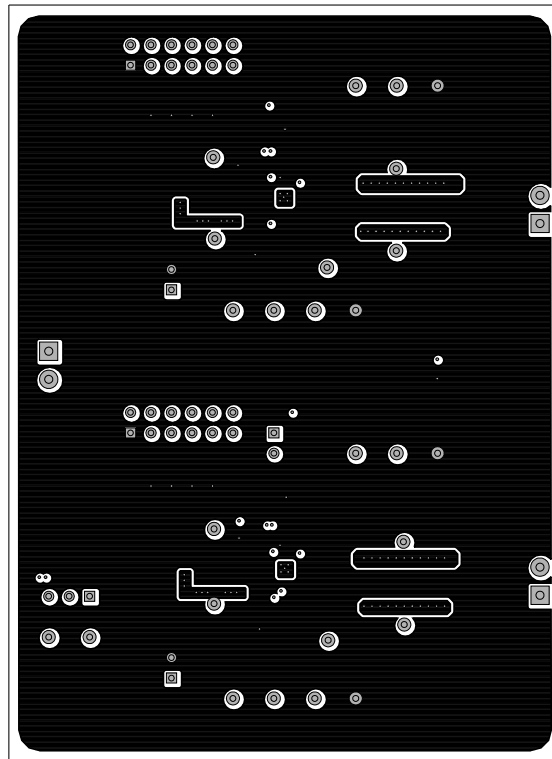

Figure 21. TPS53310EVM-755 Internal Layer 2, Top View

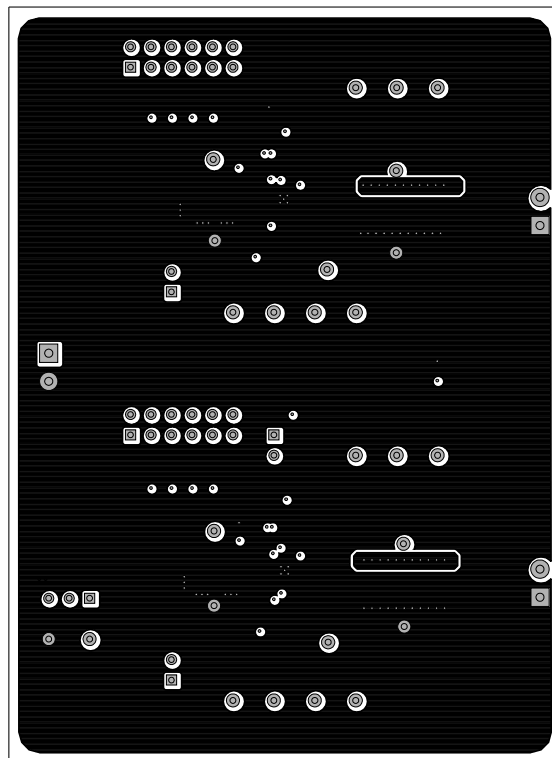

Figure 22. TPS53310EVM-755 Internal Layer 3, Top View

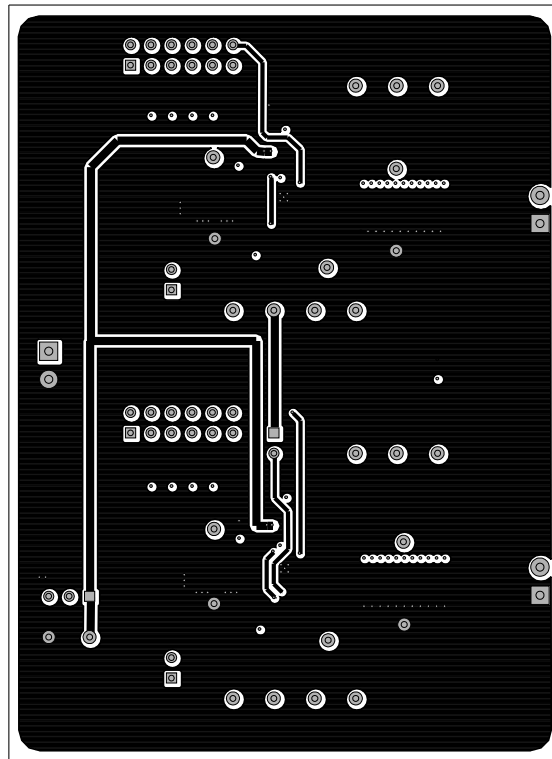

Figure 23. TPS53310EVM-755 Bottom Copper, Top View

9 Bill of Materials

Table 9 shows the EVM major components list according to the schematic shown in Figure 1..

Table 9. Bill of Materials

QTY	RefDes	Description	MFR	Part No.
4	C1, C2, C15, C16	Capacitor, Ceramic, 2.2nF, 50V, X7R, 10%, 0603	STD	STD
2	C13, C27	Capacitor, Ceramic, 820pF, 50V, X7R, 10%, 0603	STD	STD
6	C6, C10, C11,C20, C23, C24	Capacitor, Ceramic, 22µF, 16V, X5R, 10%, 1210	STD	STD
2	C3, C17	Capacitor, Ceramic, 100pF, 50V, C0G, 10%, 0603	STD	STD
4	C4, C18, C29, C30	Capacitor, Ceramic, 10µF, 10V, X5R, 10%, 0805	STD	STD
6	C7, C8, C12, C21, C22, C26	Capacitor, Ceramic, 0.1µF, 25V, X7R, 10%, 0603	STD	STD
2	L1, L2	Inductor, SMT, 1uH, 5.6A, 5.4mohm, 5.0x5.0mm	ICE components	IN06142
5	R1, R5, R13, R18, R19	Resistor, Chip, 4.02k, 1/16W, 1%, 0603	STD	STD
2	R10, R22	Resistor, Chip, 3.01, 1/10W, 5%, 0805	STD	STD
2	R11, R23	Resistor, Chip, 0, 1/16W, 5%, 0603	STD	STD
2	R12, R24	Resistor, Chip, 10.0k, 1/16W, 1%, 0603	STD	STD
2	R2, R14	Resistor, Chip, 10, 1/16W, 1%, 0603	STD	STD
2	R25, R26	Resistor, Chip, 0, 1W, 5%, 2512	STD	STD
2	R3, R16	Resistor, Chip, 20, 1/16W, 1%, 0603	STD	STD
2	R4, R15	Resistor, Chip, 24.3k, 1/16W, 1%,0603	STD	STD
2	R6, R17	Resistor, Chip, 57.6k, 1/16W, 1%,0603	STD	STD
1	R7	Resistor, Chip, 2.67k, 1/16W, 1%,0603	STD	STD
2	R8, R20	Resistor, Chip, 105k, 1/16W, 1%, 0603	STD	STD
2	R9, R21	Resistor, Chip, 174k, 1/16W, 1%, 0603	STD	STD
1	U1	IC, 150mA, Low Iq, Wide bandwidth, LDO Linear regulator, SC70	TI	TPS71733DCKR
1	U2, U3	IC, 3A Step-down regulator with integrated switcher, QFN-16	TI	TPS53310RGT

Evaluation Board/Kit Important Notice

Texas Instruments (TI) provides the enclosed product(s) under the following conditions:

This evaluation board/kit is intended for use for **ENGINEERING DEVELOPMENT, DEMONSTRATION, OR EVALUATION PURPOSES ONLY** and is not considered by TI to be a finished end-product fit for general consumer use. Persons handling the product(s) must have electronics training and observe good engineering practice standards. As such, the goods being provided are not intended to be complete in terms of required design-, marketing-, and/or manufacturing-related protective considerations, including product safety and environmental measures typically found in end products that incorporate such semiconductor components or circuit boards. This evaluation board/kit does not fall within the scope of the European Union directives regarding electromagnetic compatibility, restricted substances (RoHS), recycling (WEEE), FCC, CE or UL, and therefore may not meet the technical requirements of these directives or other related directives.

Should this evaluation board/kit not meet the specifications indicated in the User's Guide, the board/kit may be returned within 30 days from the date of delivery for a full refund. **THE FOREGOING WARRANTY IS THE EXCLUSIVE WARRANTY MADE BY SELLER TO BUYER AND IS IN LIEU OF ALL OTHER WARRANTIES, EXPRESSED, IMPLIED, OR STATUTORY, INCLUDING ANY WARRANTY OF MERCHANTABILITY OR FITNESS FOR ANY PARTICULAR PURPOSE.**

The user assumes all responsibility and liability for proper and safe handling of the goods. Further, the user indemnifies TI from all claims arising from the handling or use of the goods. Due to the open construction of the product, it is the user's responsibility to take any and all appropriate precautions with regard to electrostatic discharge.

EXCEPT TO THE EXTENT OF THE INDEMNITY SET FORTH ABOVE, NEITHER PARTY SHALL BE LIABLE TO THE OTHER FOR ANY INDIRECT, SPECIAL, INCIDENTAL, OR CONSEQUENTIAL DAMAGES.

TI currently deals with a variety of customers for products, and therefore our arrangement with the user **is not exclusive.**

TI assumes **no liability for applications assistance, customer product design, software performance, or infringement of patents or services described herein.**

Please read the User's Guide and, specifically, the Warnings and Restrictions notice in the User's Guide prior to handling the product. This notice contains important safety information about temperatures and voltages. For additional information on TI's environmental and/or safety programs, please contact the TI application engineer or visit www.ti.com/esh.

No license is granted under any patent right or other intellectual property right of TI covering or relating to any machine, process, or combination in which such TI products or services might be or are used.

FCC Warning

This evaluation board/kit is intended for use for **ENGINEERING DEVELOPMENT, DEMONSTRATION, OR EVALUATION PURPOSES ONLY** and is not considered by TI to be a finished end-product fit for general consumer use. It generates, uses, and can radiate radio frequency energy and has not been tested for compliance with the limits of computing devices pursuant to part 15 of FCC rules, which are designed to provide reasonable protection against radio frequency interference. Operation of this equipment in other environments may cause interference with radio communications, in which case the user at his own expense will be required to take whatever measures may be required to correct this interference.

EVM Warnings and Restrictions

It is important to operate this EVM within the input voltage range of 2.9 V to 6 V and the output voltage range of 0 V to 5 V.

Exceeding the specified input range may cause unexpected operation and/or irreversible damage to the EVM. If there are questions concerning the input range, please contact a TI field representative prior to connecting the input power.

Applying loads outside of the specified output range may result in unintended operation and/or possible permanent damage to the EVM. Please consult the EVM User's Guide prior to connecting any load to the EVM output. If there is uncertainty as to the load specification, please contact a TI field representative.

During normal operation, some circuit components may have case temperatures greater than 40°C. The EVM is designed to operate properly with certain components above 40°C as long as the input and output ranges are maintained. These components include but are not limited to linear regulators, switching transistors, pass transistors, and current sense resistors. These types of devices can be identified using the EVM schematic located in the EVM User's Guide. When placing measurement probes near these devices during operation, please be aware that these devices may be very warm to the touch.

Mailing Address: Texas Instruments, Post Office Box 655303, Dallas, Texas 75265
Copyright © 2012, Texas Instruments Incorporated

EVALUATION BOARD/KIT/MODULE (EVM) ADDITIONAL TERMS

Texas Instruments (TI) provides the enclosed Evaluation Board/Kit/Module (EVM) under the following conditions:

The user assumes all responsibility and liability for proper and safe handling of the goods. Further, the user indemnifies TI from all claims arising from the handling or use of the goods.

Should this evaluation board/kit not meet the specifications indicated in the User's Guide, the board/kit may be returned within 30 days from the date of delivery for a full refund. THE FOREGOING LIMITED WARRANTY IS THE EXCLUSIVE WARRANTY MADE BY SELLER TO BUYER AND IS IN LIEU OF ALL OTHER WARRANTIES, EXPRESSED, IMPLIED, OR STATUTORY, INCLUDING ANY WARRANTY OF MERCHANTABILITY OR FITNESS FOR ANY PARTICULAR PURPOSE. EXCEPT TO THE EXTENT OF THE INDEMNITY SET FORTH ABOVE, NEITHER PARTY SHALL BE LIABLE TO THE OTHER FOR ANY INDIRECT, SPECIAL, INCIDENTAL, OR CONSEQUENTIAL DAMAGES.

Please read the User's Guide and, specifically, the Warnings and Restrictions notice in the User's Guide prior to handling the product. This notice contains important safety information about temperatures and voltages. For additional information on TI's environmental and/or safety programs, please visit www.ti.com/esh or contact TI.

No license is granted under any patent right or other intellectual property right of TI covering or relating to any machine, process, or combination in which such TI products or services might be or are used. TI currently deals with a variety of customers for products, and therefore our arrangement with the user is not exclusive. TI assumes no liability for applications assistance, customer product design, software performance, or infringement of patents or services described herein.

REGULATORY COMPLIANCE INFORMATION

As noted in the EVM User's Guide and/or EVM itself, this EVM and/or accompanying hardware may or may not be subject to the Federal Communications Commission (FCC) and Industry Canada (IC) rules.

For EVMs **not** subject to the above rules, this evaluation board/kit/module is intended for use for ENGINEERING DEVELOPMENT, DEMONSTRATION OR EVALUATION PURPOSES ONLY and is not considered by TI to be a finished end product fit for general consumer use. It generates, uses, and can radiate radio frequency energy and has not been tested for compliance with the limits of computing devices pursuant to part 15 of FCC or ICES-003 rules, which are designed to provide reasonable protection against radio frequency interference. Operation of the equipment may cause interference with radio communications, in which case the user at his own expense will be required to take whatever measures may be required to correct this interference.

General Statement for EVMs including a radio

User Power/Frequency Use Obligations: This radio is intended for development/professional use only in legally allocated frequency and power limits. Any use of radio frequencies and/or power availability of this EVM and its development application(s) must comply with local laws governing radio spectrum allocation and power limits for this evaluation module. It is the user's sole responsibility to only operate this radio in legally acceptable frequency space and within legally mandated power limitations. Any exceptions to this are strictly prohibited and unauthorized by Texas Instruments unless user has obtained appropriate experimental/development licenses from local regulatory authorities, which is responsibility of user including its acceptable authorization.

For EVMs annotated as FCC – FEDERAL COMMUNICATIONS COMMISSION Part 15 Compliant

Caution

This device complies with part 15 of the FCC Rules. Operation is subject to the following two conditions: (1) This device may not cause harmful interference, and (2) this device must accept any interference received, including interference that may cause undesired operation.

Changes or modifications not expressly approved by the party responsible for compliance could void the user's authority to operate the equipment.

FCC Interference Statement for Class A EVM devices

This equipment has been tested and found to comply with the limits for a Class A digital device, pursuant to part 15 of the FCC Rules. These limits are designed to provide reasonable protection against harmful interference when the equipment is operated in a commercial environment. This equipment generates, uses, and can radiate radio frequency energy and, if not installed and used in accordance with the instruction manual, may cause harmful interference to radio communications. Operation of this equipment in a residential area is likely to cause harmful interference in which case the user will be required to correct the interference at his own expense.

FCC Interference Statement for Class B EVM devices

This equipment has been tested and found to comply with the limits for a Class B digital device, pursuant to part 15 of the FCC Rules. These limits are designed to provide reasonable protection against harmful interference in a residential installation. This equipment generates, uses and can radiate radio frequency energy and, if not installed and used in accordance with the instructions, may cause harmful interference to radio communications. However, there is no guarantee that interference will not occur in a particular installation. If this equipment does cause harmful interference to radio or television reception, which can be determined by turning the equipment off and on, the user is encouraged to try to correct the interference by one or more of the following measures:

- Reorient or relocate the receiving antenna.
- Increase the separation between the equipment and receiver.
- Connect the equipment into an outlet on a circuit different from that to which the receiver is connected.
- Consult the dealer or an experienced radio/TV technician for help.

For EVMs annotated as IC – INDUSTRY CANADA Compliant

This Class A or B digital apparatus complies with Canadian ICES-003.

Changes or modifications not expressly approved by the party responsible for compliance could void the user's authority to operate the equipment.

Concerning EVMs including radio transmitters

This device complies with Industry Canada licence-exempt RSS standard(s). Operation is subject to the following two conditions: (1) this device may not cause interference, and (2) this device must accept any interference, including interference that may cause undesired operation of the device.

Concerning EVMs including detachable antennas

Under Industry Canada regulations, this radio transmitter may only operate using an antenna of a type and maximum (or lesser) gain approved for the transmitter by Industry Canada. To reduce potential radio interference to other users, the antenna type and its gain should be so chosen that the equivalent isotropically radiated power (e.i.r.p.) is not more than that necessary for successful communication.

This radio transmitter has been approved by Industry Canada to operate with the antenna types listed in the user guide with the maximum permissible gain and required antenna impedance for each antenna type indicated. Antenna types not included in this list, having a gain greater than the maximum gain indicated for that type, are strictly prohibited for use with this device.

Cet appareil numérique de la classe A ou B est conforme à la norme NMB-003 du Canada.

Les changements ou les modifications pas expressément approuvés par la partie responsable de la conformité ont pu vider l'autorité de l'utilisateur pour actionner l'équipement.

Concernant les EVMs avec appareils radio

Le présent appareil est conforme aux CNR d'Industrie Canada applicables aux appareils radio exempts de licence. L'exploitation est autorisée aux deux conditions suivantes : (1) l'appareil ne doit pas produire de brouillage, et (2) l'utilisateur de l'appareil doit accepter tout brouillage radioélectrique subi, même si le brouillage est susceptible d'en compromettre le fonctionnement.

Concernant les EVMs avec antennes détachables

Conformément à la réglementation d'Industrie Canada, le présent émetteur radio peut fonctionner avec une antenne d'un type et d'un gain maximal (ou inférieur) approuvé pour l'émetteur par Industrie Canada. Dans le but de réduire les risques de brouillage radioélectrique à l'intention des autres utilisateurs, il faut choisir le type d'antenne et son gain de sorte que la puissance isotrope rayonnée équivalente (p.i.r.e.) ne dépasse pas l'intensité nécessaire à l'établissement d'une communication satisfaisante.

Le présent émetteur radio a été approuvé par Industrie Canada pour fonctionner avec les types d'antenne énumérés dans le manuel d'usage et ayant un gain admissible maximal et l'impédance requise pour chaque type d'antenne. Les types d'antenne non inclus dans cette liste, ou dont le gain est supérieur au gain maximal indiqué, sont strictement interdits pour l'exploitation de l'émetteur.

【Important Notice for Users of this Product in Japan】

This development kit is NOT certified as Confirming to Technical Regulations of Radio Law of Japan

If you use this product in Japan, you are required by Radio Law of Japan to follow the instructions below with respect to this product:

1. Use this product in a shielded room or any other test facility as defined in the notification #173 issued by Ministry of Internal Affairs and Communications on March 28, 2006, based on Sub-section 1.1 of Article 6 of the Ministry's Rule for Enforcement of Radio Law of Japan,
2. Use this product only after you obtained the license of Test Radio Station as provided in Radio Law of Japan with respect to this product, or
3. Use of this product only after you obtained the Technical Regulations Conformity Certification as provided in Radio Law of Japan with respect to this product. Also, please do not transfer this product, unless you give the same notice above to the transferee. Please note that if you could not follow the instructions above, you will be subject to penalties of Radio Law of Japan.

Texas Instruments Japan Limited
(address) 24-1, Nishi-Shinjuku 6 chome, Shinjuku-ku, Tokyo, Japan

<http://www.tij.co.jp>

【ご使用にあたっての注】

本開発キットは技術基準適合証明を受けておりません。

本製品のご使用に際しては、電波法遵守のため、以下のいずれかの措置を取っていただく必要がありますのでご注意ください。

1. 電波法施行規則第6条第1項第1号に基づく平成18年3月28日総務省告示第173号で定められた電波暗室等の試験設備でご使用いただく。
2. 実験局の免許を取得後ご使用いただく。
3. 技術基準適合証明を取得後ご使用いただく。

なお、本製品は、上記の「ご使用にあたっての注意」を譲渡先、移転先に通知しない限り、譲渡、移転できないものとします。

上記を遵守頂けない場合は、電波法の罰則が適用される可能性があることをご留意ください。

日本テキサス・インスツルメンツ株式会社
東京都新宿区西新宿6丁目24番1号
西新宿三井ビル

<http://www.tij.co.jp>

EVALUATION BOARD/KIT/MODULE (EVM) WARNINGS, RESTRICTIONS AND DISCLAIMERS

For Feasibility Evaluation Only, in Laboratory/Development Environments. Unless otherwise indicated, this EVM is not a finished electrical equipment and not intended for consumer use. It is intended solely for use for preliminary feasibility evaluation in laboratory/development environments by technically qualified electronics experts who are familiar with the dangers and application risks associated with handling electrical mechanical components, systems and subsystems. It should not be used as all or part of a finished end product.

Your Sole Responsibility and Risk. You acknowledge, represent and agree that:

1. You have unique knowledge concerning Federal, State and local regulatory requirements (including but not limited to Food and Drug Administration regulations, if applicable) which relate to your products and which relate to your use (and/or that of your employees, affiliates, contractors or designees) of the EVM for evaluation, testing and other purposes.
2. You have full and exclusive responsibility to assure the safety and compliance of your products with all such laws and other applicable regulatory requirements, and also to assure the safety of any activities to be conducted by you and/or your employees, affiliates, contractors or designees, using the EVM. Further, you are responsible to assure that any interfaces (electronic and/or mechanical) between the EVM and any human body are designed with suitable isolation and means to safely limit accessible leakage currents to minimize the risk of electrical shock hazard.
3. You will employ reasonable safeguards to ensure that your use of the EVM will not result in any property damage, injury or death, even if the EVM should fail to perform as described or expected.
4. You will take care of proper disposal and recycling of the EVM's electronic components and packing materials.

Certain Instructions. It is important to operate this EVM within TI's recommended specifications and environmental considerations per the user guidelines. Exceeding the specified EVM ratings (including but not limited to input and output voltage, current, power, and environmental ranges) may cause property damage, personal injury or death. If there are questions concerning these ratings please contact a TI field representative prior to connecting interface electronics including input power and intended loads. Any loads applied outside of the specified output range may result in unintended and/or inaccurate operation and/or possible permanent damage to the EVM and/or interface electronics. Please consult the EVM User's Guide prior to connecting any load to the EVM output. If there is uncertainty as to the load specification, please contact a TI field representative. During normal operation, some circuit components may have case temperatures greater than 60°C as long as the input and output are maintained at a normal ambient operating temperature. These components include but are not limited to linear regulators, switching transistors, pass transistors, and current sense resistors which can be identified using the EVM schematic located in the EVM User's Guide. When placing measurement probes near these devices during normal operation, please be aware that these devices may be very warm to the touch. As with all electronic evaluation tools, only qualified personnel knowledgeable in electronic measurement and diagnostics normally found in development environments should use these EVMs.

Agreement to Defend, Indemnify and Hold Harmless. You agree to defend, indemnify and hold TI, its licensors and their representatives harmless from and against any and all claims, damages, losses, expenses, costs and liabilities (collectively, "Claims") arising out of or in connection with any use of the EVM that is not in accordance with the terms of the agreement. This obligation shall apply whether Claims arise under law of tort or contract or any other legal theory, and even if the EVM fails to perform as described or expected.

Safety-Critical or Life-Critical Applications. If you intend to evaluate the components for possible use in safety critical applications (such as life support) where a failure of the TI product would reasonably be expected to cause severe personal injury or death, such as devices which are classified as FDA Class III or similar classification, then you must specifically notify TI of such intent and enter into a separate Assurance and Indemnity Agreement.

Mailing Address: Texas Instruments, Post Office Box 655303, Dallas, Texas 75265
Copyright © 2012, Texas Instruments Incorporated

IMPORTANT NOTICE

Texas Instruments Incorporated and its subsidiaries (TI) reserve the right to make corrections, enhancements, improvements and other changes to its semiconductor products and services per JESD46, latest issue, and to discontinue any product or service per JESD48, latest issue. Buyers should obtain the latest relevant information before placing orders and should verify that such information is current and complete. All semiconductor products (also referred to herein as "components") are sold subject to TI's terms and conditions of sale supplied at the time of order acknowledgment.

TI warrants performance of its components to the specifications applicable at the time of sale, in accordance with the warranty in TI's terms and conditions of sale of semiconductor products. Testing and other quality control techniques are used to the extent TI deems necessary to support this warranty. Except where mandated by applicable law, testing of all parameters of each component is not necessarily performed.

TI assumes no liability for applications assistance or the design of Buyers' products. Buyers are responsible for their products and applications using TI components. To minimize the risks associated with Buyers' products and applications, Buyers should provide adequate design and operating safeguards.

TI does not warrant or represent that any license, either express or implied, is granted under any patent right, copyright, mask work right, or other intellectual property right relating to any combination, machine, or process in which TI components or services are used. Information published by TI regarding third-party products or services does not constitute a license to use such products or services or a warranty or endorsement thereof. Use of such information may require a license from a third party under the patents or other intellectual property of the third party, or a license from TI under the patents or other intellectual property of TI.

Reproduction of significant portions of TI information in TI data books or data sheets is permissible only if reproduction is without alteration and is accompanied by all associated warranties, conditions, limitations, and notices. TI is not responsible or liable for such altered documentation. Information of third parties may be subject to additional restrictions.

Resale of TI components or services with statements different from or beyond the parameters stated by TI for that component or service voids all express and any implied warranties for the associated TI component or service and is an unfair and deceptive business practice. TI is not responsible or liable for any such statements.

Buyer acknowledges and agrees that it is solely responsible for compliance with all legal, regulatory and safety-related requirements concerning its products, and any use of TI components in its applications, notwithstanding any applications-related information or support that may be provided by TI. Buyer represents and agrees that it has all the necessary expertise to create and implement safeguards which anticipate dangerous consequences of failures, monitor failures and their consequences, lessen the likelihood of failures that might cause harm and take appropriate remedial actions. Buyer will fully indemnify TI and its representatives against any damages arising out of the use of any TI components in safety-critical applications.

In some cases, TI components may be promoted specifically to facilitate safety-related applications. With such components, TI's goal is to help enable customers to design and create their own end-product solutions that meet applicable functional safety standards and requirements. Nonetheless, such components are subject to these terms.

No TI components are authorized for use in FDA Class III (or similar life-critical medical equipment) unless authorized officers of the parties have executed a special agreement specifically governing such use.

Only those TI components which TI has specifically designated as military grade or "enhanced plastic" are designed and intended for use in military/aerospace applications or environments. Buyer acknowledges and agrees that any military or aerospace use of TI components which have **not** been so designated is solely at the Buyer's risk, and that Buyer is solely responsible for compliance with all legal and regulatory requirements in connection with such use.

TI has specifically designated certain components which meet ISO/TS16949 requirements, mainly for automotive use. Components which have not been so designated are neither designed nor intended for automotive use; and TI will not be responsible for any failure of such components to meet such requirements.

Products

Audio	www.ti.com/audio
Amplifiers	amplifier.ti.com
Data Converters	dataconverter.ti.com
DLP® Products	www.dlp.com
DSP	dsp.ti.com
Clocks and Timers	www.ti.com/clocks
Interface	interface.ti.com
Logic	logic.ti.com
Power Mgmt	power.ti.com
Microcontrollers	microcontroller.ti.com
RFID	www.ti-rfid.com
OMAP Applications Processors	www.ti.com/omap
Wireless Connectivity	www.ti.com/wirelessconnectivity

Applications

Automotive and Transportation	www.ti.com/automotive
Communications and Telecom	www.ti.com/communications
Computers and Peripherals	www.ti.com/computers
Consumer Electronics	www.ti.com/consumer-apps
Energy and Lighting	www.ti.com/energy
Industrial	www.ti.com/industrial
Medical	www.ti.com/medical
Security	www.ti.com/security
Space, Avionics and Defense	www.ti.com/space-avionics-defense
Video and Imaging	www.ti.com/video

TI E2E Community

e2e.ti.com