

UCC27624-Q1 30-V, 5-A, Dual-Channel, Low-Side Gate Driver with –10-V Input Capability For Automotive Applications

1 Features

- Qualified for Automotive Applications
- AEC-Q100 Qualified
 - Device Temperature Grade 1
 - Device HBM ESD Classification Level H1C
 - Device CDM ESD Classification Level C6
- Typical 5-A peak source and sink drive current for each channel
- Input and enable pins capable of handling –10 V
- Output capable of handling –2-V transients
- Absolute maximum VDD voltage: 30 V
- Wide VDD operating range from 4.5 V to 26 V with UVLO
- Hysteretic-logic thresholds for high noise immunity
- VDD independent input thresholds (TTL compatible)
- Fast propagation delays (17-ns typical)
- Fast rise and fall times (6-ns and 10-ns typical)
- 1-ns typical delay matching between the two channels
- Two channels can be paralleled for higher drive current
- SOIC8 and VSSOP8 PowerPAD™ package options
- Operating junction temperature range of –40°C to 150°C

2 Applications

- [Automotive DC/DC Converters](#)
- [Switched-mode power supplies \(SMPS\)](#)
- [Power factor correction \(PFC\) circuits](#)
- [DC/DC converter](#)
- [Motor drives](#)
- [Solar power supplies](#)
- [Pulse transformer driver](#)

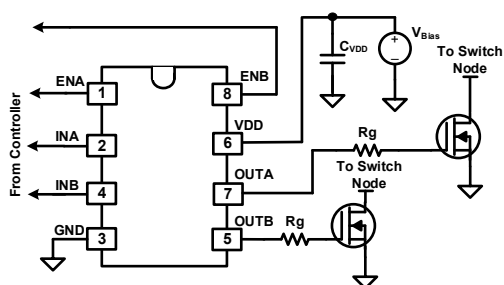

Simplified Application Diagram

3 Description

The UCC27624-Q1 is a dual-channel, high-speed, low-side gate driver that effectively drives MOSFET, IGBT, SiC, and GaN power switches. UCC27624-Q1 has a typical peak drive strength of 5 A, which reduces rise and fall times of the power switches, lowers switching losses, and increases efficiency. The device's fast propagation delay (17-ns typical) yields better power stage efficiency by improving the deadtime optimization, pulse width utilization, control loop response, and transient performance of the system.

UCC27624-Q1 can handle –10 V at its inputs, which improves robustness in systems with moderate ground bouncing. The inputs are independent of supply voltage and can be connected to most controller outputs for maximum control flexibility. An independent enable signal allows the power stage to be controlled independently of main control logic. In the event of a system fault, the gate driver can quickly shut-off by pulling enable low. Many high-frequency switching power supplies exhibit noise at the gate of the power device, which can get injected into the output pin on the gate driver and can cause the driver to malfunction. The device's transient reverse current and reverse voltage capability allow it to tolerate noise on the gate of the power device or pulse-transformer and avoid driver malfunction.

The UCC27624-Q1 also features undervoltage lockout (UVLO) for improved system robustness. When there is not enough bias voltage to fully enhance the power device, the gate driver output is held low by the strong internal pull down MOSFET.

Device Information

PART NUMBER ⁽¹⁾	PACKAGE	BODY SIZE (NOM)
UCC27624-Q1	SOIC (8)	4.90 mm × 3.91 mm
UCC27624-Q1	VSSOP (8)	3.00 mm × 3.00 mm

(1) For all available packages, see the orderable addendum at the end of the data sheet.



Table of Contents

1 Features	1	7.4 Device Functional Modes.....	16
2 Applications	1	8 Application and Implementation	17
3 Description	1	8.1 Application Information.....	17
4 Revision History	2	8.2 Typical Application.....	18
5 Pin Configuration and Functions	3	9 Power Supply Recommendations	22
6 Specifications	4	10 Layout	23
6.1 Absolute Maximum Ratings.....	4	10.1 Layout Guidelines.....	23
6.2 ESD Ratings.....	4	10.2 Layout Example.....	24
6.3 Recommended Operating Conditions.....	4	10.3 Thermal Considerations.....	24
6.4 Thermal Information.....	4	11 Device and Documentation Support	25
6.5 Electrical Characteristics.....	5	11.1 Third-Party Products Disclaimer.....	25
6.6 Switching Characteristics.....	6	11.2 Receiving Notification of Documentation Updates..	25
6.7 Timing Diagrams.....	7	11.3 Support Resources.....	25
6.8 Typical Characteristics.....	8	11.4 Trademarks.....	25
7 Detailed Description	12	11.5 Electrostatic Discharge Caution.....	25
7.1 Overview.....	12	11.6 Glossary.....	25
7.2 Functional Block Diagram.....	13	12 Mechanical, Packaging, and Orderable Information	25
7.3 Feature Description.....	13		

4 Revision History

NOTE: Page numbers for previous revisions may differ from page numbers in the current version.

Changes from Revision A (May 2022) to Revision B (November 2022)	Page
• Changed status from Advance Information to Production Data.....	1

Changes from Revision * (March 2022) to Revision A (May 2022)	Page
• Added automotive certifications.....	1
• Updated ESD ratings.....	4

5 Pin Configuration and Functions

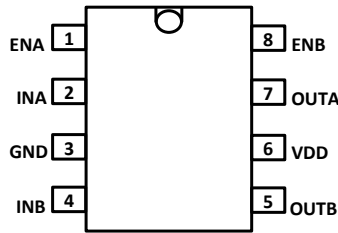

Figure 5-1. D Package 8-Pin SOIC Top View

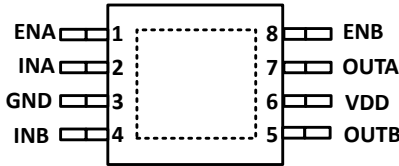

Figure 5-2. DGN Package 8-Pin VSSOP Top View

Table 5-1. Pin Functions

PIN			TYPE ⁽¹⁾	DESCRIPTION
NAME	DGN	D		
ENA	1	1	I	Enable input for Channel A. Biasing ENA, LOW will disable Channel A output regardless of the state of INA. Pulling ENA, HIGH enables the Channel A output. If ENA is left floating, Channel A is enabled by default due to an internal pullup resistor. It is recommended to connect this pin to VDD if unused.
ENB	8	8	I	Enable input for Channel B. Biasing ENB, LOW disables Channel B output regardless of the state of INB. Pulling ENB, HIGH enables the Channel B output. If ENB is left floating, Channel B is enabled by default due to an internal pullup resistor. It is recommended to connect this pin to VDD if unused.
GND	3	3	—	Ground: All signals are referenced to this pin.
INA	2	2	I	Input to Channel A. INA is the non-inverting input of the UCC27624-Q1 device. OUTA is held LOW if INA is unbiased or floating by default due to an internal pulldown resistor. Connect this pin to GND if unused.
INB	4	4	I	Input to Channel B. INB is the non-inverting input of the UCC27624-Q1 device. OUTB is held LOW if INB is unbiased or floating by default due to an internal pulldown resistor. Connect this pin to GND if unused.
OUTA	7	7	O	Channel A Output
OUTB	5	5	O	Channel B Output
VDD	6	6	I	Bias supply input. Bypass this pin with two ceramic capacitors, generally $\geq 1 \mu\text{F}$ and $0.1 \mu\text{F}$, which are referenced to GND pin of this device.
	Thermal Pad	—	—	Connect to GND through large copper plane. This pad is not a low-impedance path to GND.

(1) I = Input; O = Output

6 Specifications

6.1 Absolute Maximum Ratings

over operating free-air temperature range (unless otherwise noted)^{(1) (2) (3)}

		MIN	MAX	UNIT
Supply voltage, VDD		-0.3	30	V
Output Voltage, OUTA, OUTB	DC	-0.3	VDD +0.3	V
	200ns Pulse	-2	VDD +3	V
Input Voltage INA, INB, ENA, ENB		-10	30	V
Operating junction temperature, T _J		-40	150	°C
Lead temperature	Soldering, 10 sec.		300	°C
	Reflow		260	
Storage temperature, T _{stg}		-65	150	°C

- (1) Operation outside the Absolute Maximum Ratings may cause permanent device damage. Absolute Maximum Ratings do not imply functional operation of the device at these or any other conditions beyond those listed under Recommended Operating Conditions. If outside the Recommended Operating Conditions but within the Absolute Maximum Ratings, the device may not be fully functional, and this may affect device reliability, functionality, performance, and shorten the device lifetime.
- (2) All voltages are with respect to GND unless otherwise noted. Currents are positive into, negative out of the specified terminal. See [Section 6.4](#) of the datasheet for thermal limitations and considerations of packages.
- (3) These devices are sensitive to electrostatic discharge; follow proper device handling procedures.

6.2 ESD Ratings

		VALUE	UNIT
V _(ESD) Electrostatic discharge	Human body model (HBM), per AEC Q100-002 ⁽¹⁾	±2000	V
	Charged-device model (CDM), per AEC Q100-011	±1000	

- (1) AEC Q100-002 indicates that HBM stressing shall be in accordance with the ANSI/ESDA/JEDEC JS-001 specification.

6.3 Recommended Operating Conditions

over operating free-air temperature range. All voltages are with reference to GND (unless otherwise noted)

		MIN	NOM	MAX	UNIT
Supply voltage, VDD		4.5	12	26	V
Input voltage, INA, INB, ENA, ENB		-10		26	V
Output Voltage, OUTA, OUTB		0		VDD	V
Operating junction temperature, T _J		-40		150	°C

6.4 Thermal Information

THERMAL METRIC		UCC27624-Q1		UNIT
		DGN	D	
		8 PINS	8 PINS	
R _{θJA}	Junction-to-ambient thermal resistance	48.9	126.4	°C/W
R _{θJC(top)}	Junction-to-case (top) thermal resistance	71.8	67.0	
R _{θJB}	Junction-to-board thermal resistance	22.3	69.9	
ψ _{JT}	Junction-to-top characterization parameter	2.6	19.2	
ψ _{JB}	Junction-to-board characterization parameter	22.3	69.1	
R _{θJC(bot)}	Junction-to-case (bottom) thermal resistance	4.5	n/a	

6.5 Electrical Characteristics

Unless otherwise noted, VDD = 12 V, T_A = T_J = –40°C to 150°C, 1-μF capacitor from VDD to GND, no load on the output. Typical condition specifications are at 25°C.

PARAMETER		TEST CONDITIONS	MIN	TYP	MAX	UNIT
BIAS CURRENTS						
I _{VDDq}	VDD quiescent supply current	V _{INx} = 3.3 V, VDD = 3.4 V, ENx = VDD		300	450	μA
I _{VDD}	VDD static supply current	V _{INx} = 3.3 V, ENx = VDD		0.6	1.0	mA
I _{VDD}	VDD static supply current	V _{INx} = 0 V, ENx = VDD		0.7	1.0	mA
I _{VDDO}	VDD operating current	f _{SW} = 1000 kHz, ENx = VDD, V _{INx} = 0 V – 3.3 V PWM		3.2	3.8	mA
I _{DIS}	VDD disable current	V _{INx} = 3.3 V, ENx = 0 V		0.8	1.1	mA
UNDERVOLTAGE LOCKOUT (UVLO)						
V _{VDD_ON}	VDD UVLO rising threshold		3.8	4.1	4.4	V
V _{VDD_OFF}	VDD UVLO falling threshold		3.5	3.8	4.1	V
V _{VDD_HYS}	VDD UVLO hysteresis			0.3		V
INPUT (INA, INB)						
V _{INx_H}	Input signal high threshold	Output High, ENx = HIGH	1.8	2	2.3	V
V _{INx_L}	Input signal low threshold	Output Low, ENx = HIGH	0.8	1	1.2	V
V _{INx_HYS}	Input signal hysteresis			1		V
R _{INx}	INx pin pulldown resistor	INx = 3.3 V		120		kΩ
ENABLE (ENA, ENB)						
V _{ENx_H}	Enable signal high threshold	Output High, INx = HIGH	1.8	2	2.3	V
V _{ENx_L}	Enable signal low threshold	Output Low, INx = HIGH	0.8	1	1.2	V
V _{ENx_HYS}	Enable signal hysteresis			1		V
R _{ENx}	EN pin pullup resistance	ENx = 0 V		200		kΩ
OUTPUTS (OUTA, OUTB)						
I _{SRC} ⁽¹⁾	Peak output source current	VDD = 12 V, C _{VDD} = 10 μF, C _L = 0.1 μF, f = 1 kHz		5		A
I _{SNK} ⁽¹⁾	Peak output sink current	VDD = 12 V, C _{VDD} = 10 μF, C _L = 0.1 μF, f = 1 kHz		–5		A
R _{OH} ⁽²⁾	Pullup resistance	I _{OUT} = –50 mA See Section 7.3.4 .		5	8.5	Ω
R _{OL}	Pulldown resistance	I _{OUT} = 50 mA		0.6	1.1	Ω

(1) Parameter not tested in production.

(2) Output pullup resistance in this table is a DC measurement that measures resistance of PMOS structure only (not N-channel structure).

6.6 Switching Characteristics

Unless otherwise noted, $V_{DD} = V_{EN} = 12\text{ V}$, $T_A = T_J = -40^\circ\text{C}$ to 150°C , $1\text{-}\mu\text{F}$ capacitor from V_{DD} to GND , no load on the output. Typical condition specifications are at 25°C (1).

PARAMETER		TEST CONDITIONS	MIN	TYP	MAX	UNIT
t_{Rx}	Rise time	$C_{LOAD} = 1.8\text{ nF}$, 20% to 80%, $V_{in} = 0\text{ V} - 3.3\text{ V}$		6	10	ns
t_{Fx}	Fall time	$C_{LOAD} = 1.8\text{ nF}$, 90% to 10%, $V_{in} = 0\text{ V} - 3.3\text{ V}$		10	14	ns
t_{D1x}	Turn-on propagation delay	$C_{LOAD} = 1.8\text{ nF}$, V_{INx_H} of the input rise to 10% of output rise, $V_{in} = 0\text{ V} - 3.3\text{ V}$, $F_{sw} = 500\text{ kHz}$, 50% duty cycle, $T_J = 125^\circ\text{C}$		17	27	ns
t_{D2x}	Turn-off propagation delay	$C_{LOAD} = 1.8\text{ nF}$, V_{INx_L} of the input fall to 90% of output fall, $V_{in} = 0\text{ V} - 3.3\text{ V}$, $F_{sw} = 500\text{ kHz}$, 50% duty cycle, $T_J = 125^\circ\text{C}$		17	27	ns
t_{D3x}	Enable propagation delay	$C_{LOAD} = 1.8\text{ nF}$, V_{ENx_H} of the enable rise to 10% of output rise, $V_{in} = 0\text{ V} - 3.3\text{ V}$, $F_{sw} = 500\text{ kHz}$, 50% duty cycle, $T_J = 125^\circ\text{C}$		17	27	ns
t_{D4x}	Disable propagation delay	$C_{LOAD} = 1.8\text{ nF}$, V_{ENx_L} of the enable fall to 90% of output fall, $V_{in} = 0\text{ V} - 3.3\text{ V}$, $F_{sw} = 500\text{ kHz}$, 50% duty cycle, $T_J = 125^\circ\text{C}$		17	27	ns
t_M	Delay matching between two channels	$C_{LOAD} = 1.8\text{ nF}$, $V_{in} = 0\text{ V} - 3.3\text{ V}$, $F_{sw} = 500\text{ kHz}$, 50% duty cycle, $INA = INB$, $ t_{RA} - t_{RB} $, $ t_{FA} - t_{FB} $		1	2	ns
t_{PWmin}	Minimum input pulse width	$C_L = 1.8\text{ nF}$, $V_{in} = 0\text{ V} - 3.3\text{ V}$, $F_{sw} = 500\text{ kHz}$, $V_o > 1.5\text{ V}$		10	15	ns

(1) Switching parameters are not tested in production.

6.7 Timing Diagrams

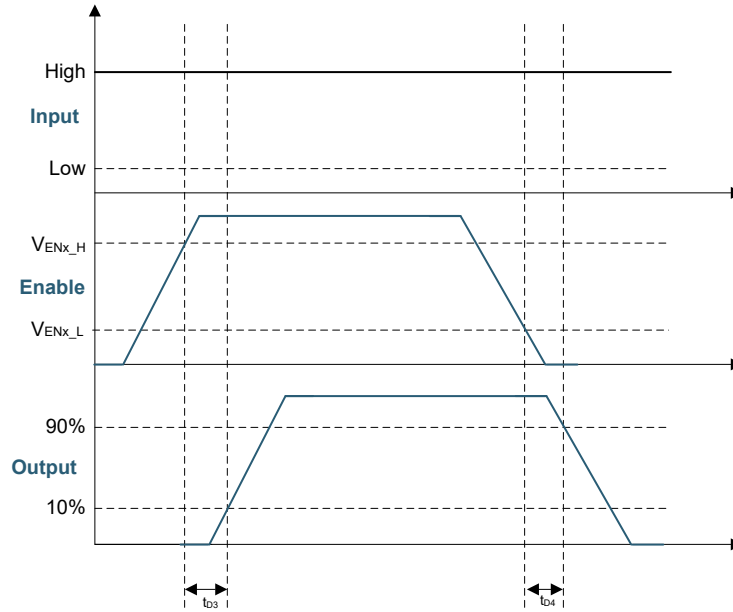

Figure 6-1. Enable Function

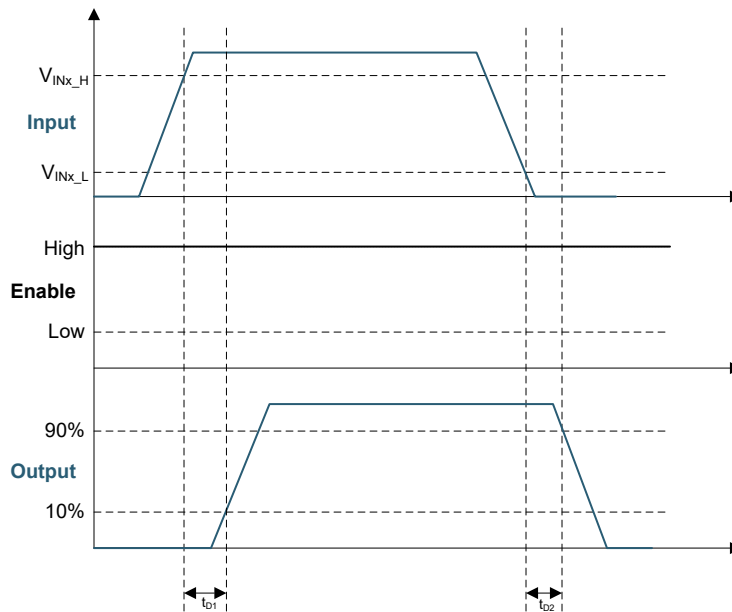

Figure 6-2. Input-Output Operation

6.8 Typical Characteristics

Unless otherwise specified, VDD=12 V, INx = 3.3 V, ENx = 3.3 V, T_J = 25°C, no load

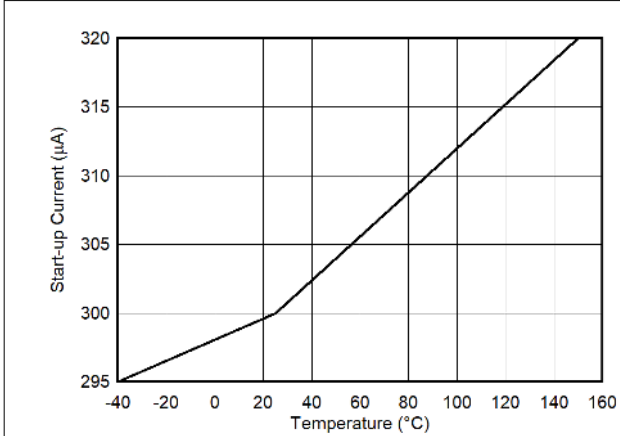

Figure 6-3. Start-Up and Quiescent Current

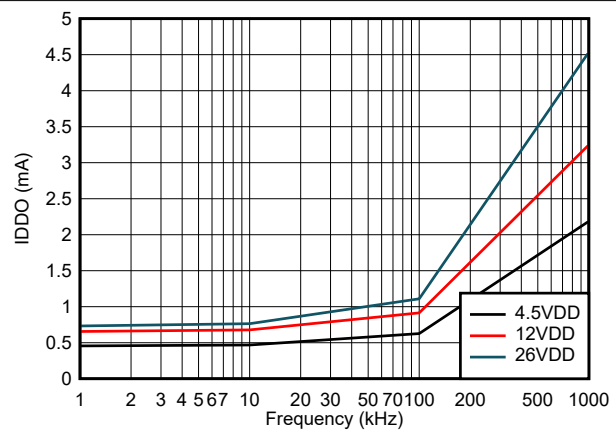

Figure 6-4. Operating Supply Current (Both Outputs Switching)

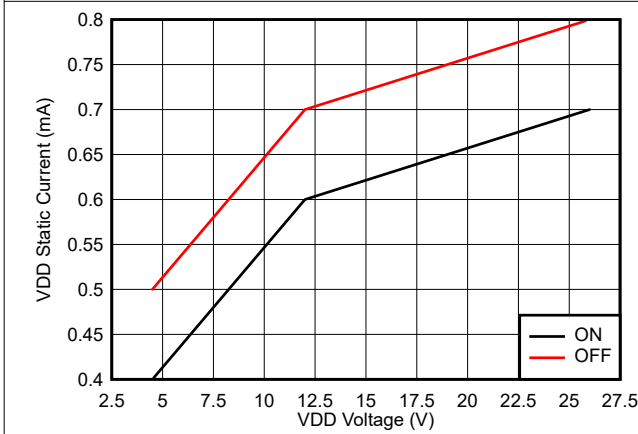

Figure 6-5. Static Supply Current (Outputs in DC On or Off Condition)

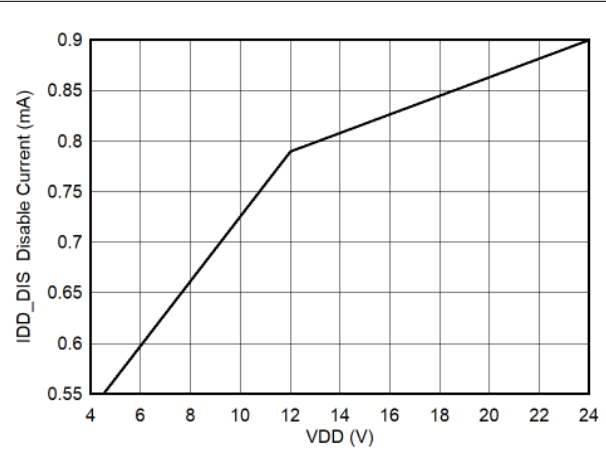

Figure 6-6. Disable Current (EN = 0 V)

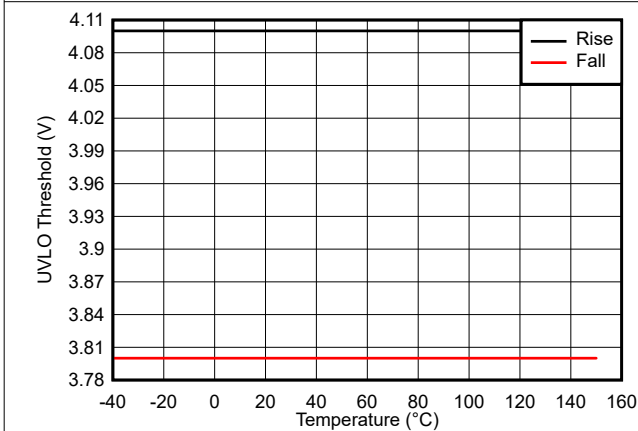

Figure 6-7. VDD UVLO Threshold

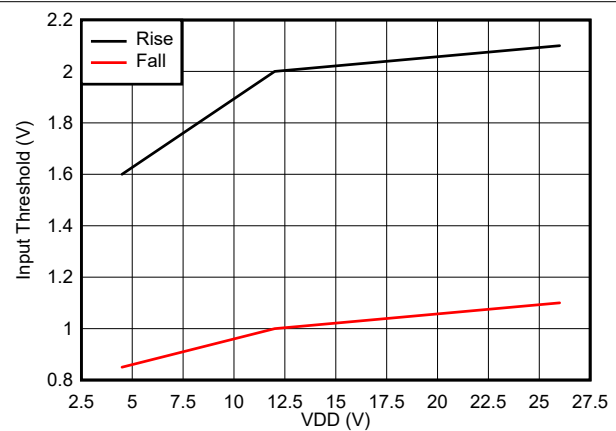
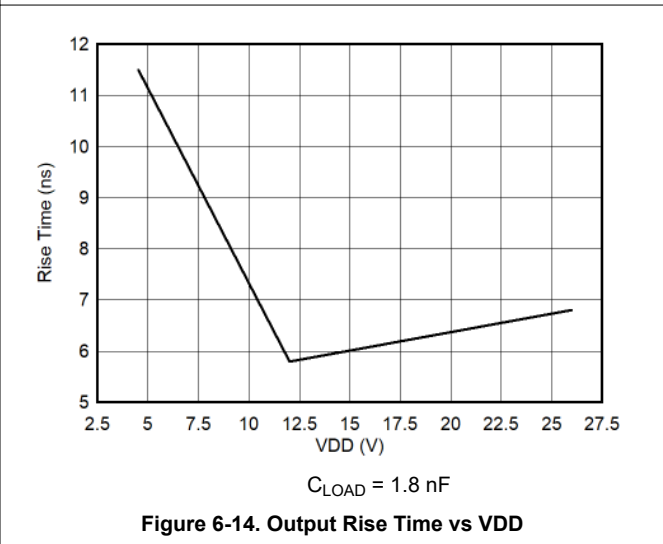
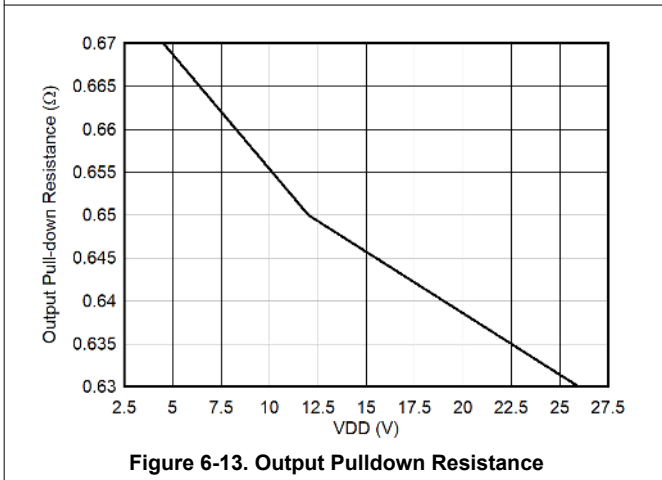
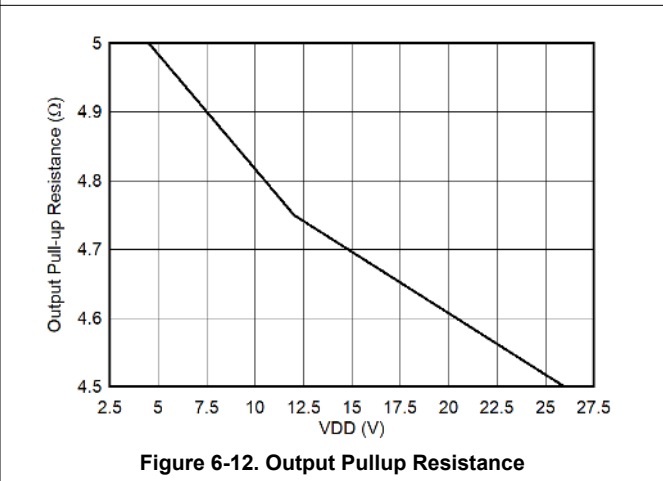
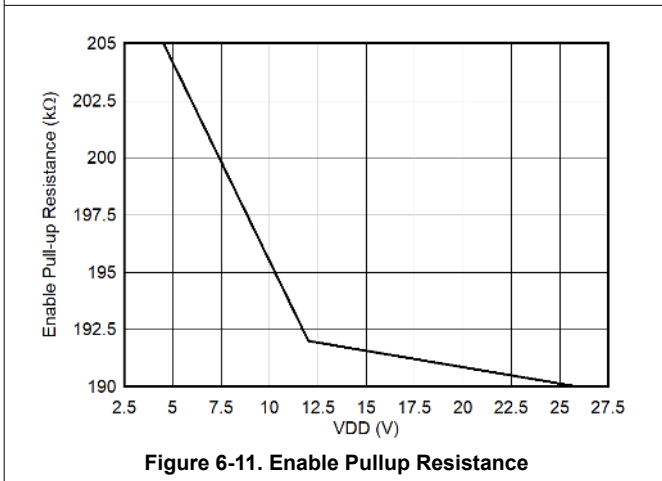
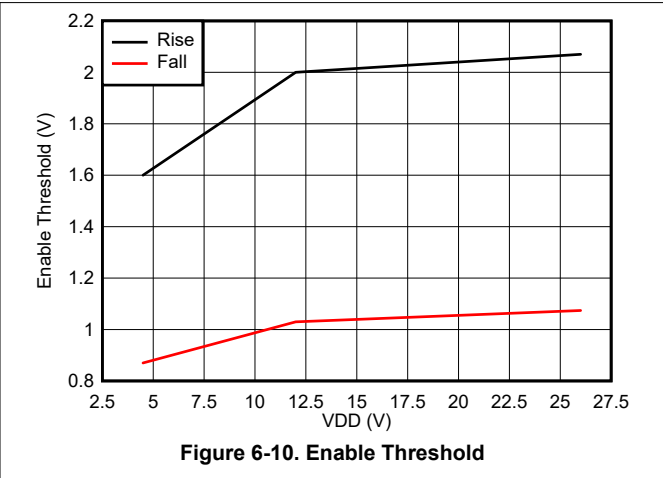
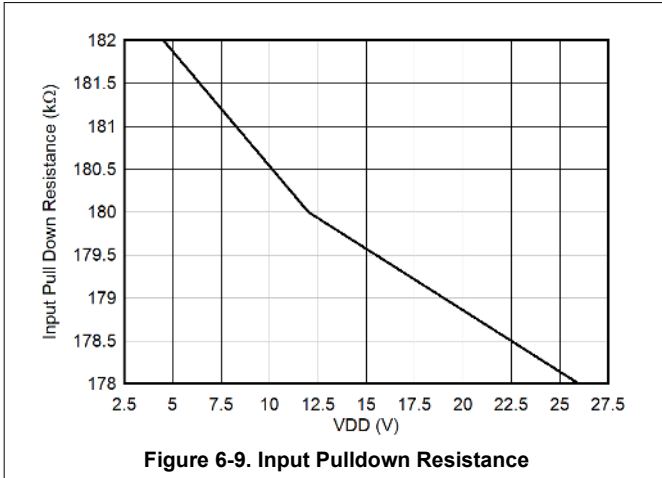

Figure 6-8. Input Thresholds

6.8 Typical Characteristics (continued)

Unless otherwise specified, VDD=12 V, INx = 3.3 V, ENx = 3.3 V, T_J = 25°C, no load



6.8 Typical Characteristics (continued)

Unless otherwise specified, VDD=12 V, INx = 3.3 V, ENx = 3.3 V, T_J = 25°C, no load

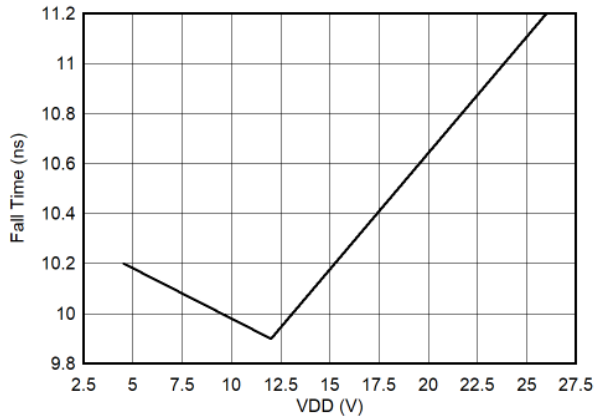

Figure 6-15. Output Fall Time vs VDD

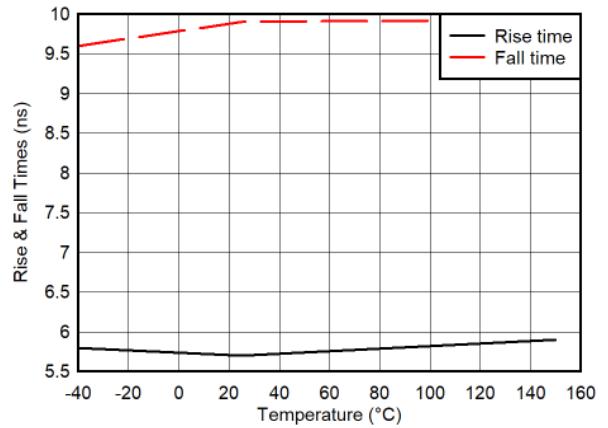

Figure 6-16. Output Rise and Fall Time vs Temperature

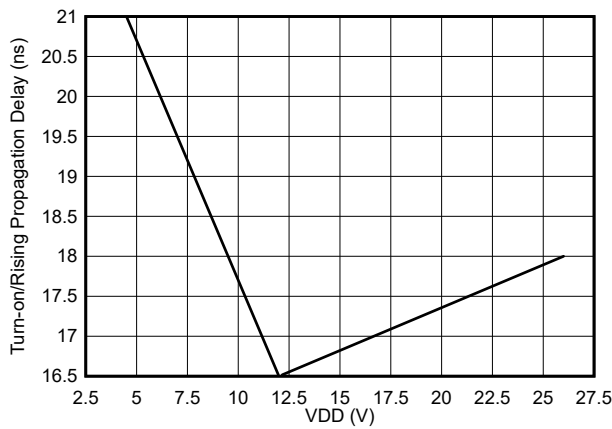

Figure 6-17. Input to Output Rising (Turn-On) Propagation Delay vs VDD

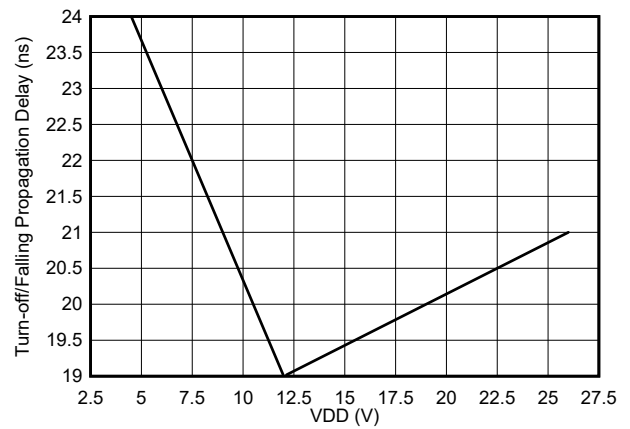

Figure 6-18. Input to Output Falling (Turn-Off) Propagation Delay vs VDD

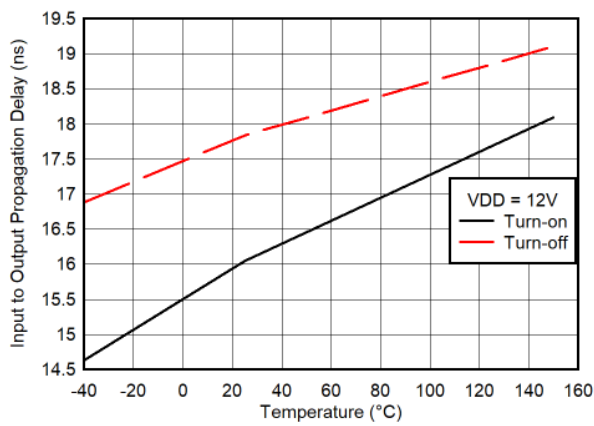

Figure 6-19. Input Propagation Delay vs Temperature

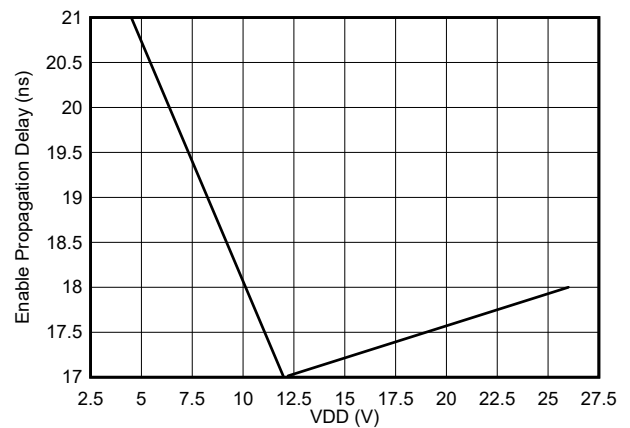
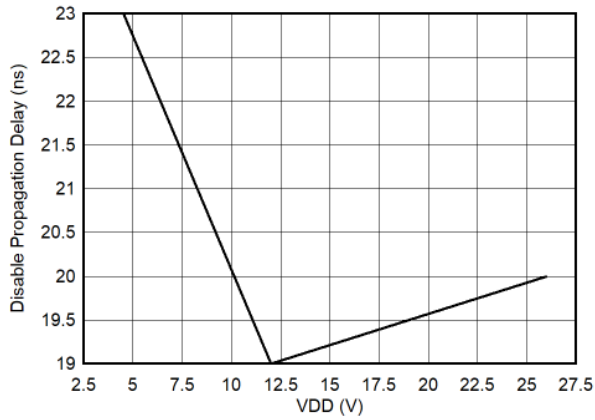

Figure 6-20. Enable to Output Rising Propagation Delay

6.8 Typical Characteristics (continued)

Unless otherwise specified, VDD=12 V, INx = 3.3 V, ENx = 3.3 V, T_J = 25°C, no load



C_{LOAD} = 1.8 nF

Figure 6-21. Enable to Output Falling Propagation Delay

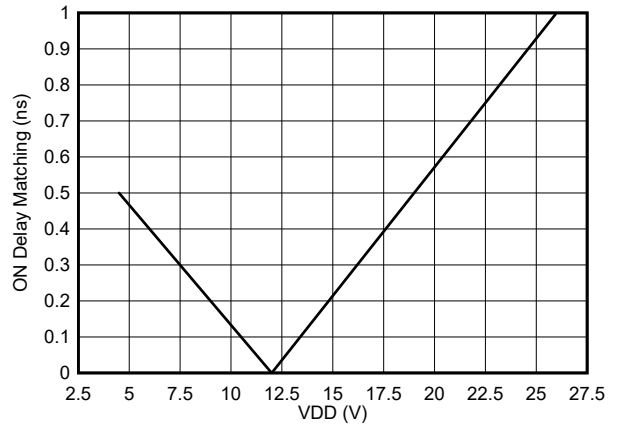

Figure 6-22. Turn-on/Rising Delay Matching

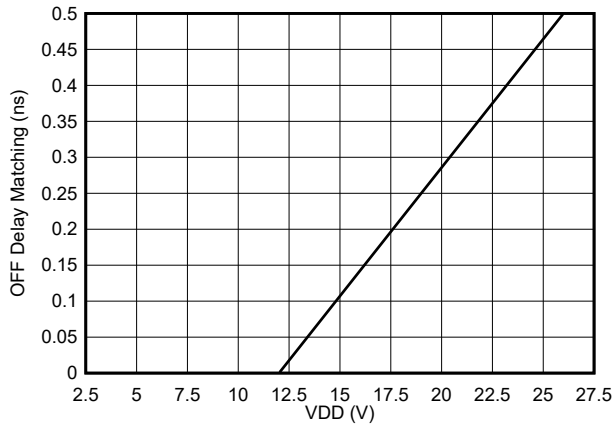

Figure 6-23. Turn-Off and Falling Delay Matching

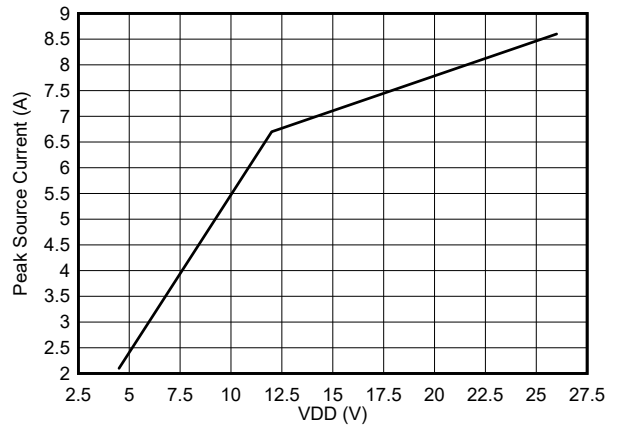

Figure 6-24. Peak Source Current vs VDD

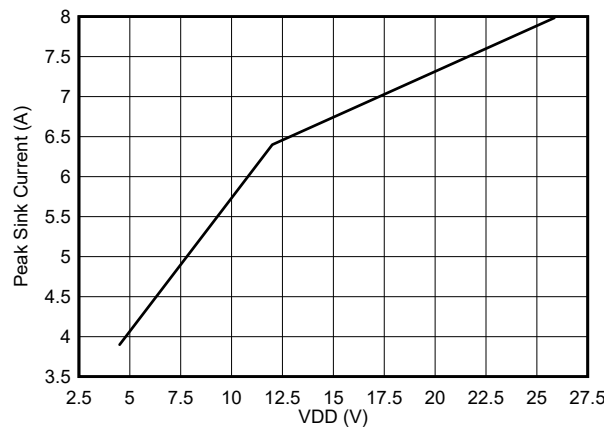

Figure 6-25. Peak Sink Current vs VDD

7 Detailed Description

7.1 Overview

The UCC27624-Q1 device represents TI's latest generation of dual-channel, low-side, high-speed, gate driver devices featuring 5-A source and sink current capability, fast switching characteristics, and a host of other features. [UCC27624-Q1 Features and Benefits](#) details the advantages of the gate driver's features, which combine to ensure efficient, robust, and reliable operation in high-frequency switching power circuits. The robust inputs of UCC27624-Q1 can handle -10 V, ensuring reliable operation in noisy environments. The driver has good transient handling capability on its output due to its reverse current handling, as well as rail-to-rail output drive, and a small propagation delay (typically 17 ns). With this built-in robustness, the UCC27624-Q1 device can also be directly connected to a gate drive transformer.

The input threshold of UCC27624-Q1 is compatible with TTL low-voltage logic, which is fixed and independent of VDD supply voltage. The driver can also work with CMOS-based controllers as long as the threshold requirement is met. The 1-V typical hysteresis offers excellent noise immunity.

Each channel has an enable pin, ENx, with a fixed TTL compatible threshold. The ENx pins are internally pulled up. Pulling ENx low disables the corresponding channel, while leaving ENx open provides normal operation. The ENx pins can be used as an additional input with the same performance as the INx pins.

Table 7-1. UCC27624-Q1 Features and Benefits

FEATURE	BENEFIT
-10 -V IN and EN capability	Enhanced signal reliability and device robustness in noisy environments that experience ground bounce on the gate driver
17-ns (typical) propagation delay	Extremely low-pulse transmission distortion
1-ns (typical) delay matching between channels	Ease of paralleling outputs for higher (two times) current capability. This helps when driving parallel-power switches.
Expanded VDD operating range of 4.5 V to 26 V	Flexibility in system design. Covers a wide range of power switches
Expanded operating temperature range of -40°C to $+150^{\circ}\text{C}$	Flexibility in system design. System robustness improvement
VDD UVLO protection	Outputs are held low in UVLO condition, which ensures predictable, glitch-free operation at power-up and power-down.
Outputs are held low when input pins (INx) are in floating condition.	Protection feature, especially useful in passing abnormal condition tests during safety certification
Outputs are enabled when enable pins (ENx) are in floating condition.	Pin-to-pin compatibility with legacy devices from Texas Instruments in designs where Pin 1 and Pin 8 are "No Connect" pins
Input and enable threshold with wide hysteresis	Enhanced noise immunity while retaining compatibility with microcontroller logic-level input signals (3.3 V, 5 V) optimized for digital power
Inputs independent of VDD	System simplification, especially related to auxiliary bias supply architecture

7.2 Functional Block Diagram

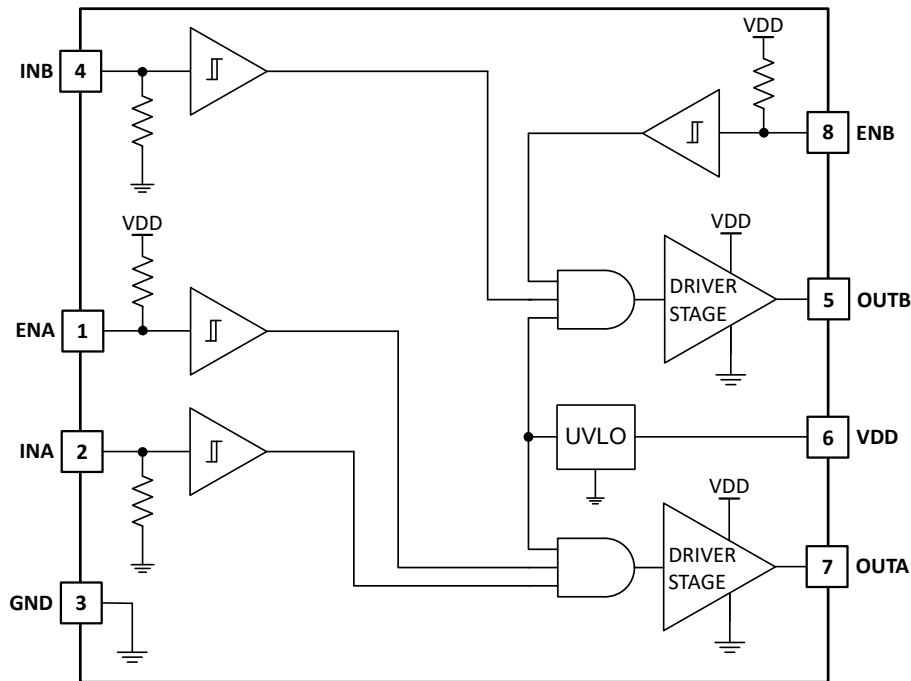

Typical ENx pullup resistance is 200 k Ω and INx pulldown resistance is 120 k Ω .

7.3 Feature Description

7.3.1 Operating Supply Current

The UCC27624-Q1 device features low quiescent I_{DD} currents. The typical operating supply current in UVLO state and fully-on state (under static and switching conditions) are summarized in the Electrical Characteristics table. The lowest quiescent current (I_{DD}) is achieved when the device is fully on and the outputs are in a static state (DC high or DC low). During this state, all of the internal logic circuits of the device are fully operational. The total supply current is the sum of the quiescent I_{DD} current, the average I_{OUT} current because of switching, and any current related to pullup resistors on the enable pins. Knowing the operating switching frequency (f_{SW}) and the MOSFET gate charge (Q_G) at the drive voltage being used, the average I_{OUT} current can be calculated as product of Q_G and f_{SW} .

[Typical Characteristics](#) provides a complete characterization of the I_{DD} current as a function of switching frequency at different V_{DD} bias voltages. The linear variation and close correlation with the theoretical value of the average I_{OUT} indicate a negligible shoot-through inside the gate driver device, displaying its high-speed characteristics.

7.3.2 Input Stage

The input pins of the UCC27624-Q1 gate driver device are based on a TTL compatible input threshold logic that is independent of the V_{DD} supply voltage. With a high threshold of 2 V and a low threshold of 1 V, the logic level thresholds are conveniently driven with PWM control signals derived from 3.3-V and 5-V digital power controller devices. Wider hysteresis (1-V typical) offers enhanced noise immunity compared to traditional TTL logic implementations, where the hysteresis is typically less than 0.5 V. UCC27624-Q1 devices also feature tight control of the input pin threshold voltage levels, which eases system design considerations and ensures stable operation across temperature (refer to [Typical Characteristics](#)). The very low input capacitance on these pins reduces loading and increases switching speed.

The UCC27624-Q1 device features an important protection feature that holds the output of a channel low when the respective input pin is in a floating condition. This is achieved through the internal pulldown resistors to ground on both of the input pins (INA, INB), as shown in .

The input pins can handle wide range of slew rate. In most power supply applications, the gate driver is either driven by the output of a digital controller or logic gates. Therefore, in most applications the input signal slew rate is fast and is no concern for the UCC27624 family of devices. The wide hysteresis offered in UCC27624-Q1 alleviates the concern of chattering compared to many other drivers that have very small hysteresis at the input. If limiting the rise or fall times to the power device is the primary goal, then an external gate resistor is highly recommended between the output of the driver and the gate of the switching power device. This external resistor has the additional benefit of reducing part of the gate-charge related power dissipation in the gate driver device package and transferring it into the external resistor itself. In short, some of the power gets dissipated in the gate resistor rather than inside of the gate driver. Additionally, the input pins of UCC27624-Q1 are capable of handling -10 V. This improves the system robustness in noisy (electrical) applications. This also enables the driver to directly connect to the output of a gate drive transformer without the use of rectifying diodes, which saves board space and BOM cost.

7.3.3 Enable Function

The enable function is an extremely beneficial feature in gate driver devices, especially for certain applications such as synchronous rectification where the driver outputs are disabled in light-load conditions to prevent negative current circulation and to improve light-load efficiency.

The UCC27624-Q1 device is equipped with independent enable pins (ENx) for exclusive control of each driver channel operation. The enable pins are based on a non-inverting configuration (active-high operation). Thus, when ENx pins are driven high, the drivers are enabled and when ENx pins are driven low, the driver outputs are disabled. Similar to the input pins, the enable pins are also based on a TTL compatible threshold logic that is independent of the supply voltage and are effectively controlled using logic signals from 3.3-V or 5-V controllers. The UCC27624-Q1 device also features tight control of the enable-function threshold-voltage levels which eases system design considerations and ensures stable operation across temperature. The ENx pins are internally pulled up to VDD using pullup resistors, as a result of which the outputs of the device are enabled in the default state. Hence even if the ENx pins are left floating the driver output is enabled. Essentially, this floating allows the UCC27624-Q1 device to be pin-to-pin compatible with TI's previous generation of drivers (UCC27324, UCC27424, UCC27524), where Pin 1 and Pin 8 are either ENx or N/C pins. If the channel A and channel B inputs and outputs are connected in parallel to increase the driver current capacity, ENA and ENB must be connected and driven together. The ENx pins of the UCC27624-Q1 are capable of handling -10 V, which improves system robustness in noisy (electrical) applications.

7.3.4 Output Stage

The UCC27624-Q1 device output stage features a unique architecture on the pullup structure, which delivers the highest peak source current when it is most needed, during the Miller plateau region of the power switch turn-on transition (when the power switch drain or collector voltage experiences dV/dt). The device output stage features a hybrid pullup structure using a parallel arrangement of N-Channel and P-Channel MOSFET devices. By turning on the N-Channel MOSFET during a narrow instant when the output changes state from low to high, the gate driver device is able to deliver a brief boost in the peak sourcing current enabling fast turn-on. The on-resistance of this N-channel MOSFET (R_{NMOS}) is approximately 1.04Ω when activated.

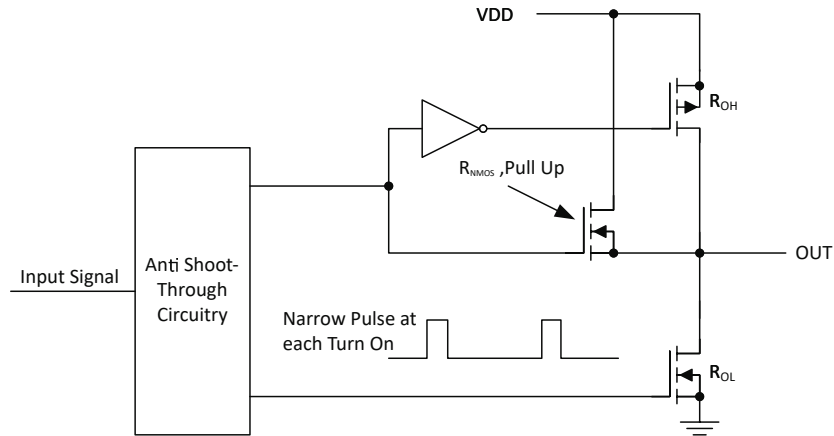

Figure 7-1. UCC27624-Q1 Gate Driver Output Structure

The R_{OH} parameter is a DC measurement and it is representative of the on-resistance of the P-Channel device only. This is because the N-Channel device is held in the off state in DC condition and is turned-on only for a narrow instant when output changes state from low to high. Note that effective resistance of the UCC27624-Q1 pull-up stage during the turn-on instance is much lower than what is represented by R_{OH} parameter.

The pull-down structure in the UCC27624-Q1 device is simply comprised of a N-Channel MOSFET. The R_{OL} parameter, which is also a DC measurement, is representative of the impedance of the pull-down stage in the device.

Each output stage in the UCC27624-Q1 device is capable of supplying 5-A peak source and 5-A peak sink current pulses. The output voltage swings between VDD and GND providing rail-to-rail operation, thanks to the MOS-output stage which delivers very low dropout. The presence of the MOSFET-body diodes also offers low impedance to transient overshoots and undershoots. The outputs of these drivers are designed to withstand 5A of peak reverse current transients without damage to the device.

The UCC27624-Q1 device is particularly suited for dual-polarity, symmetrical drive-gate transformer applications where the primary winding of transformer driven by OUTA and OUTB, with inputs INA and INB being driven complementary to each other. This is possible because of the extremely low dropout offered by the MOS output stage of these devices, both during high (V_{OH}) and low (V_{OL}) states along with the low impedance of the driver output stage. All of these allow alleviate concerns regarding transformer demagnetization and flux imbalance. The low propagation delays also ensure proper reset for high-frequency applications.

For applications that have zero voltage switching during power MOSFET turn-on or turn-off interval, the driver supplies high-peak current for fast switching even though the miller plateau is not present. This situation often occurs in synchronous rectifier applications because the body diode is generally conducting before power MOSFET is switched on.

7.3.5 Low Propagation Delays and Tightly Matched Outputs

The UCC27624-Q1 driver device features a very small, 17-ns (typical) propagation delay between input and output, which offers the lowest level of pulse width distortion for high-frequency switching applications. For example, in synchronous rectifier applications, the SR MOSFETs are driven with very low distortion when a single driver device is used to drive the SR MOSFETs. Additionally, the driver devices also feature extremely accurate, 1-ns (typical) matched internal propagation delays between the two channels, which is beneficial for applications that require dual gate drives with critical timing. For example, in a PFC application, a pair of paralleled MOSFETs can be driven independently using each output channel, with the inputs of both channels driven by a common control signal from the PFC controller. In this case, the 1-ns delay matching ensures that the paralleled MOSFETs are driven in a simultaneous fashion, minimizing turn-on and turn-off delay differences. Another benefit of the tight matching between the two channels is that the two channels can be connected together to effectively double the drive current capability. That is, A and B channels may be combined into a single driver by connecting the INA and INB inputs together and the OUTA and OUTB outputs together; then, a single signal controls the paralleled power devices.

7.4 Device Functional Modes

Table 7-2. Device Logic Table

ENA	ENB	INA	INB	UCC27624-Q1	
				OUTA	OUTB
H	H	L	L	L	L
			H	L	H
		H	L	H	L
			H	H	H
L	L	Any	Any	L	L
Any	Any	Float	Float	L	L
Float	Float	L	L	L	L
			H	L	H
		H	L	H	L
			H	H	H

8 Application and Implementation

Note

Information in the following applications sections is not part of the TI component specification, and TI does not warrant its accuracy or completeness. TI's customers are responsible for determining suitability of components for their purposes, as well as validating and testing their design implementation to confirm system functionality.

8.1 Application Information

High-current gate driver devices are required in switching power applications for a variety of reasons. In order to achieve fast switching of power devices and reduce associated switching-power losses, a powerful gate driver device is employed between the PWM output of control devices and the gates of the power semiconductor devices. Further, gate driver devices are indispensable when it is not feasible for the PWM controller device to directly drive the gates of the switching devices. With the advent of digital power, this situation is often encountered because the PWM signal from the digital controller is often a 3.3-V logic signal which is not capable of effectively turning ON a power switch. A level-shifting circuitry is required to boost the 3.3-V signal to the gate-drive voltage (such as 12 V) in order to fully turn ON the power device and minimize conduction losses. Traditional buffer-drive circuits based on NPN/PNP bipolar transistors in a totem-pole arrangement, as emitter-follower configurations, prove inadequate with digital power because the traditional buffer-drive circuits lack level-shifting capability. Gate driver devices effectively combine both the level-shifting and buffer-drive functions. Gate driver devices also find other needs, such as minimizing the effect of high frequency switching noise by locating the high-current driver physically close to the power switch, driving gate-drive transformers and controlling floating power device gates, reducing power dissipation and thermal stress in controller devices by moving gate-charge power losses into the controller.

Finally, emerging wide band-gap power device technologies, such as SiC MOSFETs and GaN switches, which are capable of supporting very high switching frequency operation, are driving special requirements in terms of gate-drive capability. These requirements include a wide operating voltage range (5 V to 26 V), low propagation delays, good delay matching, and availability in compact, low inductance packages with good thermal capability. In summary, gate driver devices are an extremely important component in switching power combining benefits of high performance, low cost, low component count, board space reduction, and simplified system design.

8.2 Typical Application

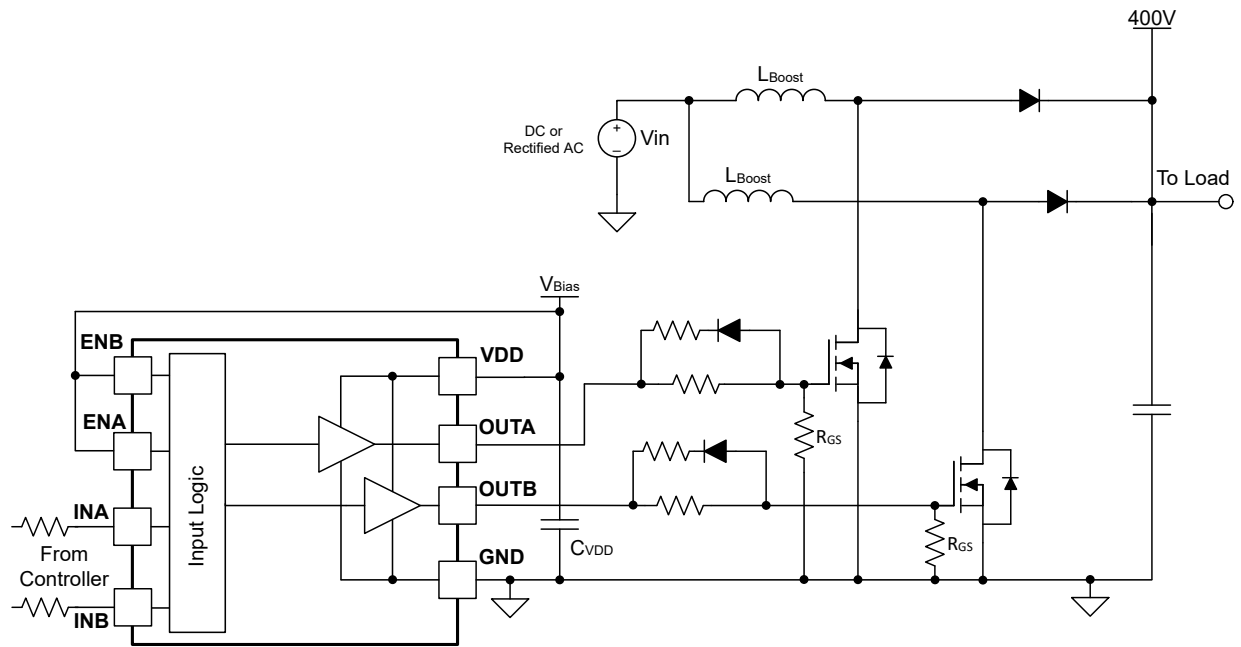

Figure 8-1. UCC27624-Q1 Typical Application Diagram

8.2.1 Design Requirements

When selecting and designing-in the gate driver device for an end application, some functional aspects must be considered and evaluated first, in order to make the most appropriate selection. Among these considerations are bias voltage, UVLO, drive current, and power dissipation.

8.2.2 Detailed Design Procedure

8.2.2.1 VDD and Undervoltage Lockout

The UCC27624-Q1 device has an internal undervoltage-lockout (UVLO) protection feature on the VDD pin supply circuit blocks. When VDD is rising and the level is still below UVLO threshold, this circuit holds the output low, regardless of the status of the inputs. The UVLO is typically 4 V with 300-mV typical hysteresis. This hysteresis prevents chatter when VDD supply voltages have noise, specifically at the lower end of the VDD operating range. UVLO hysteresis is also important to avoid any false tripping due to the bias noise generated because of fast switching transitions, where large peak currents are drawn from the bias supply bypass capacitors. The driver capability to operate at wide bias voltage range, along with good switching characteristics, is especially important in driving emerging power semiconductor devices, such as advanced low gate charge fast MOSFETs, GaN FETs, and SiC MOSFETs.

At power-up, the UCC27624-Q1 driver device output remains low until the VDD voltage reaches the UVLO rising threshold, irrespective of the state of any other input pins such as IN_x and EN_x. After the UVLO rising threshold, the magnitude of the OUT signal rises with V_{DD} until steady-state V_{DD} is reached.

For the best high-speed circuit performance and to prevent noise problems because the device draws current from the VDD pin to bias all internal circuits, use two VDD bypass capacitors. Also, use surface mount, low ESR capacitors. A 0.1- μ F ceramic capacitor should be located less than 1 mm from the VDD to GND pins of the gate-driver device. In addition, a larger capacitor ($\geq 1 \mu$ F) must be connected in parallel (also as close to the driver IC as possible) to help deliver the high-current peaks required by the load. The parallel combination of capacitors presents a low impedance characteristic for the expected current levels and switching frequencies in the application.

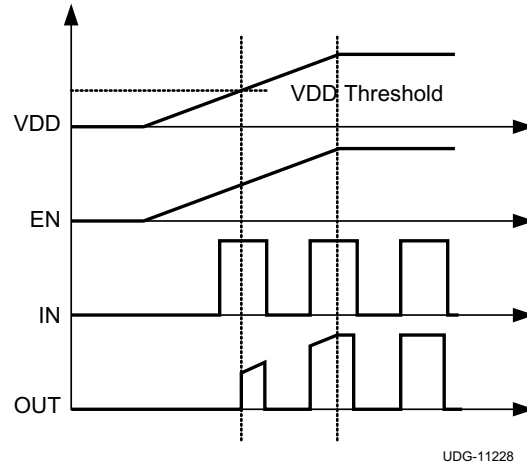

Figure 8-2. Power-Up Sequence

8.2.2.2 Drive Current and Power Dissipation

The UCC27624-Q1 driver is capable of delivering 5 A of peak current to a switching power device gate (MOSFET, IGBT, SiC MOSFET, GaN FET) for a period of several-hundred nanoseconds at $V_{DD} = 12$ V. High peak current is required to turn ON the device quickly. Then, to turn the device OFF, the driver is required to sink a similar amount of current to ground, which repeats at the operating switching frequency of the power device. The power dissipated in the gate driver device package depends on the following factors:

- Gate charge of the power MOSFET (usually a function of the drive voltage V_{GS} , which is very close to input bias supply voltage V_{DD} due to low V_{OH} drop-out).
- Switching frequency
- External gate resistors

Because UCC27624-Q1 features low-quiescent currents and internal logic to eliminate any shoot-through in the output driver stage, their effect on the power dissipation within the gate driver is very small compared to the losses due to switching of the power device.

When a driver device is tested with a discrete capacitive load, calculating the power that is required from the bias supply is fairly simple. The following equation provides an example of the energy that must transfer from the bias supply to charge the capacitor.

$$E_G = \frac{1}{2} C_{LOAD} V_{DD}^2 \quad (1)$$

where

- C_{LOAD} is the load capacitor.
- V_{DD} is the bias voltage of the driver.

There is an equal amount of energy dissipated when the capacitor is discharged. This leads to a total power loss, as shown in the following equation example.

$$P_G = C_{LOAD} V_{DD}^2 f_{SW} \quad (2)$$

where

- f_{SW} is the switching frequency.

With $V_{DD} = 12$ V, $C_{LOAD} = 10$ nF and $f_{SW} = 300$ kHz, the switching power loss is calculated as follows:

$$P_G = 10\text{nF} \times 12\text{V}^2 \times 300\text{kHz} = 0.432\text{W} \quad (3)$$

The switching load presented by a power MOSFET is converted to an equivalent capacitance by examining the gate charge required to switch the device. This gate charge includes the effects of the input capacitance plus the added charge needed to swing the drain voltage of the power device as it switches between the ON and OFF states. Most manufacturers provide specifications that provide the typical and maximum gate charge, in nC, to switch the device under specified conditions. Using the gate charge Q_g , the power that must dissipate when charging a capacitor is determined, which by using the equivalence $Q_g = C_{LOAD}V_{DD}$ is shown in the following equation.

$$P_G = C_{LOAD}V_{DD}^2f_{SW} = Q_gV_{DD}f_{SW} \quad (4)$$

Assuming that the UCC27624-Q1 device is driving power MOSFET with 60 nC of gate charge ($Q_g = 60$ nC at $V_{DD} = 12$ V) on each output, the gate charge related power loss is calculated using the equation below.

$$P_G = 2 \times 60 \text{ nC} \times 12 \text{ V} \times 300 \text{ kHz} = 0.432 \text{ W} \quad (5)$$

This power P_G is dissipated in the resistive elements of the circuit when the MOSFET turns on or turns off. Half of the total power is dissipated when the load capacitor is charged during turn-on, and the other half is dissipated when the load capacitor is discharged during turn-off. When no external gate resistor is employed between the driver and MOSFET/IGBT, this power is completely dissipated inside the driver package. With the use of external gate resistors, the power dissipation is shared between the internal resistance of driver and external gate resistor in accordance to the ratio of the resistances (more power dissipated in the higher resistance component). Based on this simplified analysis, the driver power dissipation during switching is calculated as follows:

$$P_{SW} = 0.5 \times Q_G \times V_{DD} \times f_{SW} \times \left(\frac{R_{OFF}}{R_{OFF} + R_{GATE}} + \frac{R_{ON}}{R_{ON} + R_{GATE}} \right) \quad (6)$$

where

- $R_{OFF} = R_{OL}$
- R_{ON} (effective resistance of pull-up structure)

The above equation is necessary when the external gate resistor is large enough to reduce the peak current of the driver. In addition to the above gate-charge related power dissipation, dissipation in the driver is related to the power associated with the quiescent bias current consumed by the device to bias all internal circuits such as input stage (with pullup and pulldown resistors), enable, and UVLO sections. As shown in the electrical characteristics table, the quiescent current is less than 1 mA. The power loss due to DC current consumption of the driver internal circuit can be calculated as below.

$$P_Q = I_{DD}V_{DD} \quad (7)$$

Assuming total internal current consumption to be 0.6 mA (typical) at bias voltage of 12 V, the DC power loss in the driver is:

$$P_Q = 0.6 \text{ mA} \times 12 \text{ V} = 7.2 \text{ mW} \quad (8)$$

This power loss is insignificant compared to gate charge related power dissipation calculated earlier.

With a 12-V supply, the bias current is estimated as follows, with an additional 0.6-mA overhead for the quiescent consumption:

$$I_{DD} \sim \frac{P_G}{V_{DD}} = \frac{0.432 \text{ W}}{12 \text{ V}} = 0.036 \text{ A} \quad (9)$$

If the gate driver is used with inductive load, then special attention should be paid to the ringing on each pin of the gate driver device. The ringing should not exceed the recommended operating rating of the pin.

8.2.3 Application Curves

The figures below show the typical switching characteristics of the UCC27624-Q1 device used in high-voltage boost converter application. In this application, the UCC27624-Q1 is driving the IGBT switch that has a gate charge of 110 nC.

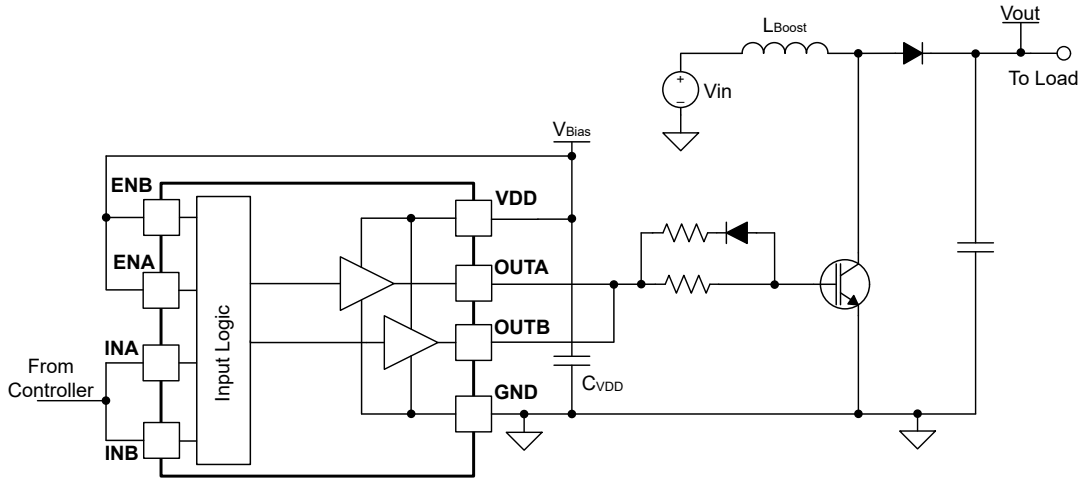
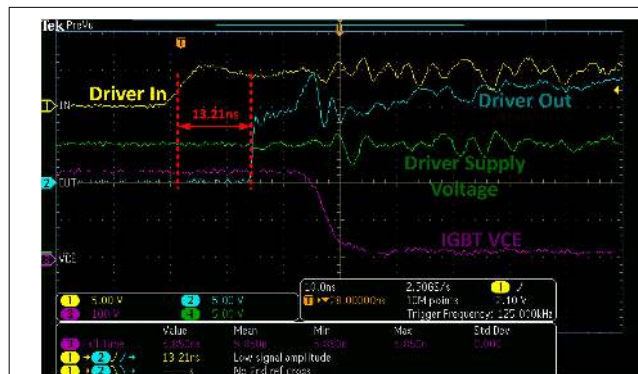
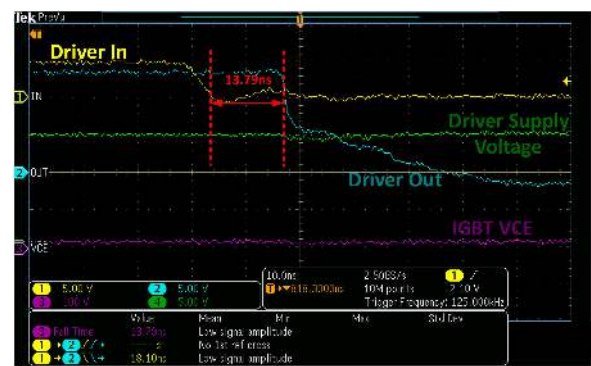

Figure 8-3. UCC27624-Q1 Used to Drive IGBT in the Boost Converter



$V_{in} = 210\text{ V}$, $V_{out} = 235\text{ V}$, $I_{out} = 1.14\text{ A}$, $F_{sw} = 125\text{ kHz}$,
driver supply voltage = 15 V, gate resistor = 0 Ω

Figure 8-4. Turn-On Propagation Delay Waveform



$V_{in} = 210\text{ V}$, $V_{out} = 235\text{ V}$, $I_{out} = 1.14\text{ A}$, $F_{sw} = 100\text{ kHz}$,
driver supply voltage = 15 V, gate resistor = 0 Ω

Figure 8-5. Turn-Off Propagation Delay Waveform

9 Power Supply Recommendations

The bias supply voltage range for the UCC27624-Q1 device is rated to operate is from 4.5 V to 26 V. The lower end of this range is governed by the internal undervoltage-lockout (UVLO) protection feature on the V_{DD} pin supply circuit blocks. If the driver is in a UVLO condition when the V_{DD} pin voltage is below the VDD UVLO turn-on (rising) threshold, the UVLO protection feature holds the output low, regardless of the status of the inputs. The upper end of this range is driven by the 30-V absolute maximum voltage rating of the VDD pin of the device (which is a stress rating). It is necessary to have sufficient margin from the absolute maximum rating of the device to realize full operating life of the device. Therefore, the upper limit of recommended voltage of the VDD pin is 26 V.

The UVLO protection feature also has a hysteresis function. This means, when the VDD pin bias voltage exceeds the rising threshold voltage, the device begins to operate normally. If the VDD bias voltage drops below the rising threshold while on, the device continues to deliver normal functionality unless the voltage drop exceeds the hysteresis specification of the falling threshold. Therefore, while operating at or near the 4.5-V, design engineer should ensure that the voltage ripple on the auxiliary power supply output is smaller than the hysteresis specification of the device. Otherwise, the device output may turn-off. During system shutdown, the device operation continues until the VDD pin voltage has dropped below the VDD turn-off (falling) threshold, which must be accounted for while evaluating system shutdown timing or sequencing requirements. At system startup, the device does not begin operation until the VDD pin voltage has exceeded VDD turn-on (rising) threshold.

The quiescent current consumed by the internal circuit blocks of the device is supplied through the VDD pin. Although this fact is well known, recognizing that the charge for source current pulses delivered by the OUTA/B pin is also supplied through the same VDD pin capacitor, is important. As a result, every time a current is sourced out of the output pins, a corresponding current pulse is delivered into the device through the VDD pin. Thus, ensure that the local bypass capacitors are provided between the VDD and GND pins and locate them as close to the device pins as possible for the purpose of decoupling. A low ESR, ceramic surface mount capacitor is required. TI recommends having two capacitors: a 0.1- μF ceramic surface-mount capacitor placed less than 1 mm from the VDD pin of the device and another larger ceramic capacitor ($\geq 1 \mu\text{F}$) must be connected in parallel.

UCC27624-Q1 is a high-current gate driver. If the gate driver is placed far from the switching power device, such as a MOSFET, then that could create a large inductive loop. A large inductive loop may cause excessive ringing on any and all pins of the gate driver. This may result in stress that exceeds device recommended ratings. Therefore, place the gate driver as close to the switching power device as possible. Also, use an external gate resistor to damp any ringing due to the high switching currents and board parasitic elements.

10 Layout

10.1 Layout Guidelines

Proper PCB layout is extremely important in a high-current fast-switching circuit to provide appropriate device operation and design robustness. The UCC27624-Q1 gate driver incorporates small propagation delays and powerful output stages capable of delivering large current peaks with very fast rise and fall times at the gate of power MOSFET to facilitate very quick voltage transitions. Very high di/dt causes unacceptable ringing if the trace lengths and impedances are not well controlled. The following circuit layout guidelines are recommended when designing with these high-speed drivers.

- Place the driver IC as close as possible to the power device in order to minimize the length of high-current traces between the driver IC output pins and the gate of the switching power device.
- Place the VDD bypass capacitors between VDD and GND as close as possible to the driver IC with minimal trace length to improve the noise filtering. These capacitors support high peak current being drawn from VDD pin, during turn-on of power MOSFET. The use of low inductance surface-mounted-device (SMD) components such as 50V rated X7R chip capacitors are highly recommended.
- The turn-on and turn-off current loop paths (driver device, power MOSFET and VDD bypass capacitor) must be minimized as much as possible in order to keep the stray inductance to a minimum. High di/dt is established in these loops at two instances, namely during turn-on and turn-off transients, which induces significant voltage transients on the output pin of the driver device and Gate of the power MOSFET.
- Wherever possible, parallel the source and return traces to take advantage of flux cancellation.
- Separate power traces and signal traces, such as output and input signals.
- To minimize switch node transients and ringing, adding some gate resistance and/or snubbers on the power devices may be necessary. These measures may also reduce EMI.
- Star-point grounding is a good way to minimize noise coupling from one current loop to another. The GND of the driver is connected to the other circuit nodes such as source of power MOSFET and ground of PWM controller at one, single point. The connected paths must be as short as possible to reduce inductance and be as wide as possible to reduce resistance.
- Use a ground plane to provide noise shielding. Fast rise and fall times at OUT pin of the driver IC may corrupt the input signals of the driver IC. The ground plane must not be a conduction path for any high current (power stage) loop. Instead the ground plane must be connected to the star-point with one single trace to establish the ground potential. In addition to noise shielding, the ground plane can help in power dissipation as well
- External gate resistor and parallel diode-resistor combination may come in handy when replacing any gate driver IC with UCC27624-Q1 device in existing or new designs, specifically if they do not have the same drive strength.

11 Device and Documentation Support

11.1 Third-Party Products Disclaimer

TI'S PUBLICATION OF INFORMATION REGARDING THIRD-PARTY PRODUCTS OR SERVICES DOES NOT CONSTITUTE AN ENDORSEMENT REGARDING THE SUITABILITY OF SUCH PRODUCTS OR SERVICES OR A WARRANTY, REPRESENTATION OR ENDORSEMENT OF SUCH PRODUCTS OR SERVICES, EITHER ALONE OR IN COMBINATION WITH ANY TI PRODUCT OR SERVICE.

11.2 Receiving Notification of Documentation Updates

To receive notification of documentation updates, navigate to the device product folder on ti.com. Click on *Subscribe to updates* to register and receive a weekly digest of any product information that has changed. For change details, review the revision history included in any revised document.

11.3 Support Resources

[TI E2E™ support forums](#) are an engineer's go-to source for fast, verified answers and design help — straight from the experts. Search existing answers or ask your own question to get the quick design help you need.

Linked content is provided "AS IS" by the respective contributors. They do not constitute TI specifications and do not necessarily reflect TI's views; see TI's [Terms of Use](#).

11.4 Trademarks

PowerPAD™ is a trademark of Texas Instruments.

TI E2E™ is a trademark of Texas Instruments.

All trademarks are the property of their respective owners.

11.5 Electrostatic Discharge Caution



This integrated circuit can be damaged by ESD. Texas Instruments recommends that all integrated circuits be handled with appropriate precautions. Failure to observe proper handling and installation procedures can cause damage.

ESD damage can range from subtle performance degradation to complete device failure. Precision integrated circuits may be more susceptible to damage because very small parametric changes could cause the device not to meet its published specifications.

11.6 Glossary

[TI Glossary](#) This glossary lists and explains terms, acronyms, and definitions.

12 Mechanical, Packaging, and Orderable Information

The following pages include mechanical, packaging, and orderable information. This information is the most current data available for the designated devices. This data is subject to change without notice and revision of this document. For browser-based versions of this data sheet, refer to the left-hand navigation.

PACKAGING INFORMATION

Orderable Device	Status (1)	Package Type	Package Drawing	Pins	Package Qty	Eco Plan (2)	Lead finish/ Ball material (6)	MSL Peak Temp (3)	Op Temp (°C)	Device Marking (4/5)	Samples
PUCC27624QDGNRQ1	ACTIVE	HVSSOP	DGN	8	2500	TBD	Call TI	Call TI	-40 to 150		Samples
PUCC27624QDRQ1	ACTIVE	SOIC	D	8	3000	TBD	Call TI	Call TI	-40 to 150		Samples
UCC27624QDGNRQ1	ACTIVE	HVSSOP	DGN	8	2500	RoHS & Green	NIPDAU	Level-1-260C-UNLIM	-40 to 150	624Q	Samples
UCC27624QDRQ1	ACTIVE	SOIC	D	8	3000	RoHS & Green	NIPDAU	Level-1-260C-UNLIM	-40 to 150	27624Q	Samples

(1) The marketing status values are defined as follows:

ACTIVE: Product device recommended for new designs.

LIFEBUY: TI has announced that the device will be discontinued, and a lifetime-buy period is in effect.

NRND: Not recommended for new designs. Device is in production to support existing customers, but TI does not recommend using this part in a new design.

PREVIEW: Device has been announced but is not in production. Samples may or may not be available.

OBSELETE: TI has discontinued the production of the device.

(2) **RoHS:** TI defines "RoHS" to mean semiconductor products that are compliant with the current EU RoHS requirements for all 10 RoHS substances, including the requirement that RoHS substance do not exceed 0.1% by weight in homogeneous materials. Where designed to be soldered at high temperatures, "RoHS" products are suitable for use in specified lead-free processes. TI may reference these types of products as "Pb-Free".

RoHS Exempt: TI defines "RoHS Exempt" to mean products that contain lead but are compliant with EU RoHS pursuant to a specific EU RoHS exemption.

Green: TI defines "Green" to mean the content of Chlorine (Cl) and Bromine (Br) based flame retardants meet JS709B low halogen requirements of <=1000ppm threshold. Antimony trioxide based flame retardants must also meet the <=1000ppm threshold requirement.

(3) MSL, Peak Temp. - The Moisture Sensitivity Level rating according to the JEDEC industry standard classifications, and peak solder temperature.

(4) There may be additional marking, which relates to the logo, the lot trace code information, or the environmental category on the device.

(5) Multiple Device Markings will be inside parentheses. Only one Device Marking contained in parentheses and separated by a "-" will appear on a device. If a line is indented then it is a continuation of the previous line and the two combined represent the entire Device Marking for that device.

(6) Lead finish/Ball material - Orderable Devices may have multiple material finish options. Finish options are separated by a vertical ruled line. Lead finish/Ball material values may wrap to two lines if the finish value exceeds the maximum column width.

Important Information and Disclaimer:The information provided on this page represents TI's knowledge and belief as of the date that it is provided. TI bases its knowledge and belief on information provided by third parties, and makes no representation or warranty as to the accuracy of such information. Efforts are underway to better integrate information from third parties. TI has taken and

continues to take reasonable steps to provide representative and accurate information but may not have conducted destructive testing or chemical analysis on incoming materials and chemicals. TI and TI suppliers consider certain information to be proprietary, and thus CAS numbers and other limited information may not be available for release.

In no event shall TI's liability arising out of such information exceed the total purchase price of the TI part(s) at issue in this document sold by TI to Customer on an annual basis.

OTHER QUALIFIED VERSIONS OF UCC27624-Q1 :

- Catalog : [UCC27624](#)

NOTE: Qualified Version Definitions:

- Catalog - TI's standard catalog product

GENERIC PACKAGE VIEW

DGN 8

PowerPAD VSSOP - 1.1 mm max height

3 x 3, 0.65 mm pitch

SMALL OUTLINE PACKAGE

This image is a representation of the package family, actual package may vary.
Refer to the product data sheet for package details.

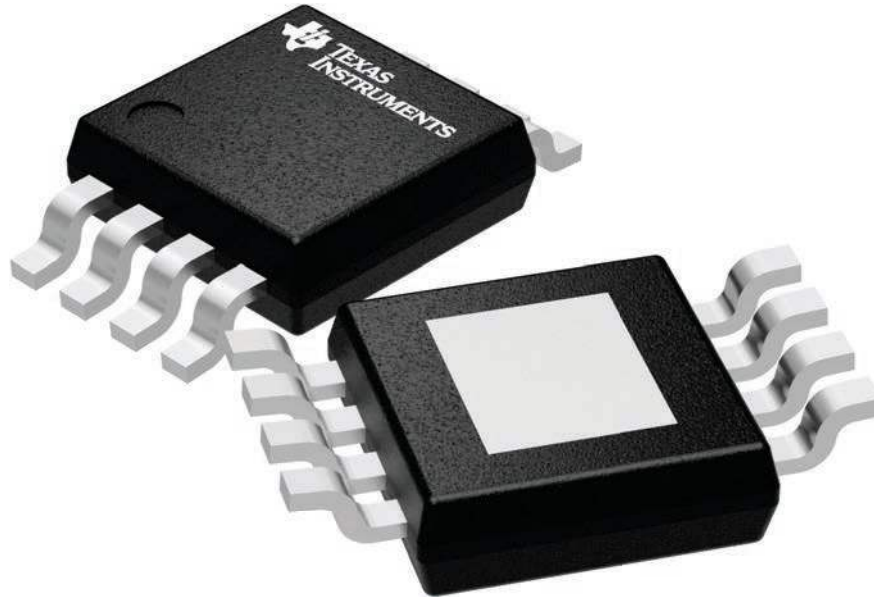

4225482/A

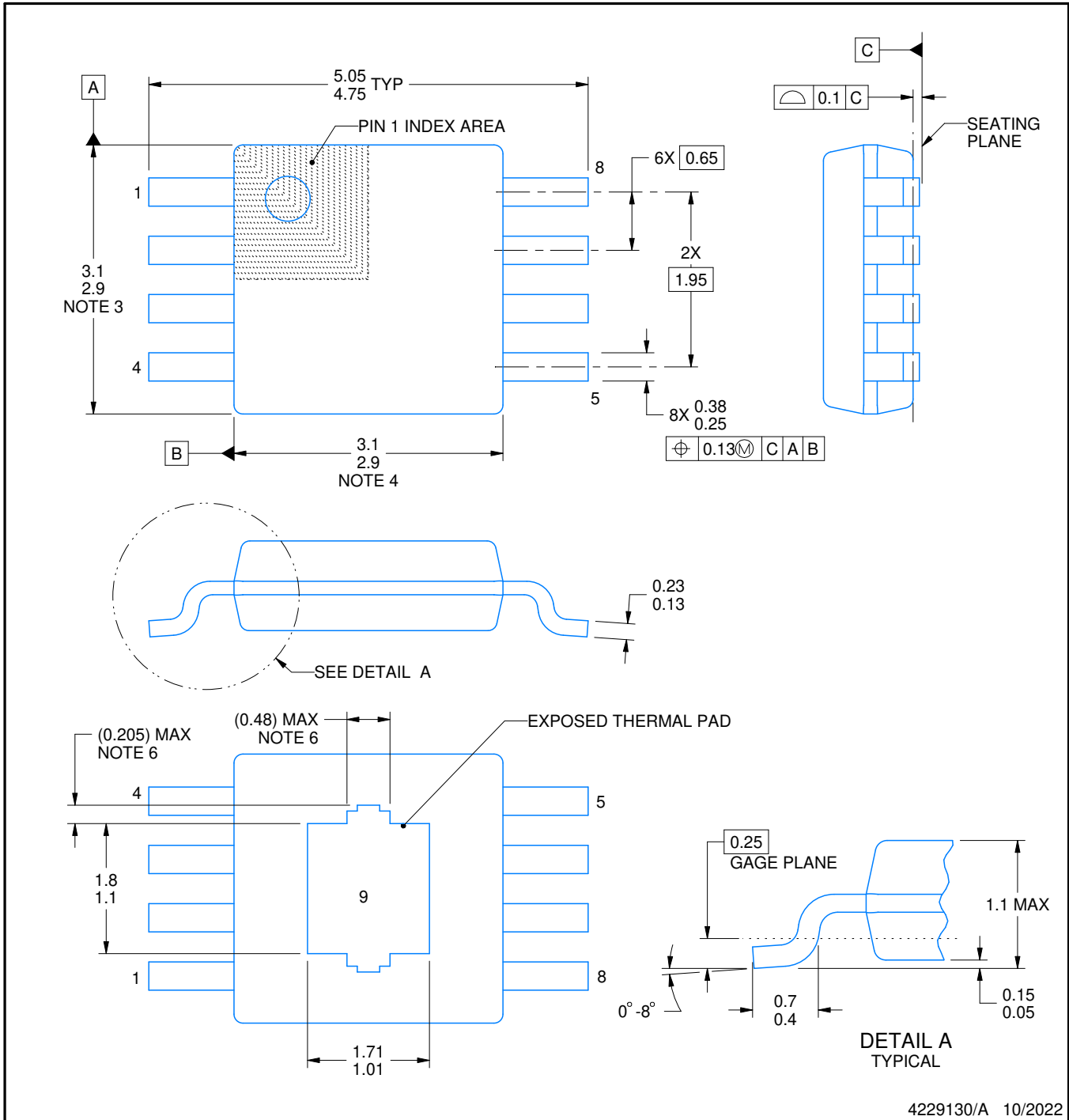
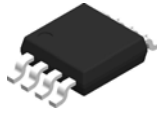

4229130/A 10/2022

NOTES:

PowerPAD is a trademark of Texas Instruments.

1. All linear dimensions are in millimeters. Any dimensions in parenthesis are for reference only. Dimensioning and tolerancing per ASME Y14.5M.
2. This drawing is subject to change without notice.
3. This dimension does not include mold flash, protrusions, or gate burrs. Mold flash, protrusions, or gate burrs shall not exceed 0.15 mm per side.
4. This dimension does not include interlead flash. Interlead flash shall not exceed 0.25 mm per side.
5. Reference JEDEC registration MO-187.
6. Features may differ or may not be present.

EXAMPLE BOARD LAYOUT

DGN0008H

PowerPAD™ VSSOP - 1.1 mm max height

SMALL OUTLINE PACKAGE

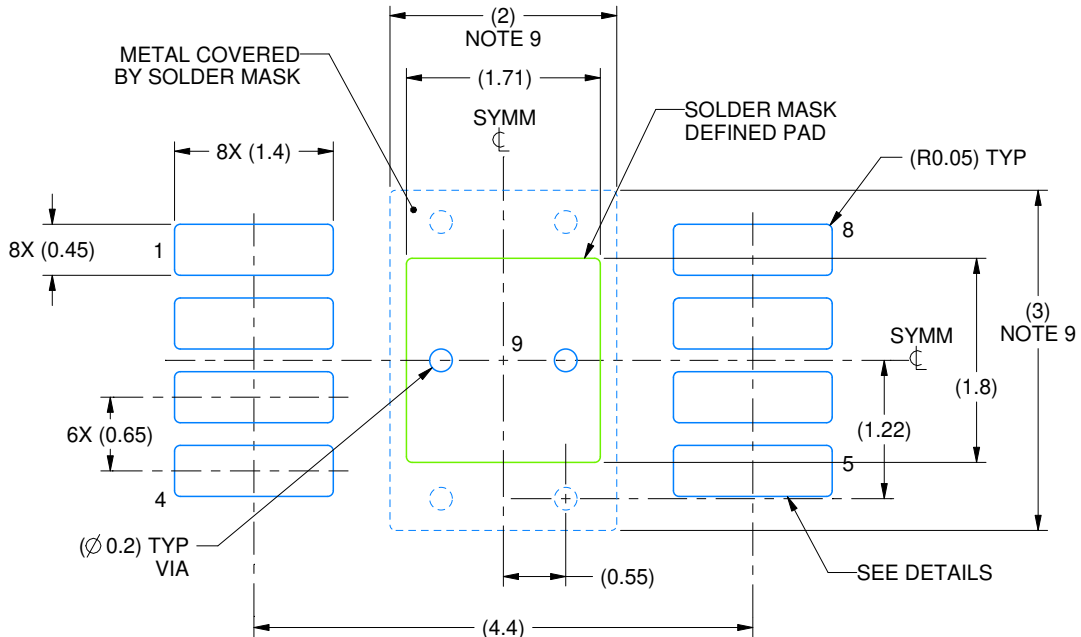

LAND PATTERN EXAMPLE
EXPOSED METAL SHOWN
SCALE: 15X

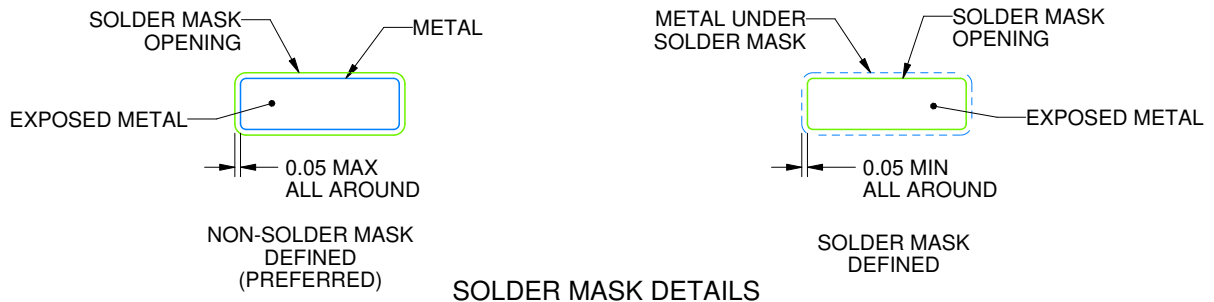

4229130/A 10/2022

NOTES: (continued)

7. Publication IPC-7351 may have alternate designs.
8. Solder mask tolerances between and around signal pads can vary based on board fabrication site.
9. Vias are optional depending on application, refer to device data sheet. If any vias are implemented, refer to their locations shown on this view. It is recommended that vias under paste be filled, plugged or tented.
10. Size of metal pad may vary due to creepage requirement.

EXAMPLE STENCIL DESIGN

DGN0008H

PowerPAD™ VSSOP - 1.1 mm max height

SMALL OUTLINE PACKAGE

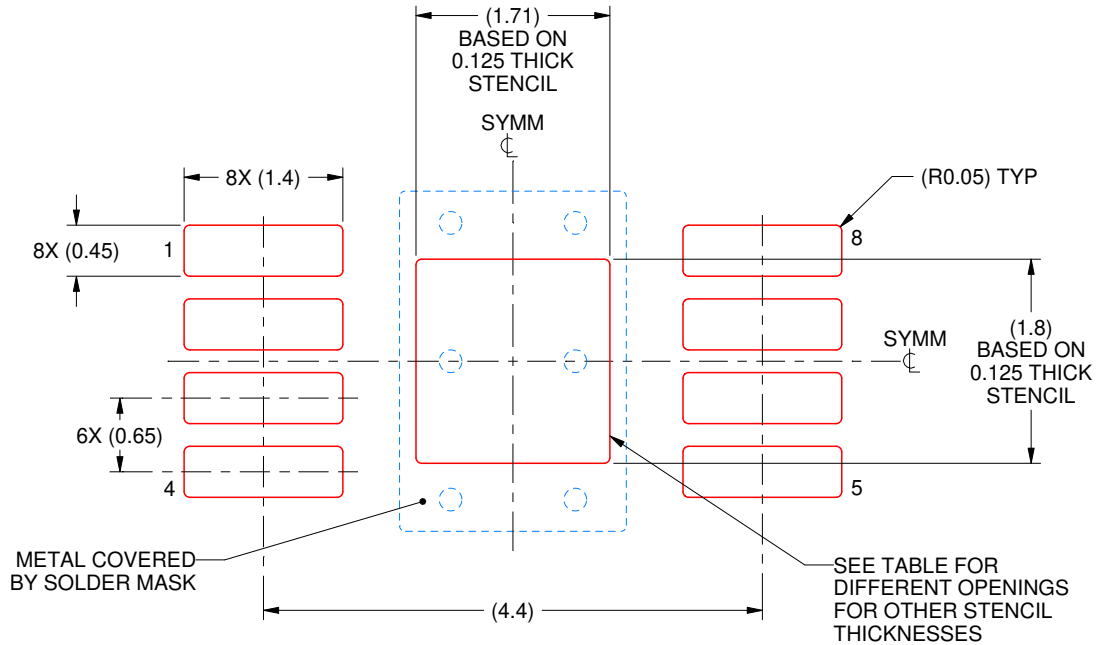

SOLDER PASTE EXAMPLE
EXPOSED PAD 9:
100% PRINTED SOLDER COVERAGE BY AREA
SCALE: 15X

STENCIL THICKNESS	SOLDER STENCIL OPENING
0.1	1.91 X 2.01
0.125	1.71 X 1.80 (SHOWN)
0.15	1.56 X 1.64
0.175	1.45 X 1.52

4229130/A 10/2022

NOTES: (continued)

11. Laser cutting apertures with trapezoidal walls and rounded corners may offer better paste release. IPC-7525 may have alternate design recommendations.
12. Board assembly site may have different recommendations for stencil design.



D0008A

PACKAGE OUTLINE

SOIC - 1.75 mm max height

SMALL OUTLINE INTEGRATED CIRCUIT



4214825/C 02/2019

NOTES:

- Linear dimensions are in inches [millimeters]. Dimensions in parenthesis are for reference only. Controlling dimensions are in inches. Dimensioning and tolerancing per ASME Y14.5M.
- This drawing is subject to change without notice.
- This dimension does not include mold flash, protrusions, or gate burrs. Mold flash, protrusions, or gate burrs shall not exceed .006 [0.15] per side.
- This dimension does not include interlead flash.
- Reference JEDEC registration MS-012, variation AA.

EXAMPLE BOARD LAYOUT

D0008A

SOIC - 1.75 mm max height

SMALL OUTLINE INTEGRATED CIRCUIT



LAND PATTERN EXAMPLE
EXPOSED METAL SHOWN
SCALE:8X



SOLDER MASK DETAILS

4214825/C 02/2019

NOTES: (continued)

- 6. Publication IPC-7351 may have alternate designs.
- 7. Solder mask tolerances between and around signal pads can vary based on board fabrication site.

EXAMPLE STENCIL DESIGN

D0008A

SOIC - 1.75 mm max height

SMALL OUTLINE INTEGRATED CIRCUIT



SOLDER PASTE EXAMPLE
BASED ON .005 INCH [0.125 MM] THICK STENCIL
SCALE:8X

4214825/C 02/2019

NOTES: (continued)

8. Laser cutting apertures with trapezoidal walls and rounded corners may offer better paste release. IPC-7525 may have alternate design recommendations.
9. Board assembly site may have different recommendations for stencil design.

IMPORTANT NOTICE AND DISCLAIMER

TI PROVIDES TECHNICAL AND RELIABILITY DATA (INCLUDING DATA SHEETS), DESIGN RESOURCES (INCLUDING REFERENCE DESIGNS), APPLICATION OR OTHER DESIGN ADVICE, WEB TOOLS, SAFETY INFORMATION, AND OTHER RESOURCES "AS IS" AND WITH ALL FAULTS, AND DISCLAIMS ALL WARRANTIES, EXPRESS AND IMPLIED, INCLUDING WITHOUT LIMITATION ANY IMPLIED WARRANTIES OF MERCHANTABILITY, FITNESS FOR A PARTICULAR PURPOSE OR NON-INFRINGEMENT OF THIRD PARTY INTELLECTUAL PROPERTY RIGHTS.

These resources are intended for skilled developers designing with TI products. You are solely responsible for (1) selecting the appropriate TI products for your application, (2) designing, validating and testing your application, and (3) ensuring your application meets applicable standards, and any other safety, security, regulatory or other requirements.

These resources are subject to change without notice. TI grants you permission to use these resources only for development of an application that uses the TI products described in the resource. Other reproduction and display of these resources is prohibited. No license is granted to any other TI intellectual property right or to any third party intellectual property right. TI disclaims responsibility for, and you will fully indemnify TI and its representatives against, any claims, damages, costs, losses, and liabilities arising out of your use of these resources.

TI's products are provided subject to [TI's Terms of Sale](#) or other applicable terms available either on [ti.com](https://www.ti.com) or provided in conjunction with such TI products. TI's provision of these resources does not expand or otherwise alter TI's applicable warranties or warranty disclaimers for TI products.

TI objects to and rejects any additional or different terms you may have proposed.

Mailing Address: Texas Instruments, Post Office Box 655303, Dallas, Texas 75265
Copyright © 2023, Texas Instruments Incorporated