

National Semiconductor is now part of
Texas Instruments.

Search <http://www.ti.com/> for the latest technical
information and details on our current products and services.

DS96172/DS96174 RS-485/RS-422 Quad Differential Line Drivers

General Description

The DS96172 and DS96174 are high speed quad differential line drivers designed to meet EIA Standard RS-485. The devices have TRI-STATE® outputs and are optimized for balanced multipoint data bus transmission at rates up to 10 Mbps. The drivers have wide positive and negative common mode range for multipoint applications in noisy environments. Positive and negative current-limiting is provided which protects the drivers from line fault conditions over a +12V to -7.0V common mode range. A thermal shutdown feature is also provided and occurs at junction temperature of approximately 160°C. The DS96172 features an active high and active low Enable, common to all four drivers. The DS96174 features separate active high Enables for each driver pair. Compatible RS-485 receivers, transceivers, and repeaters are also offered to provide optimum bus performance. The respective device types are DS96173, DS96175, DS96176 AND DS96177.

Features

- Meets EIA Standard RS-485 and RS-422A
- Monotonic differential output switching
- Transmission rate to 10 Mbs
- TRI-STATE outputs
- Designed for multipoint bus transmission
- Common mode output voltage range: -7V to +12V
- Operates from single +5V supply
- Thermal shutdown protection
- DS96172/DS96174 are lead and function compatible with the SN75172/75174 or the AM26LS31/MC3487 respectively

4

Connection Diagrams

16-Lead DIP
DS96172

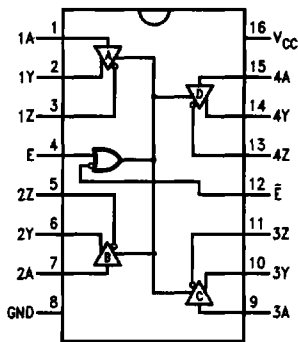

Top View

TL/F/9626-1

16-Lead DIP
DS96174

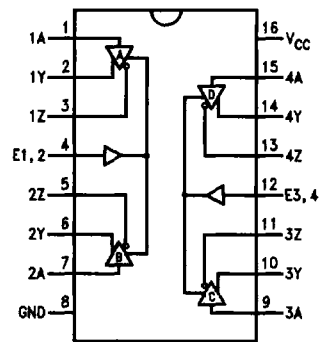

Top View

TL/F/9626-2

Order Number DS96172CJ or DS96174CJ

See NS Package Number J16A

Order Number DS96172CN or DS96174CN

See NS Package Number N16A

Absolute Maximum Ratings (Note 1)

If Military/Aerospace specified devices are required, please contact the National Semiconductor Sales Office/Distributors for availability and specifications.

Storage Temperature Range	
Ceramic DIP	-65°C to +175°C
Molded DIP	-65°C to +150°C
Operating Temperature Range	0°C to +70°C
Lead Temperature	
Ceramic DIP (soldering, 60 sec.)	300°C
Molded DIP (soldering, 10 sec.)	265°C
Supply Voltage	7V
Enable Input Voltage	5.5V
Maximum Power Dissipation*	25°C
J-Cavity Package	1.74W
N-Molded Package	1.98W

*Derate cavity package 14 mW/°C above 25°C; derate molded DIP package 16 mW/°C above 25°C.

Recommended Operating Conditions

	Min	Typ	Max	Units
Supply Voltage (V_{CC})	4.75	5	5.25	V
Common Mode Output Voltage (V_{OC})	-7		+12	V
Output Current HIGH (I_{OH})			-60	mA
Output Current LOW (I_{OL})			60	mA
Operating Temperature (T_A)	0	25	70	°C

Electrical Characteristics

over recommended temperature and supply voltage ranges, unless otherwise specified (Notes 2 and 3)

Symbol	Parameter	Conditions	Min	Typ	Max	Units
V_{IH}	Input Voltage HIGH		2			V
V_{IL}	Input Voltage LOW				0.8	V
V_{OH}	Output Voltage HIGH	$I_{OH} = -20$ mA		3.1		V
V_{OL}	Output Voltage LOW	$I_{OL} = 20$ mA		0.8		V
V_{IC}	Input Clamp Voltage	$I_I = -18$ mA			-1.5	V
$ V_{OD1} $	Differential Output Voltage	$I_O = 0$ mA			6	V
$ V_{OD2} $	Differential Output Voltage	$R_L = 54\Omega$, Figure 1	1.5	2		V
		$R_L = 100\Omega$, Figure 1	2	2.3		V
$\Delta V_{OD} $	Change in Magnitude of Differential Output Voltage (Note 4)	$R_L = 54\Omega$ or 100Ω , Figure 1			± 0.2	V
V_{OC}	Common Mode Output Voltage (Note 5)	$R_L = 54\Omega$, Figure 1			3	V
$\Delta V_{OC} $	Change in Magnitude of Common Mode Output Voltage (Note 4)				± 0.2	V
I_O	Output Current with Power Off	$V_{CC} = 0V$, $V_O = -7.0V$ to $12V$			± 100	μA
I_{OZ}	High Impedance State Output Current	$V_O = -7.0V$ to $12V$		± 50	± 200	μA
I_{IH}	Input Current HIGH	$V_I = 2.7V$			20	μA
I_{IL}	Input Current LOW	$V_I = 0.5V$			-100	μA
I_{OS}	Short Circuit Output Current (Note 6)	$V_O = -7.0V$			-250	mA
		$V_O = 0V$			-150	
		$V_O = V_{CC}$			150	
		$V_O = 12V$			250	
I_{CC}	Supply Current (All Drivers)	No Load	Outputs Enabled	50	70	mA
			Output Disabled	50	60	

Switching Characteristics $V_{CC} = 5V, T_A = 25^\circ C$

Symbol	Parameter	Conditions	Min	Typ	Max	Units
t_{DD}	Differential Output Delay Time	$R_L = 60\Omega$, Figure 2		15	25	ns
t_{TD}	Differential Output Transition Time			15	25	ns
t_{PLH}	Propagation Delay Time, Low-to-High Level Output	$R_L = 27\Omega$, Figure 3		12	20	ns
t_{PHL}	Propagation Delay Time, High-to-Low Level Output			12	20	ns
t_{PZH}	Output Enable Time to High Level	$R_L = 110\Omega$, Figure 4		30	45	ns
t_{PZL}	Output Enable Time to Low Level	$R_L = 110\Omega$, Figure 5		30	45	ns
t_{PHZ}	Output Disable Time from High Level	$R_L = 110\Omega$, Figure 4		25	35	ns
t_{PLZ}	Output Disable Time from Low Level	$R_L = 110\Omega$, Figure 5		30	45	ns

Note 1: "Absolute Maximum Ratings" are those values beyond which the safety of the device cannot be guaranteed. They are not meant to imply that the devices should be operated at these limits. The tables of "Electrical Characteristics" provide conditions for actual device operation.

Note 2: Unless otherwise specified min/max limits apply across the $0^\circ C$ to $+70^\circ C$ range for the DS96172/DS96174. All typicals are given for $V_{CC} = 5V$ and $T_A = 25^\circ C$.

Note 3: All currents into the device pins are positive; all currents out of the device pins are negative. All voltages are referenced to ground unless otherwise specified.

Note 4: $\Delta|V_{OD}|$ and $\Delta|V_{OC}|$ are the changes in magnitude of V_{OD} and V_{OC} respectively, that occur when the input is changed from a high level to a low level.

Note 5: In EIA Standards RS-422A and RS-485, V_{OC} , which is the average of the two output voltages with respect to ground, is called output offset voltage, V_{OS} .

Note 8: Only one output at a time should be shorted.

Parameter Measurement Information

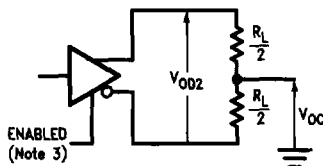

TL/F/9626-4

FIGURE 1. Differential and Common Mode Output Voltage

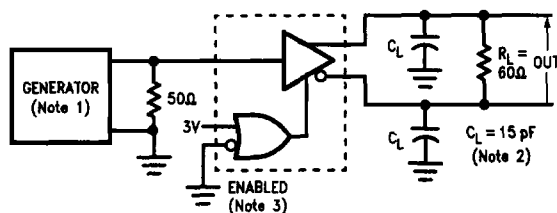

TL/F/9626-5

FIGURE 2. Differential Output Delay and Transition Times

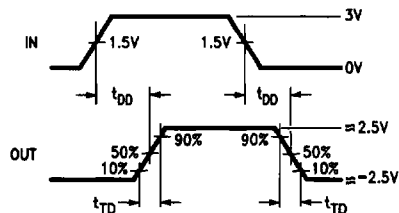

TL/F/9626-6

Parameter Measurement Information (Continued)

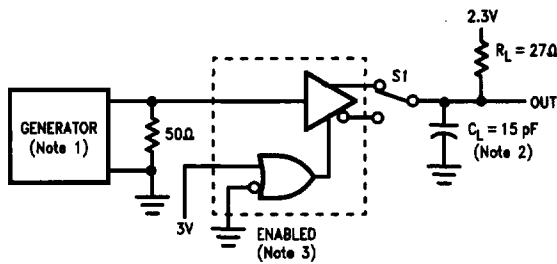

TL/F/9626-7

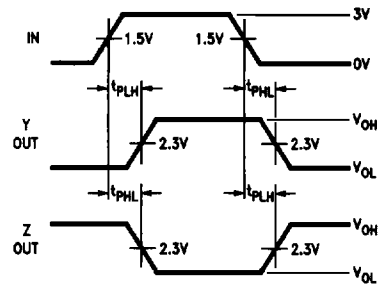

TL/F/9626-8

FIGURE 3. Propagation Delay Times

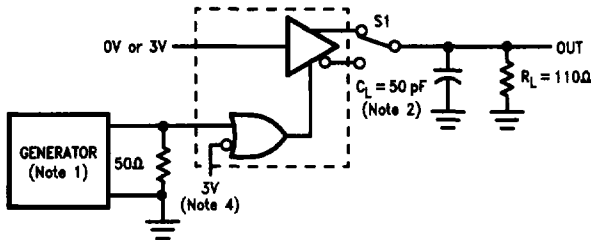

TL/F/9626-9

FIGURE 4. t_{pZH} and t_{pHZ}

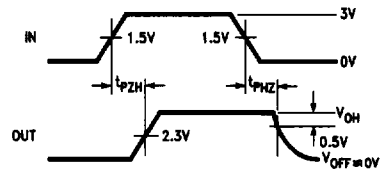

TL/F/9626-10

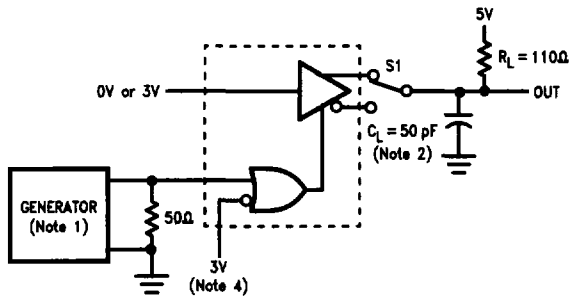

TL/F/9626-11

FIGURE 5. t_{pZL} and t_{pLZ}

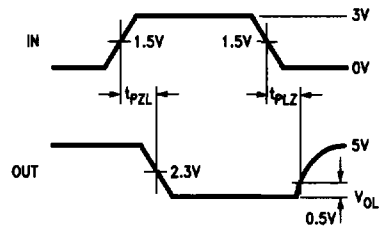

TL/F/9626-12

Note 1: The input pulse is supplied by a generator having the following characteristics: PRR = 1.0 MHz, duty cycle = 50%, $t_r \leq 5.0$ ns, $t_f \leq 5.0$ ns, $Z_0 = 50\Omega$.

Note 2: C_L includes probe and jig capacitance.

Note 3: DS96172 with active high and active low Enables is shown here. DS96174 has active high Enable only.

Note 4: To test the active low Enable \bar{E} of DS96172, ground E and apply an inverted waveform to \bar{E} . DS96174 has active high Enable only.

Function Tables

DS96172

Input A	Enables		Outputs	
	E	\bar{E}	Y	Z
H	H	X	H	L
L	H	X	L	H
H	X	L	H	L
L	X	L	L	H
X	L	H	Z	Z

DS96174

Input	Enable	Outputs	
		Y	Z
H	H	H	L
L	H	L	H
X	L	Z	Z

H = High Level
L = Low Level

X = Immaterial
Z = High Impedance (off)

Typical Application

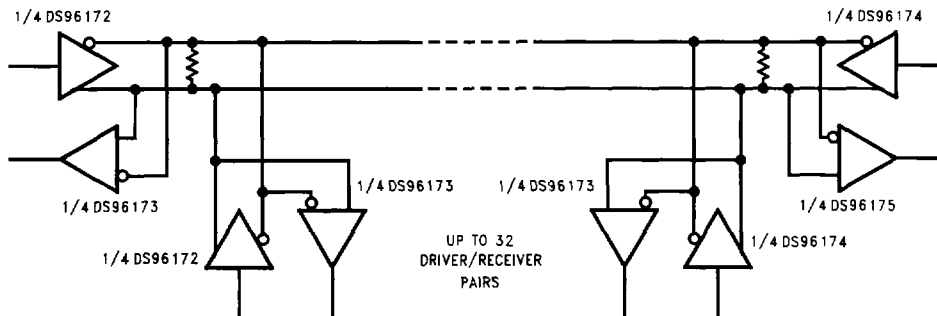

FIGURE 6

TL/F/9626-13

Note: The line length should be terminated at both ends in its characteristic impedance. Stub lengths off the main line should be kept as short as possible.