

REVISIONS

P	LTR	DESCRIPTION	DATE	DWN	APVD
	F1	REVISED PER ECR-15-008953	16JUN2015	NK	DC

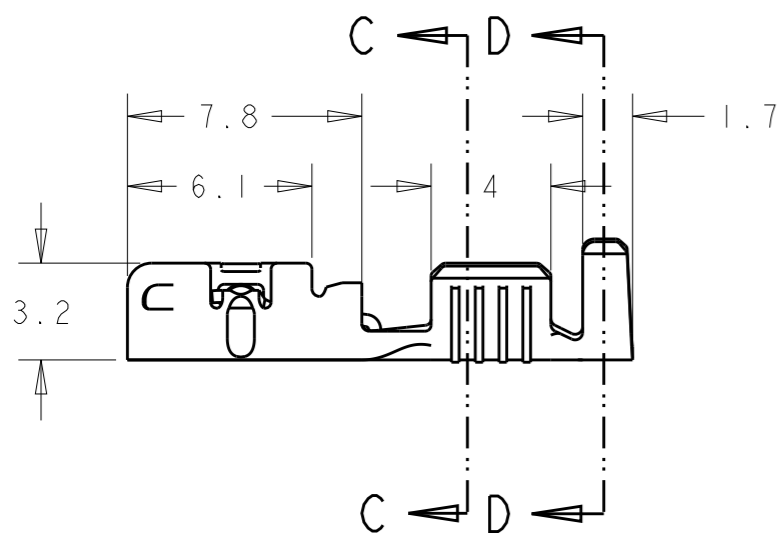

Para lengüeta de 0.8 mm
For 0.8mm tab thickness

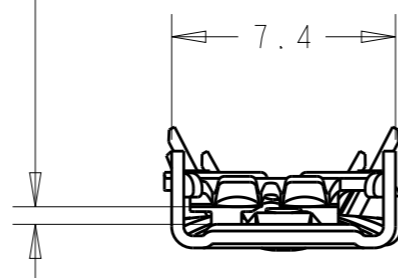

PACKAGING DETAILS:
QUANTITY PER REEL: 8000 PCS (END FEED)

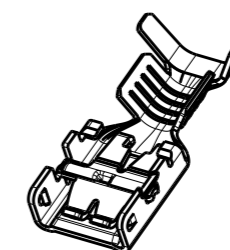

Left-sided product

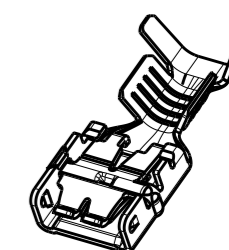

Right-sided product

Rango de hilo de >1,0 a 2,5 mm²
Wire range from >1.0 to 2.5 mm²
Diametro de aislante max 3,6 mm
Max. Insulation Diameter 3.6 mm

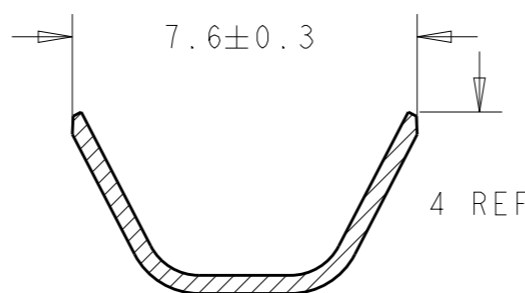
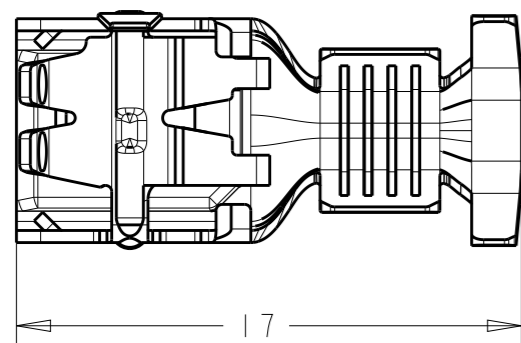

SECTION D-D
SCALE 6:1

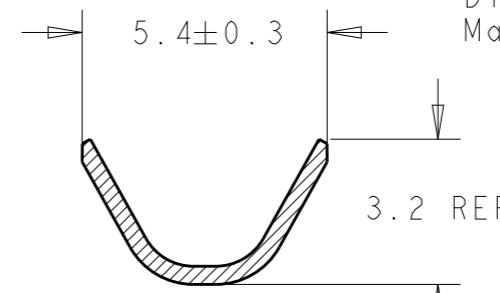

SECTION C-C
SCALE 6:1

336076-5	Acero Steel	Preniquelado Pre-Ni
336076-3	Latón Brass	Preestañado Pre-Tin
336076-1	Latón Brass	-
Guion Dash	Material	Acabado Finish

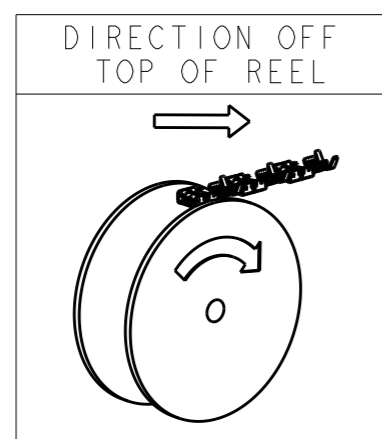

THIS DRAWING IS A CONTROLLED DOCUMENT.

DIMENSIONS:
mm

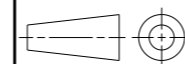

TOLERANCES UNLESS OTHERWISE SPECIFIED:

0 PLC	±0.5
1 PLC	±0.5
2 PLC	±
3 PLC	±
4 PLC	±
ANGLES	±

MATERIAL
Table

FINISH
Table

DWN J. Sal 22 Dec 04

CHK J. L 22 Dec 04

APVD -

PRODUCT SPEC
108-22128 Brass
108-22150 Pre-Ni Steel

APPLICATION SPEC
114-22017

WEIGHT -

Customer Drawing



NAME
E-SPRING CONTACT 6,35 Recept
6.35 Receptacle E-SPRING CONTACT

SIZE CAGE CODE DRAWING NO RESTRICTED TO

A300779 C-336076

SCALE 4:1 SHEET 1 OF 1 REV F1