



LED-39WPR Series– Programmable LED Driver

Dimmable Constant Current Driver

Set maximum current by Rset resistor, no computer needed

Metal Housing

Electrical Specifications

Input Voltage Range:	120-277 Vac Nom. (108-305 V Min/Max)
Frequency:	50/60 Hz Nom. (47-63 Hz Min/Max)
Power Factor:	>0.90 @ full load, 100V through 277V
Inrush Current:	40.0 Amps max @ 230 Vac
Input Current:	0.40 Amps max
Maximum Power:	39.2W
No-load Output Voltage:	60V
Load Regulation:	
THD:	≤ 20% @ full load
Peak Current:	20% during start-up
Ripple Current:	5%
Start-up Time:	500mS typical
Output Protection:	Over-Voltage, Short Circuit Protection with Auto Restart

Environmental Specifications

Maximum Case Temp.	81°C
Minimum Starting Temp:	-40°C
Storage Temperature:	-40°C to +85°C
Humidity:	10% to 90%
Cooling:	Convection
Vibration Frequency:	5 to 55 Hz/2g, 30 minutes
Sound Rating:	Class A
Lifetime:	100,000 Hours @ 60°C Tc, 50,000 Hours @ 70°C Tc
EMC:	FCC 47CFR Part 15 Class A compliant



- Total Power: 39 Watts
- Input Voltage: 120-277 Vac
- Adjustable Output Current: 190-700mA
- UL Dry & Damp Location Rated
- High Power Factor

Constant Current - Product Specifications

Model Number	Output Current Range (Select Level)	Output Voltage Range (Vdc)	Max Output Power (W)	Typical Efficiency
LED39WPR-056-C0700-BD	190-700	20-56	39.2	85%

Class 2: US/Canada

-BD indicates bottom leads and 0-10V Dimming. See page 4.



Bottom View



Note:
 LED drivers are designed and intended to operate LED loads only. Non-LED loading may be outside the specified design limits of our LED drivers, and therefore cannot be covered by any warranty. If you desire to use our LED drivers to operate non-LED loads please contact us to discuss compatibility.

Specifications subject to change without notice.

Rev 10-13-16



Dimensions - Inches (mm)

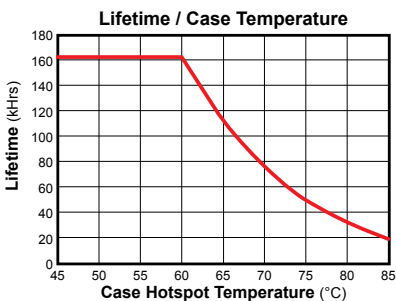
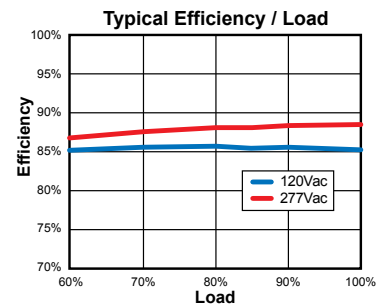
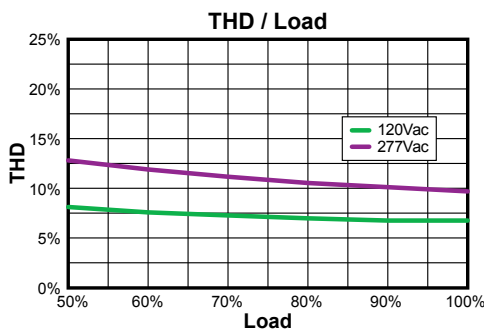
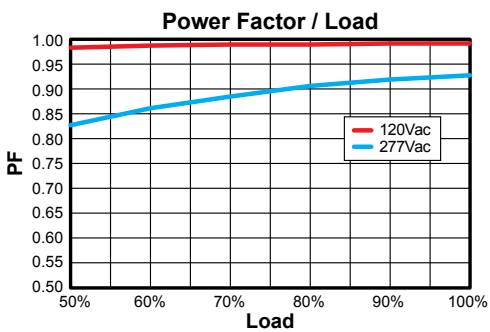
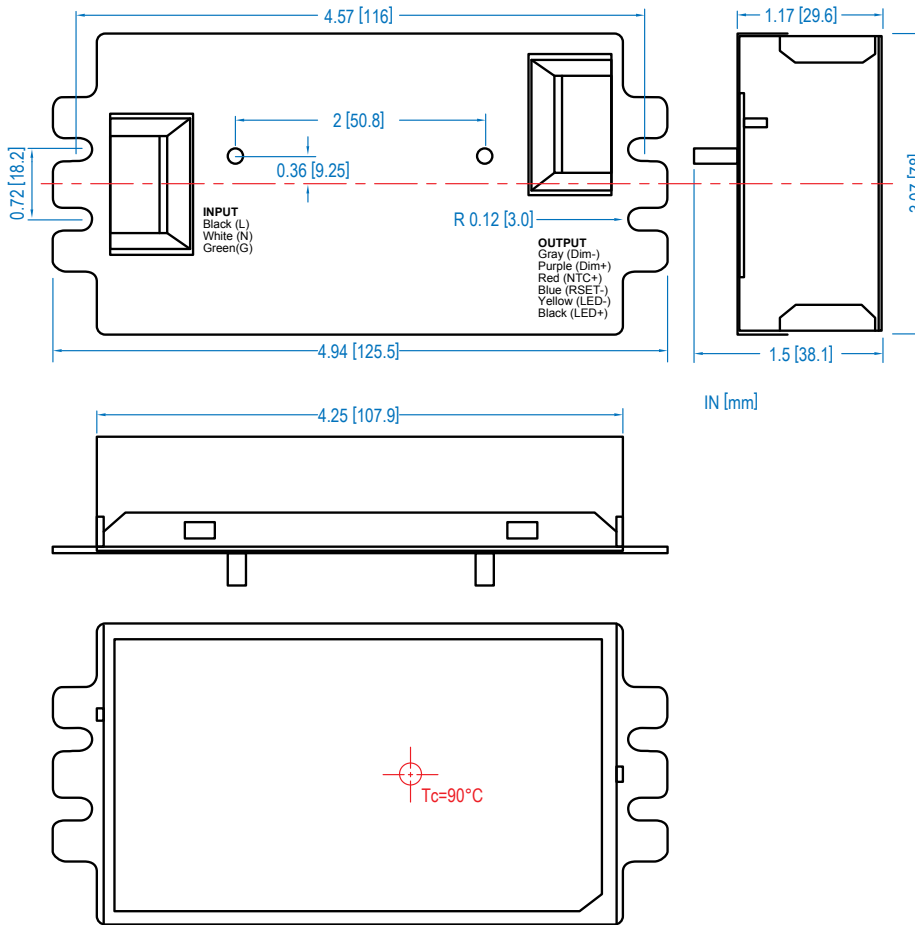

Safety Cert.	Standard
UL/CUL	UL8750
EMC Standard	Notes
FCC, 47CFR Part 15	Class A
IEC61000-4-5	Performance criterion C

Wiring

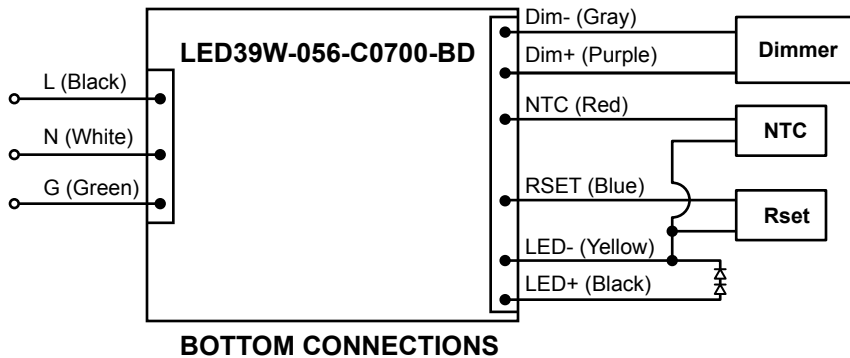

Programming The Driver Output

Select resistance (RSET) from the table for required output current (ILED). Connect as shown in the wiring diagram.

Rset Table

Rset(Ω)	ILED(mA)	Rset(Ω)	ILED(mA)	Rset(Ω)	ILED(mA)	Rset(Ω)	ILED(mA)	Rset(Ω)	ILED(mA)	Rset(Ω)	ILED(mA)
1Ω	191.1mA	10Ω	193.7mA	100Ω	217.7mA	1kΩ	372.7mA	10kΩ	622.5mA	100kΩ	691.2mA
1Ω	191.2mA	11Ω	194.0mA	110Ω	220.2mA	1.1kΩ	384.0mA	11kΩ	628.6mA	110kΩ	692.0mA
1Ω	191.2mA	12Ω	194.2mA	120Ω	222.7mA	1.2kΩ	394.5mA	12kΩ	633.8mA	120kΩ	692.7mA
1Ω	191.2mA	13Ω	194.5mA	130Ω	225.1mA	1.3kΩ	404.4mA	13kΩ	638.3mA	130kΩ	693.3mA
2Ω	191.3mA	15Ω	195.1mA	150Ω	230.0mA	1.5kΩ	422.3mA	15kΩ	645.6mA	150kΩ	694.2mA
2Ω	191.3mA	16Ω	195.3mA	160Ω	232.4mA	1.6kΩ	430.5mA	16kΩ	648.7mA	160kΩ	694.6mA
2Ω	191.4mA	18Ω	195.9mA	180Ω	237.1mA	1.8kΩ	445.5mA	18kΩ	653.9mA	180kΩ	695.2mA
2Ω	191.4mA	20Ω	196.5mA	200Ω	241.8mA	2kΩ	458.9mA	20kΩ	658.2mA	200kΩ	695.7mA
2Ω	191.5mA	22Ω	197.0mA	220Ω	246.3mA	2.2kΩ	470.9mA	22kΩ	661.7mA	220kΩ	696.1mA
2Ω	191.5mA	24Ω	197.6mA	240Ω	250.7mA	2.4kΩ	481.8mA	24kΩ	664.7mA	240kΩ	696.5mA
3Ω	191.6mA	27Ω	198.4mA	270Ω	257.3mA	2.7kΩ	496.4mA	27kΩ	668.4mA	270kΩ	696.9mA
3Ω	191.7mA	30Ω	199.2mA	300Ω	263.6mA	3kΩ	509.1mA	30kΩ	671.4mA	300kΩ	697.2mA
3Ω	191.8mA	33Ω	200.0mA	330Ω	269.7mA	3.3kΩ	520.4mA	33kΩ	673.9mA	330kΩ	697.5mA
4Ω	191.9mA	36Ω	200.8mA	360Ω	275.7mA	3.6kΩ	530.4mA	36kΩ	676.0mA	360kΩ	697.7mA
4Ω	192.0mA	39Ω	201.7mA	390Ω	281.5mA	3.9kΩ	539.3mA	39kΩ	677.8mA	390kΩ	697.9mA
4Ω	192.1mA	43Ω	202.7mA	430Ω	289.0mA	4.3kΩ	549.9mA	43kΩ	679.8mA	430kΩ	698.1mA
5Ω	192.2mA	47Ω	203.8mA	470Ω	296.3mA	4.7kΩ	559.1mA	47kΩ	681.4mA	470kΩ	698.3mA
5Ω	192.3mA	51Ω	204.9mA	510Ω	303.3mA	5.1kΩ	567.3mA	51kΩ	682.9mA	510kΩ	698.5mA
6Ω	192.4mA	56Ω	206.2mA	560Ω	311.7mA	5.6kΩ	576.3mA	56kΩ	684.4mA	560kΩ	698.6mA
6Ω	192.6mA	62Ω	207.8mA	620Ω	321.3mA	6.2kΩ	585.6mA	62kΩ	685.9mA	620kΩ	698.8mA
7Ω	192.8mA	68Ω	209.4mA	680Ω	330.5mA	6.8kΩ	593.6mA	68kΩ	687.1mA	680kΩ	698.9mA
8Ω	193.0mA	75Ω	211.2mA	750Ω	340.6mA	7.5kΩ	601.6mA	75kΩ	688.3mA	750kΩ	699.0mA
8Ω	193.2mA	82Ω	213.0mA	820Ω	350.2mA	8.2kΩ	608.5mA	82kΩ	689.3mA	820kΩ	699.1mA
9Ω	193.4mA	91Ω	215.4mA	910Ω	361.8mA	9.1kΩ	616.1mA	91kΩ	690.4mA	910kΩ	699.2mA

Notes:

1. Minimum wattage resistor rating is 1/8W leaded.
2. Larger wattages can be used for easy installation.
3. RSET best placed in LED engine to avoid field replacement programmability issues.
4. If RSET is placed on LED engine, SMD 0805 size is recommended.

0-10VDC Dimming

Parameters	Minimum	Typical	Maximum
Source Current out of 0-10V Purple Wire	0 mA	—	3 mA
Absolute Voltage Range on 0-10V (+) Purple Wire	-2.0 V	—	+15 V

Typical Dimming Circuit

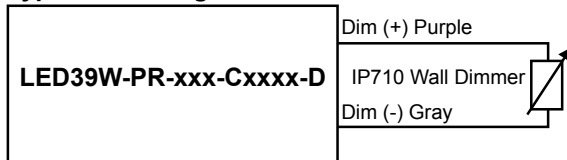

(Dimmer must be current-sink type control)

Output Current / 0-10VDC Dimming Control Voltage

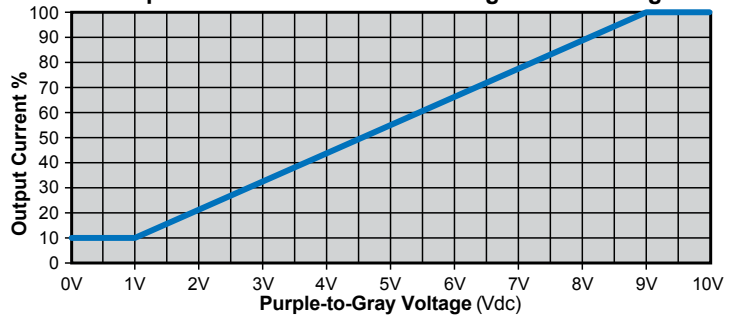

Notes:

1. Compatible with most 0-10V dimmers. Recommended dimmer is Leviton IP710 or equivalent.
2. Not intended to dim below about 10% @ 1.0V.
3. Output will be 100% with Purple/Gray open and minimum with Purple/Gray Shorted.
4. Make sure forward voltage at desired percentage dimming does not fall below minimum output voltage spec.

NTC

Select a Negative Thermal Coefficient (NTC) resistor with a resistance range that allows the full output current to flow at safe LED operating temperatures.

NTC resistance should drop sufficiently to allow reduced output current at elevated or harmful LED temperature levels.

NTC operation should be thoroughly tested to ensure proper operation over all the full temperature range of the Driver and the LED Engine.

NTC Tables

120Vac

RNTC (Ω)	I _{out} (A)
100	0.0892
1000	0.0892
2000	0.0892
2200	0.0892
2220	0.0923
2230	0.117
2240	0.167
2250	0.2196
2260	0.27
2270	0.31
2280	0.352
2290	0.394
2300	0.44
2310	0.489
2320	0.54
2330	0.587
2340	0.6324
2350	0.673
2360	0.698
2370	0.7
2380	0.7
2390	0.7001
2400	0.7002
2450	0.7001
2500	0.7001
3000	0.7002
4000	0.7002
5000	0.7002

277Vac

RNTC (Ω)	I _{out} (A)
100	0.0892
1000	0.0892
2000	0.0892
2200	0.0892
2220	0.0918
2230	0.113
2240	0.163
2250	0.2146
2260	0.2683
2270	0.3105
2280	0.351
2290	0.3951
2300	0.442
2310	0.4915
2320	0.542
2330	0.59
2340	0.636
2350	0.681
2360	0.698
2370	0.7
2380	0.7
2390	0.7001
2400	0.7002
2450	0.7001
2500	0.7001
3000	0.7002
4000	0.7002
5000	0.7002

Using Thermal Shutdown

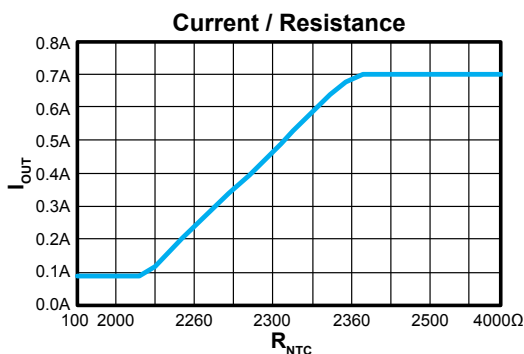

Note:

Disconnect power to LED driver for at least 30 seconds before connecting or disconnecting Driver output and LED Engine. This prevents potential arcing transients that can damage the Engine and Driver. See Hot Plugging in our Driver Application Guide for more information.