

High Frequency Ceramic Solutions

802.11 Dual Band 2.45/5 GHz Mini Chip Antenna. WiFi, WLAN, IoT

P/N 2450AD14A5500

Detail Specification: 3/10/2021

Page 1 of 14

AEC-Q200 qualification available.

Let us help you with the antenna design, optimization, and tuning!

<https://www.johansontechnology.com/ipc-antenna-services>

General Specifications		
Part Number	2450AD14A5500	
Frequency (MHz)	2400 - 2480	5150 - 5850
Avg. Rad Efficiency ¹	60%	80%
Peak Gain (dBi typ.)	1.0 dBi typ. (XZ-Total)	4.0 dBi typ. (XZ-Total)
Average Gain (dBi typ.)	-3.5 dBi typ. (XZ-Total)	-2.5 dBi typ. (XZ-Total)
Return Loss (dB)	7.2 typ. (2.7 min.)	9.5 typ. (3.95 min.)
Impedance (Ω)	50	
Input Power (W)	2 max. (CW)	
Quantity/Reel (pcs)	4,000	

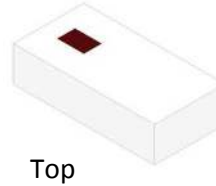

Top

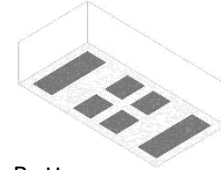

Botto

Operating Temperature	-40 to +85°C
Recommended Storage Conditions and Period for unused Product on T&R	+5 to +35°C Humidity 45~75% RH 18 months max.

¹Measured on 2450AD14A5500-EB2SMA eval-board (See pages 7-11 for details)

Part Number Explanation

P/N Suffix	Packing Style	Bulk (loose pcs.)	Suffix = S	e.g. 2450AD14A5500S
		T & R	Suffix = T	e.g. 2450AD14A5500T
		100% Tin	Suffix = None	e.g. 2450AD14A5500(T or S)
	Evaluation Board	2450AD14A5500-EB1SMA & 2450AD14A5500-EB2SMA see pages 2&7 for details		

Mechanical Dimensions

	In	mm
L	0.063 ± 0.004	1.60 ± 0.10
W	0.031 ± 0.004	0.80 ± 0.10
T	0.016 max.	0.40 max.
a	0.003 ± 0.004	0.086 ± 0.10
b	0.008 min.	0.208 min.
c	0.008 ± 0.001	0.20 ± 0.03
d	0.003 ± 0.001	0.085 ± 0.03
e	0.008 ± 0.002	0.215 ± 0.05
f	0.010 ± 0.002	0.25 ± 0.05
g	0.006 min.	0.15 min.
h	0.008 ± 0.001	0.20 ± 0.03

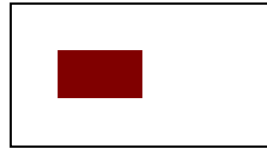

Top View

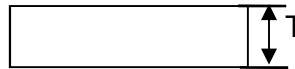

Side View

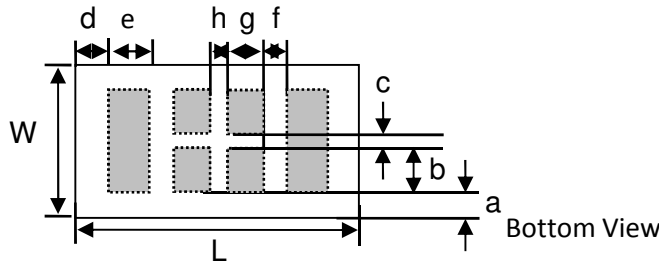

Bottom View

Terminal Configuration

No.	Function	
	Scenario 1	Scenario 2
1	GND	GND
2	FEED	NC
3	NC	NC
4	NC	FEED

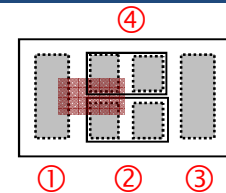

Top View, looking "through" the component

-Terminals 2 and 4 have *two* pads each
-Make sure to have Pin 3 soldered to its PCB land pad but not connected to GND or input, they must be NC (or floating). If unsoldered, it may affect improper antenna resonance and drop-shock resistance.

Johanson Technology, Inc. reserves the right to make design changes without notice.

All sales are subject to Johanson Technology, Inc. terms and conditions.



<https://www.johansontechnology.com>

4001 Calle Tecate • Camarillo, CA 93012 • TEL 805.389.1166 FAX 805.389.1821

Ver. 3.1

2021 Johanson Technology, Inc. All Rights Reserved

High Frequency Ceramic Solutions

802.11 Dual Band 2.45/5 GHz Mini Chip Antenna. WiFi, WLAN, IoT

P/N 2450AD14A5500

Detail Specification: 3/10/2021

Page 2 of 14

Mounting Considerations 1: Antenna PCB Layout (Scenario 1 Terminal Configuration)

Mount these devices with brown mark facing up.

PCB Layout (top)

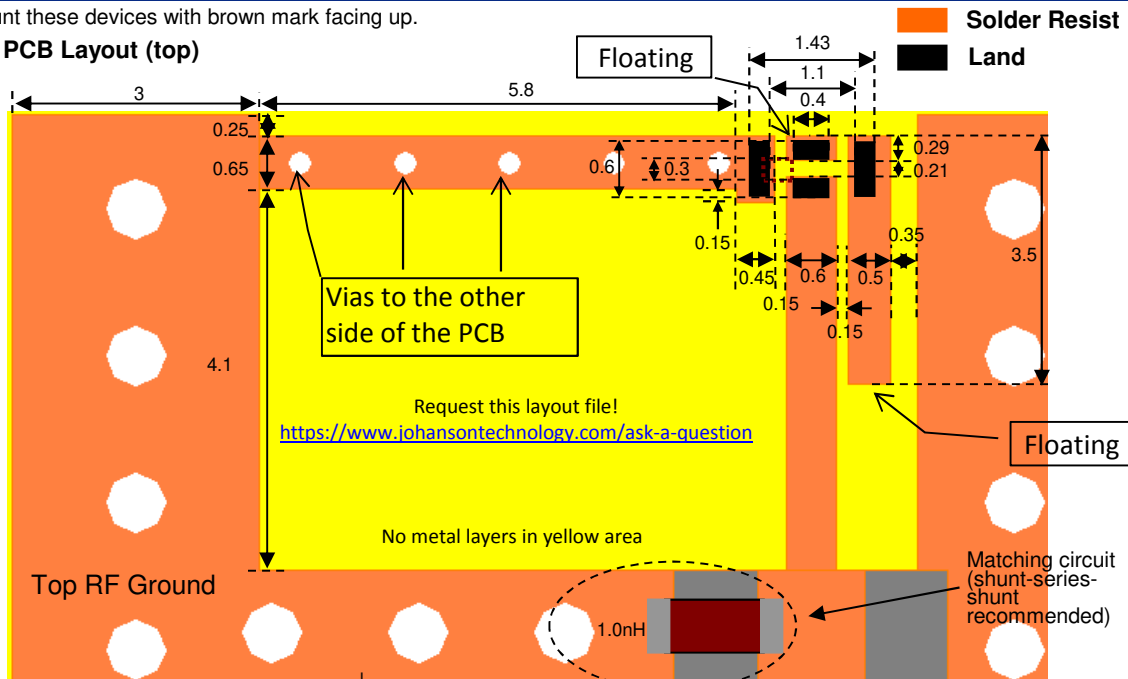

PCB Layout (bottom)

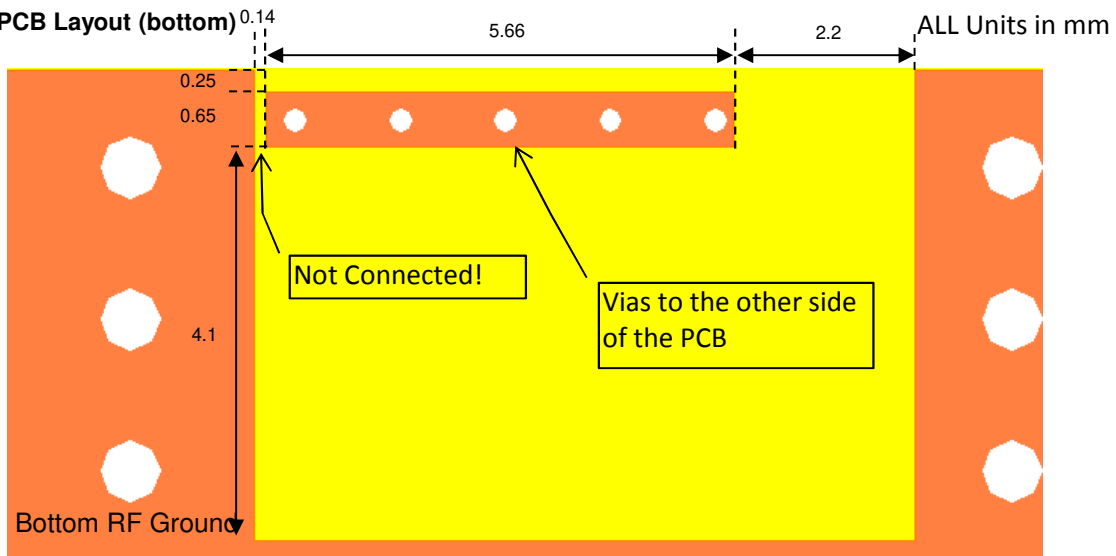

Johanson Technology, Inc. reserves the right to make design changes without notice.
 All sales are subject to Johanson Technology, Inc. terms and conditions.

High Frequency Ceramic Solutions

802.11 Dual Band 2.45/5 GHz Mini Chip Antenna. WiFi, WLAN, IoT

P/N 2450AD14A5500

Detail Specification: 3/10/2021

Page 3 of 14

Mounting Consideration 1: Evaluation Board, 40x70mm (Scenario 1 Terminal Configuration)

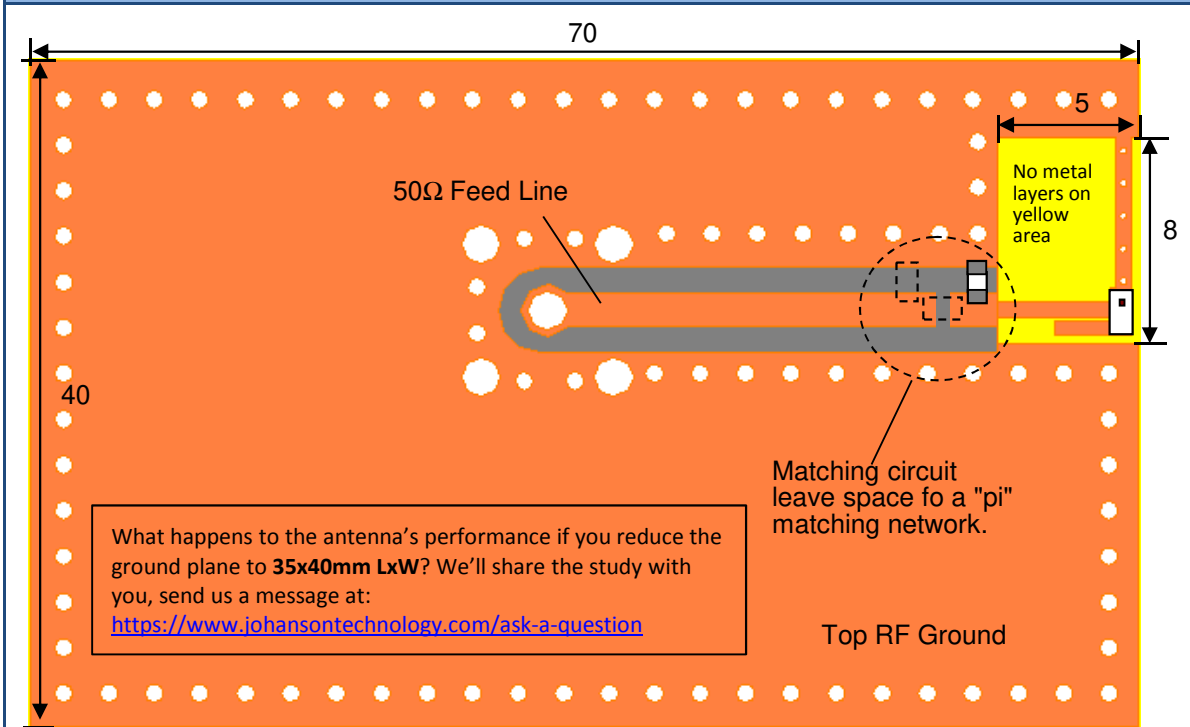

Frequency (GHz)	Radiated Efficiency (%)
2.44	66
5.5	79

Units in mm

To order the ABOVE pre-tuned 50Ω EVB with a female SMA connector click

here: <https://www.johansontechnology.com/request-a-sample>

Reference p/n: 2450AD14A5500-EB1SMA

Would you like the layout file of the above? Have antenna tuning issues?

Please contact us if you have any questions regarding the implementation of this antenna in your PCB's layout. We'll be happy to guide you to maximize the antenna's performance.

Contact our applications engineers at:

<https://www.johansontechnology.com/ask-a-question>

Johanson Technology, Inc. reserves the right to make design changes without notice.
All sales are subject to Johanson Technology, Inc. terms and conditions.

High Frequency Ceramic Solutions

802.11 Dual Band 2.45/5 GHz Mini Chip Antenna. WiFi, WLAN, IoT

P/N 2450AD14A5500

Detail Specification: 3/10/2021

Page 4 of 14

Mounting Consideration 1: Evaluation Board, 40x70mm Typical Electrical Performance (T=25°C)

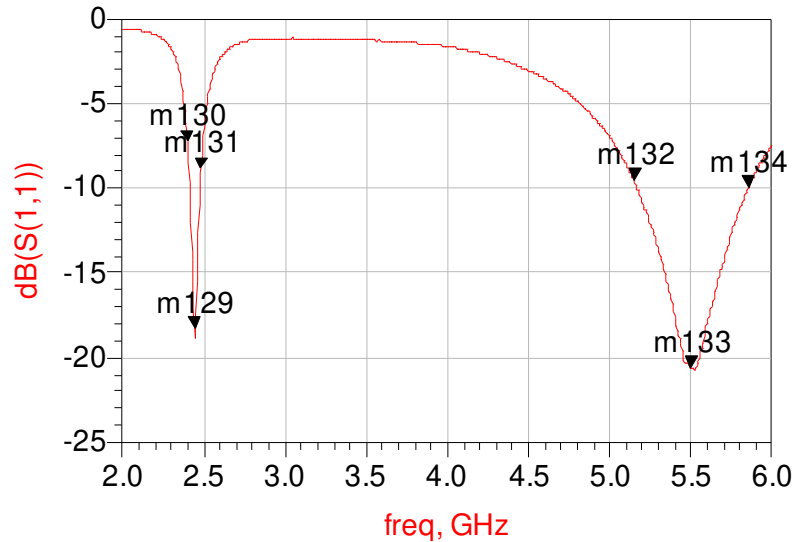

m130 freq=2.400GHz dB(S(1,1))=-7.250	m129 freq=2.442GHz dB(S(1,1))=-18.254	m131 freq=2.484GHz dB(S(1,1))=-8.854
m132 freq=5.150GHz dB(S(1,1))=-9.557	m133 freq=5.500GHz dB(S(1,1))=-20.673	m134 freq=5.850GHz dB(S(1,1))=-10.013

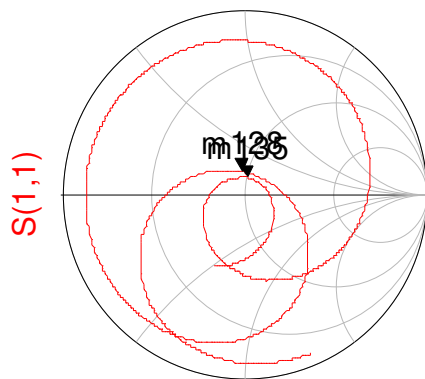

m128
freq=2.442GHz
S(1,1)=0.122 / 95.014
impedance = 47.527 + j11.753

m135
freq=5.500GHz
S(1,1)=0.093 / 81.368
impedance = 50.543 + j9.329

freq (2.000GHz to 6.000GHz)

Johanson Technology, Inc. reserves the right to make design changes without notice.
All sales are subject to Johanson Technology, Inc. terms and conditions.

High Frequency Ceramic Solutions

802.11 Dual Band 2.45/5 GHz Mini Chip Antenna. WiFi, WLAN, IoT

P/N 2450AD14A5500

Detail Specification: 3/10/2021

Page 5 of 14

Mounting Consideration 1: Evaluation Board, 40x70mm Typical EM Radiation Performance @2.44GHz (T=25°C)

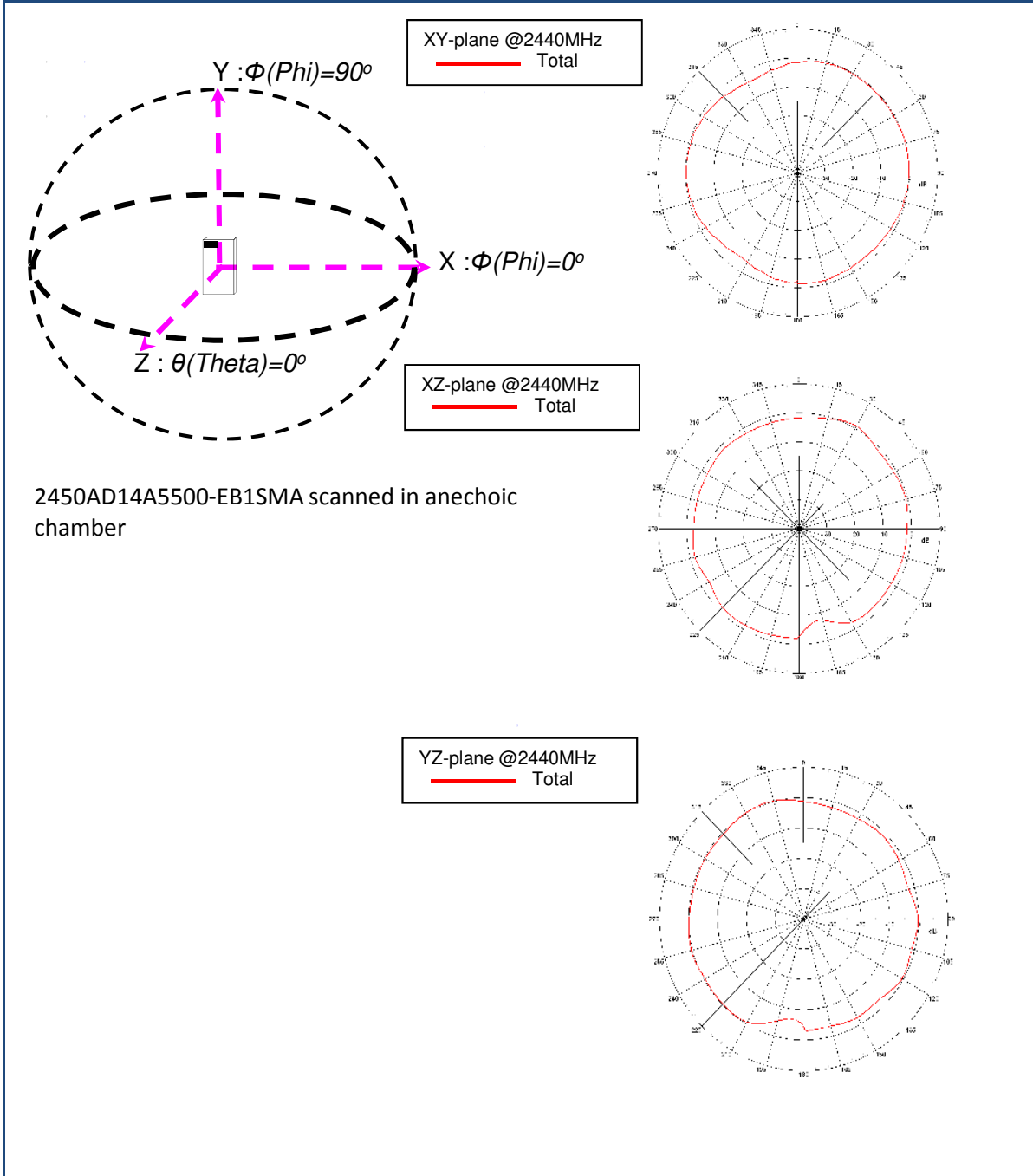

Johanson Technology, Inc. reserves the right to make design changes without notice.
All sales are subject to Johanson Technology, Inc. terms and conditions.



<https://www.johansontechnology.com>

4001 Calle Tecate • Camarillo, CA 93012 • TEL 805.389.1166 FAX 805.389.1821

Ver. 3.1

2021 Johanson Technology, Inc. All Rights Reserved

High Frequency Ceramic Solutions

802.11 Dual Band 2.45/5 GHz Mini Chip Antenna. WiFi, WLAN, IoT

P/N 2450AD14A5500

Detail Specification: 3/10/2021

Page 6 of 14

Mounting Consideration 1: Evaluation Board, 40x70mm Typical EM Radiation Performance @5.50GHz (T=25°C)

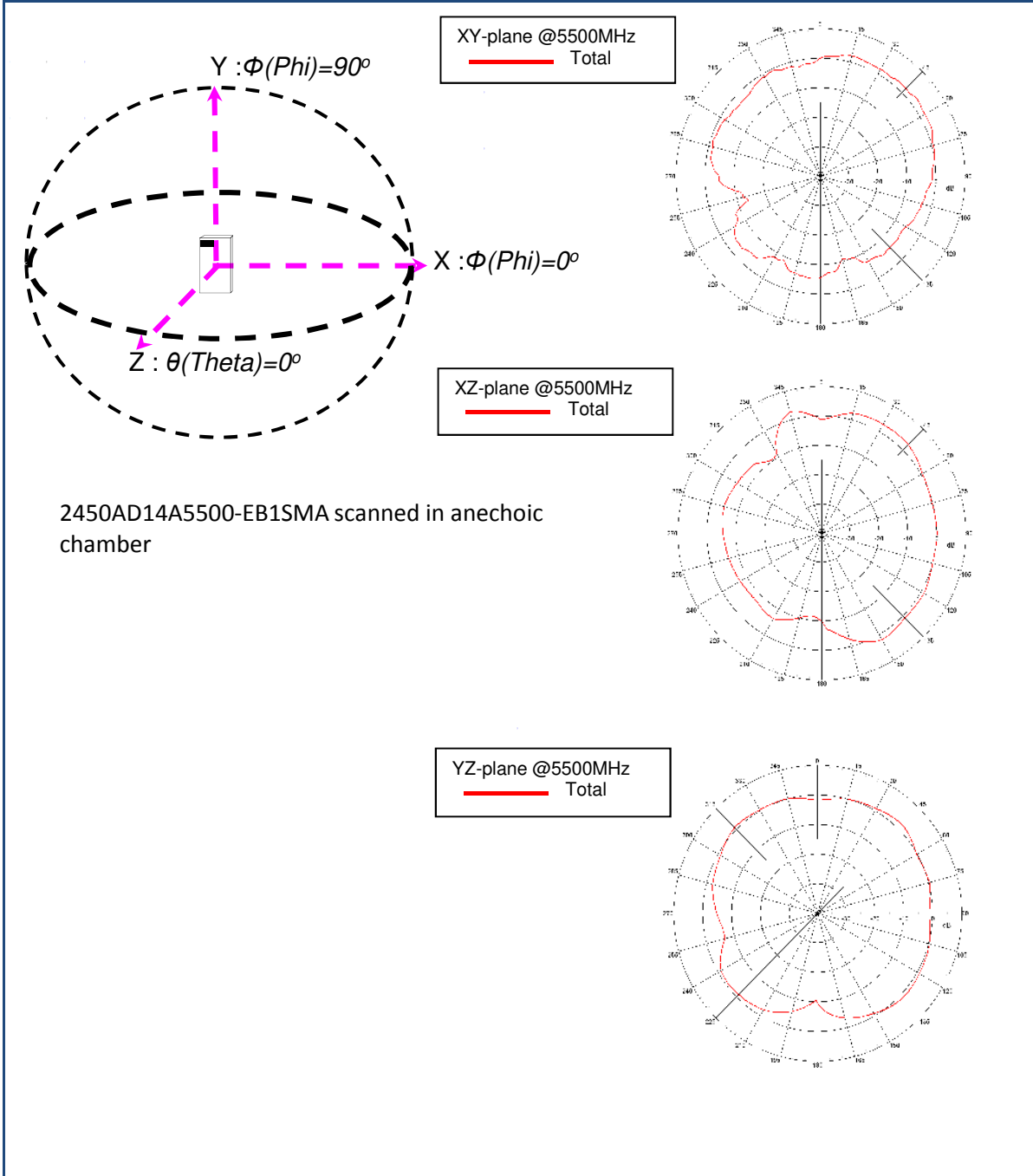

Johanson Technology, Inc. reserves the right to make design changes without notice.
All sales are subject to Johanson Technology, Inc. terms and conditions.



High Frequency Ceramic Solutions

802.11 Dual Band 2.45/5 GHz Mini Chip Antenna. WiFi, WLAN, IoT

P/N 2450AD14A5500

Detail Specification: 3/10/2021

Page 7 of 14

Mounting Consideration 2: Evaluation Board, 65x120mm (Scenario 1 Terminal Configuration)

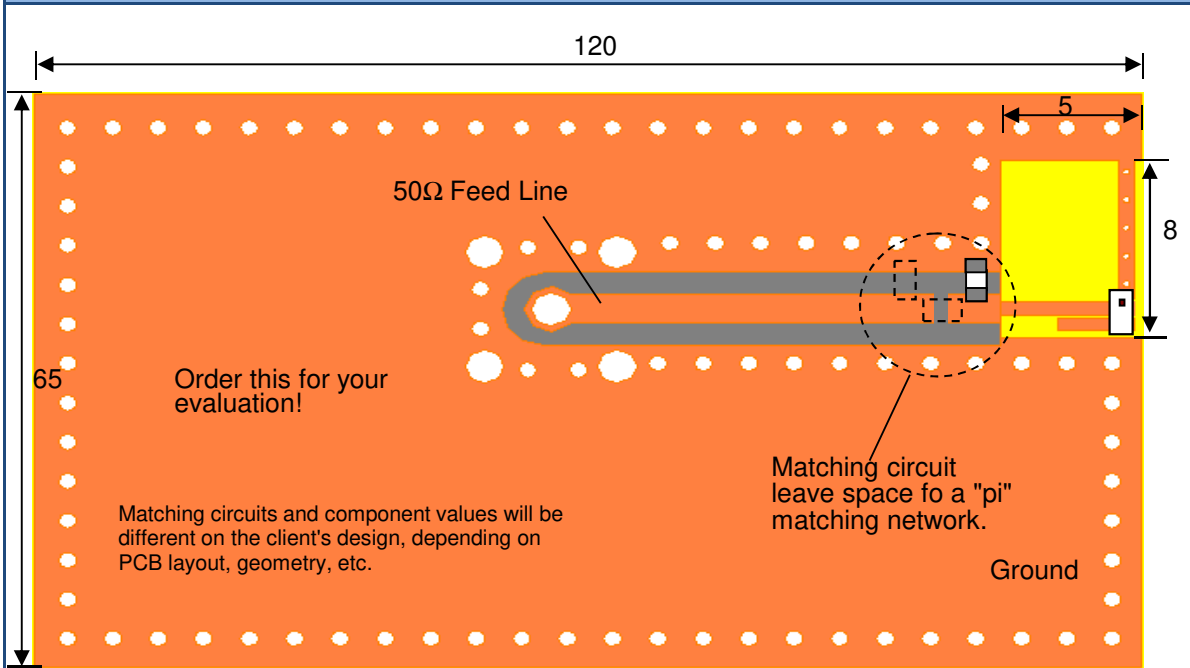

Units in mm

Frequency (GHz)	Radiated Efficiency (%)
2.44	60
5.5	86

To order the ABOVE pre-tuned 50Ω EVB with a female SMA connector click

here: <https://www.johansontechnology.com/request-a-sample>

Reference p/n: 2450AD14A5500-EB2SMA

Would you like the layout file of the above? Have antenna tuning issues?

Please contact us if you have any questions regarding the implementation of this antenna in your PCB's layout. We'll be happy to guide you to maximize the antenna's performance.

Contact our applications engineers at:

<https://www.johansontechnology.com/ask-a-question>

Johanson Technology, Inc. reserves the right to make design changes without notice.

All sales are subject to Johanson Technology, Inc. terms and conditions.



<https://www.johansontechnology.com>

4001 Calle Tecate • Camarillo, CA 93012 • TEL 805.389.1166 FAX 805.389.1821

Ver. 3.1

2021 Johanson Technology, Inc. All Rights Reserved

High Frequency Ceramic Solutions

802.11 Dual Band 2.45/5 GHz Mini Chip Antenna. WiFi, WLAN, IoT

P/N 2450AD14A5500

Detail Specification: 3/10/2021

Page 8 of 14

Mounting Consideration 2: Evaluation Board, 65x120mm Typical Electrical Performance (T=25°C)

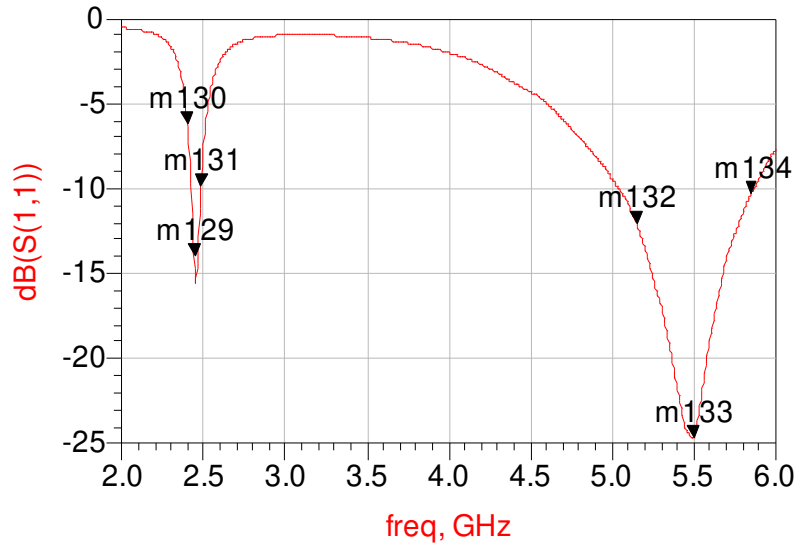

m130 freq=2.400GHz dB(S(1,1))=-6.202	m129 freq=2.442GHz dB(S(1,1))=-14.010	m131 freq=2.484GHz dB(S(1,1))=-9.880
m132 freq=5.150GHz dB(S(1,1))=-12.060	m133 freq=5.500GHz dB(S(1,1))=-24.657	m134 freq=5.850GHz dB(S(1,1))=-10.323

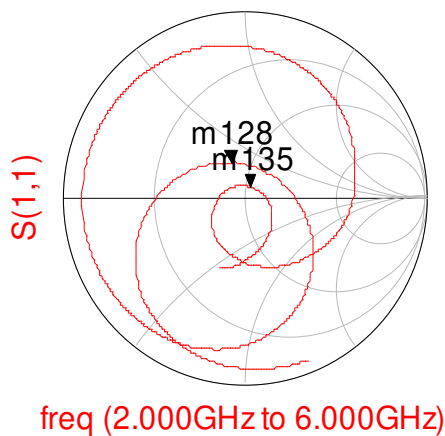

m128
freq=2.442GHz
S(1,1)=0.199 / 110.889
impedance = 40.626 + j15.755

m135
freq=5.500GHz
S(1,1)=0.059 / 59.150
impedance = 52.817 + j5.324

Johanson Technology, Inc. reserves the right to make design changes without notice.
All sales are subject to Johanson Technology, Inc. terms and conditions.

High Frequency Ceramic Solutions

802.11 Dual Band 2.45/5 GHz Mini Chip Antenna. WiFi, WLAN, IoT

P/N 2450AD14A5500

Detail Specification: 3/10/2021

Page 9 of 14

Mounting Consideration 2: Evaluation Board, 65x120mm Typical EM Radiation Performance @2.44GHz (T=25°C)

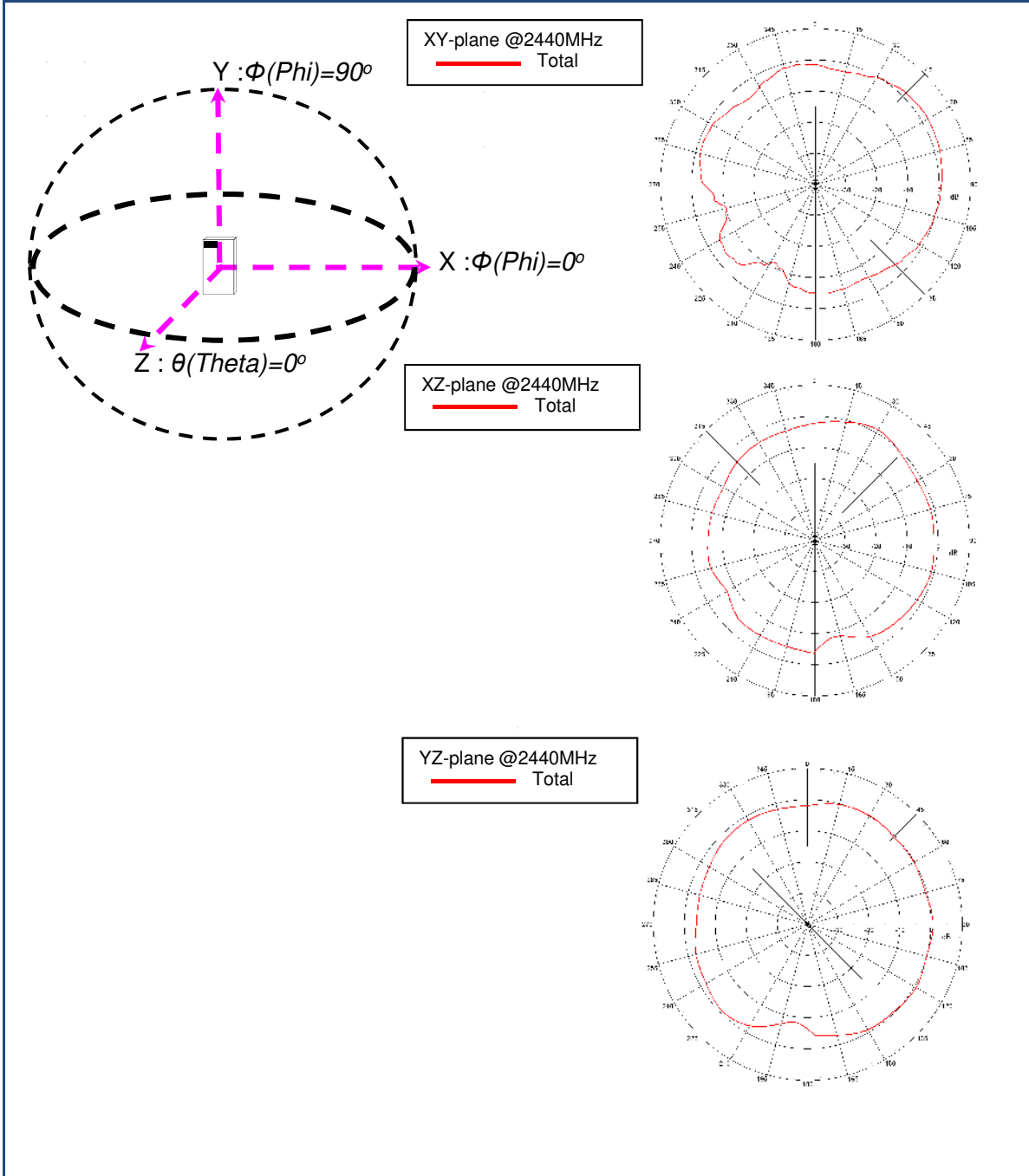

Johanson Technology, Inc. reserves the right to make design changes without notice.
All sales are subject to Johanson Technology, Inc. terms and conditions.

High Frequency Ceramic Solutions

802.11 Dual Band 2.45/5 GHz Mini Chip Antenna. WiFi, WLAN, IoT

P/N 2450AD14A5500

Detail Specification: 3/10/2021

Page 10 of 14

Mounting Consideration 2: Evaluation Board, 65x120mm Typical EM Radiation Performance @5.50GHz (T=25°C)

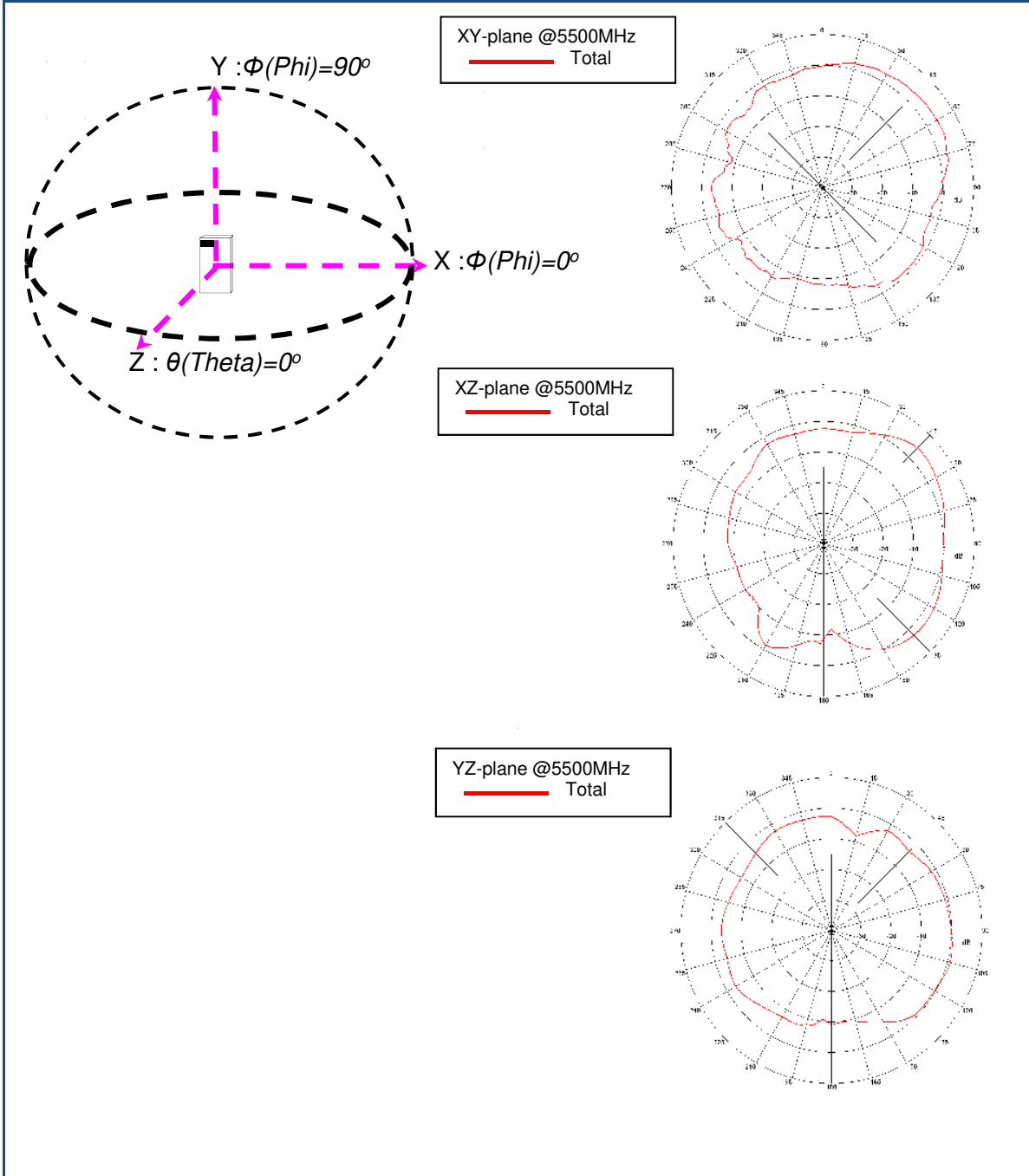

Johanson Technology, Inc. reserves the right to make design changes without notice.
All sales are subject to Johanson Technology, Inc. terms and conditions.



High Frequency Ceramic Solutions

802.11 Dual Band 2.45/5 GHz Mini Chip Antenna. WiFi, WLAN, IoT

P/N 2450AD14A5500

Detail Specification: 3/10/2021

Page 11 of 14

Mounting Consideration 3: Scenario 2 Terminal Configuration

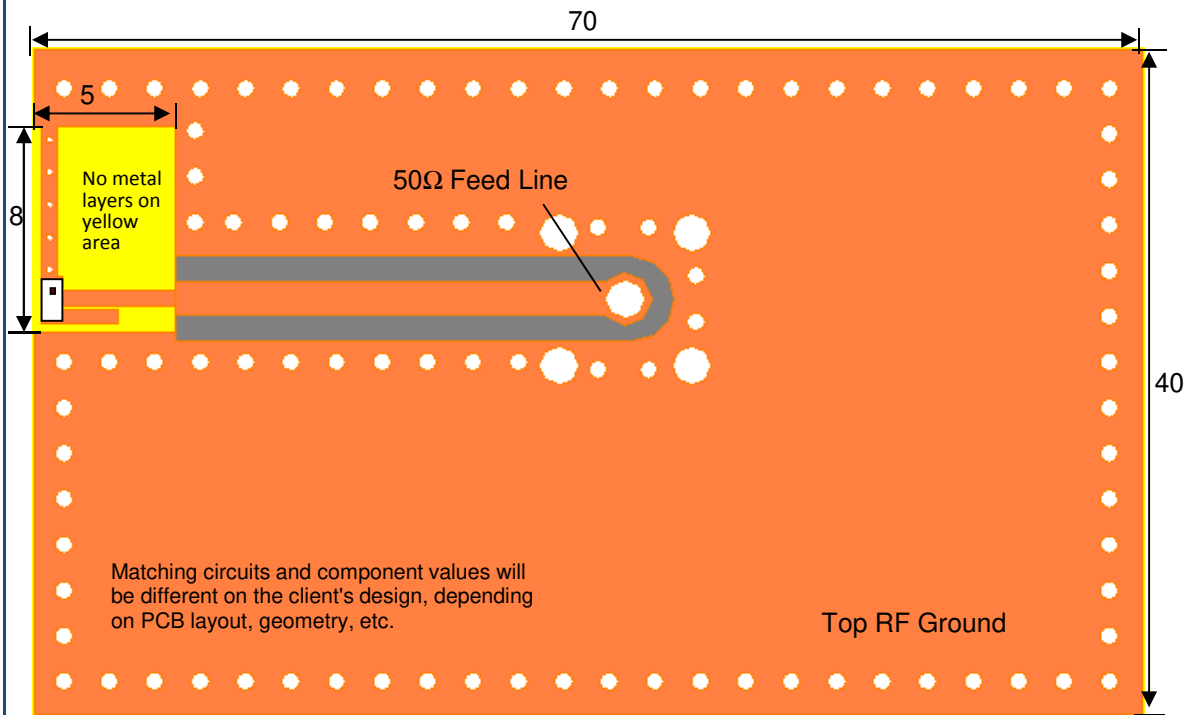

Units in mm

Would you like the layout file of the above? Have antenna tuning issues?
Please contact us if you have any questions regarding the implementation of this antenna in your PCB's layout. We'll be happy to guide you to maximize the antenna's performance.
Contact our applications engineers at:

<https://www.johansontechnology.com/ask-a-question>

Would you like to know what happens to the antenna's performance if you reduce the ground plane to half (**35x40mm LxW**)? We'll share the study with you, send us a message at: <https://www.johansontechnology.com/ask-a-question>

Johanson Technology, Inc. reserves the right to make design changes without notice.
All sales are subject to Johanson Technology, Inc. terms and conditions.



<https://www.johansontechnology.com>
4001 Calle Tecate • Camarillo, CA 93012 • TEL 805.389.1166 FAX 805.389.1821
Ver. 3.1 2021 Johanson Technology, Inc. All Rights Reserved

High Frequency Ceramic Solutions

802.11 Dual Band 2.45/5 GHz Mini Chip Antenna. WiFi, WLAN, IoT

P/N 2450AD14A5500

Detail Specification: 3/10/2021

Page 12 of 14

Mounting Consideration 3: Scenario 2 Terminal Configuration

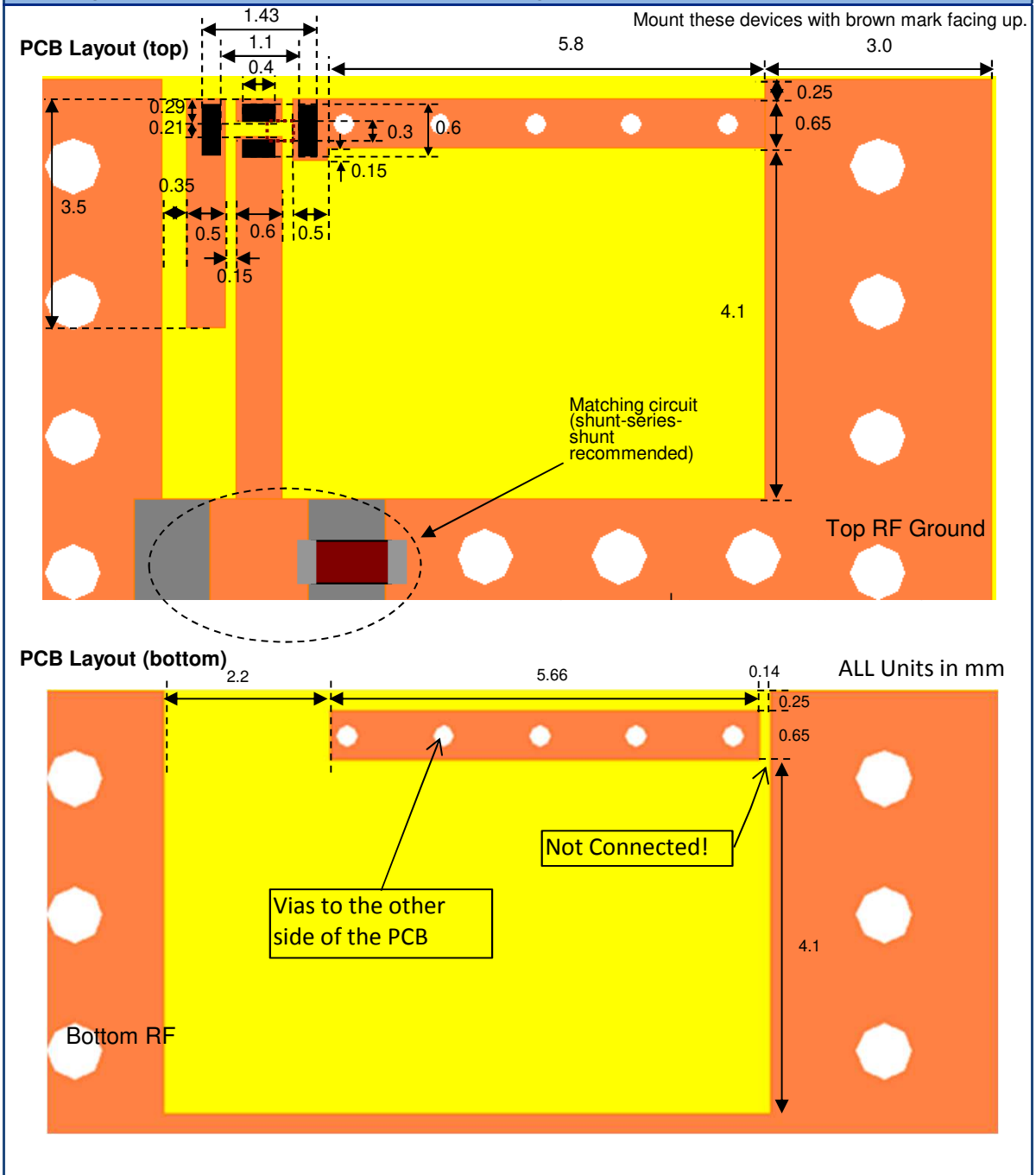

Johanson Technology, Inc. reserves the right to make design changes without notice.
All sales are subject to Johanson Technology, Inc. terms and conditions.



<https://www.johansontechnology.com>

4001 Calle Tecate • Camarillo, CA 93012 • TEL 805.389.1166 FAX 805.389.1821

Ver. 3.1

2021 Johanson Technology, Inc. All Rights Reserved

High Frequency Ceramic Solutions

802.11 Dual Band 2.45/5 GHz Mini Chip Antenna. WiFi, WLAN, IoT

P/N 2450AD14A5500

Detail Specification: 3/10/2021

Page 13 of 14

Single Feed Configuration with Diplexer Option

If the single feed option is preferred, Johanson Technology has several chip diplexer options to both separate and filter the 2G and 5G signals. These diplexers are identical in size as the antenna itself and can be mounted just prior to the matching network of the antenna.

Pairing a 2.4GHz low pass filter with a 5.4GHz band pass filter not only separates the two signals but provides harmonic attenuation to fulfill regulation qualification for industry standards.

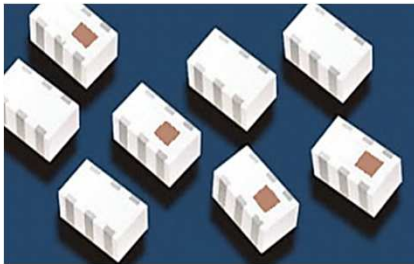

For more information about our diplexers go to:
<https://www.johansontechnology.com/diplexers>

For assistance with PCB layout or general component inquiries, please go to:
<https://www.johansontechnology.com/ask-a-question>

Example part numbers include 2450DP14C5400, 2450DP14D5400

Mini chip diplexer footprint and example layout

2450AD14A5500
Dual Band Antenna

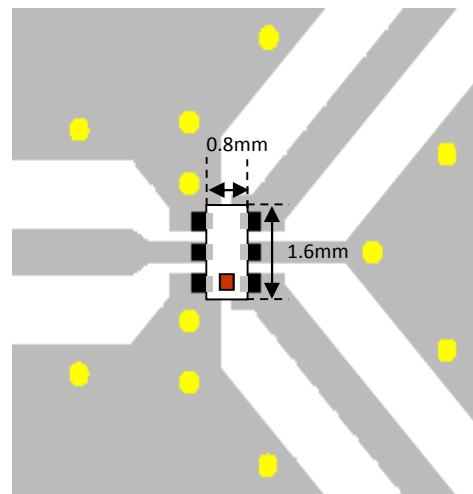
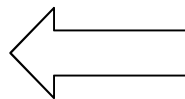

Johanson Technology, Inc. reserves the right to make design changes without notice.
All sales are subject to Johanson Technology, Inc. terms and conditions.

High Frequency Ceramic Solutions

802.11 Dual Band 2.45/5 GHz Mini Chip Antenna. WiFi, WLAN, IoT

P/N 2450AD14A5500

Detail Specification: 3/10/2021

Page 14 of 14

Antenna tuning, optimization, and validation services:

<https://www.johansontechnology.com/ipc-antenna-services>

For more antennas and to download measured S-parameters, go to:

<https://www.johansontechnology.com/antennas>

For more information about our diplexers:

<https://www.johansontechnology.com/diplexers>

Soldering Information

<https://www.johansontechnology.com/ipcsoldering-profile>

MSL Info

<https://www.johansontechnology.com/msl-rating>

Packaging information

<https://www.johansontechnology.com/tape-reel-packaging>

For layout review contact our Applications Team at:

<https://www.johansontechnology.com/ask-a-question>

RoHS Compliance

<https://www.johansontechnology.com/rohs-compliance>

Need help designing the antenna in? Use our antenna design services!

<https://www.johansontechnology.com/ipc-antenna-services>

2 free layout reviews and if you need us to tune and characterize the antenna on your product (inside anechoic chamber) we can do that too. Small lab fee may apply for the latter.

Johanson Technology, Inc. reserves the right to make design changes without notice.
All sales are subject to Johanson Technology, Inc. terms and conditions.



<https://www.johansontechnology.com>

4001 Calle Tecate • Camarillo, CA 93012 • TEL 805.389.1166 FAX 805.389.1821

Ver. 3.1

2021 Johanson Technology, Inc. All Rights Reserved