

AN-1843 LM2833X WSON Demo Board

1 Introduction

The LM2833X WSONdemo board is designed to demonstrate the capabilities of the LM2833X 1.5MHz switching regulator in an WSON-10 package.

The demo board is configured to provide an output of 1.2V at up to 3A from an input voltage range of 3V to 5.5V. The board is thermally optimized with the small solution size of 1.2" X 1.1", shown in the demo board schematic in [Figure 1](#). The output voltage can be configured to a different value by changing the ratio between R1 and R2 according to the following equation:

$$R1 = R2 \times (VOUT / VFB - 1) \quad (1)$$

The feedback voltage VFB is regulated at 0.60V typically.

The board has C5 reserved for two purposes, given different application scenarios. First, at high VOUT applications, the control loop bandwidth is not as large as at low VOUT. Adding C5 at high VOUT can significantly improve the load step response by boosting the loop bandwidth without significantly compromising phase margin. Secondly, it also helps to minimize output voltage overshoot during sluggish startup, short circuit release, and recovery from thermal shutdown, since it creates a feed-forward path between VOUT and VFB, thus speeding up Gm-amplifier recovery. In practice, for a few kΩ of voltage divider bottom resistor R2, a 47nF ceramic capacitor is usually a good choice for C5. Note for applications where VOUT is close to VFB, since R1 is small, the effectiveness of adding C5 becomes decreasingly appreciable. Therefore, other measures need to be taken to achieve the desired performance. For example, to minimize output overshoot during slow startup at high VOUT, an alternative approach is to apply a separate signal at the EN terminal after VIN is fully established.

Another component which is not populated on the board is C4, which is reserved for applications where a large output capacitor is desired.

[Table 1](#) lists the bill of materials of this demo board. The measured performance characteristics and layout of this board are also included below.

2 Powering Up The Board

Powering up the LM2833X WSON demo board is a single-step procedure, simply by applying a DC voltage of 3V to 5.5V to VIN and GND terminals. By default, VINC is connected to VIN through a low pass filter to remove any high frequency noise present at the input. EN is connected to VINC through a 100kΩ resistor. A separate logic signal at the EN terminal can be used, if startup and shutdown need to be controlled. A load can be connected between VOUT and GND terminals before or after the board is powered up. At VOUT of 1.2V, the internal soft-start circuit can bring up VOUT smoothly regardless of load or input voltage.

The LM2833X is designed to skip some pulses at very light loads to maintain output voltage regulation. Depending on load levels, the circuit may operate in either discontinuous or continuous conduction mode.

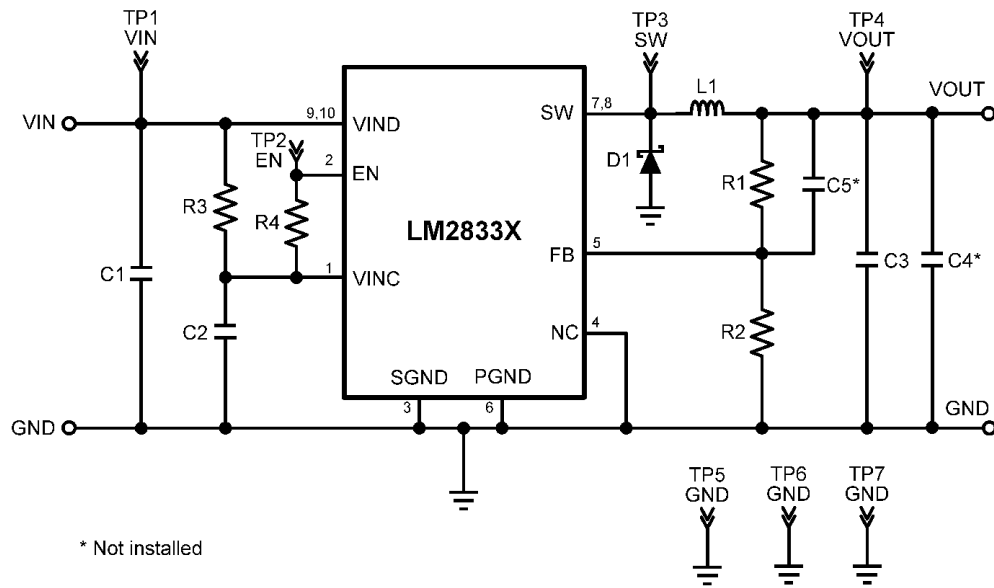
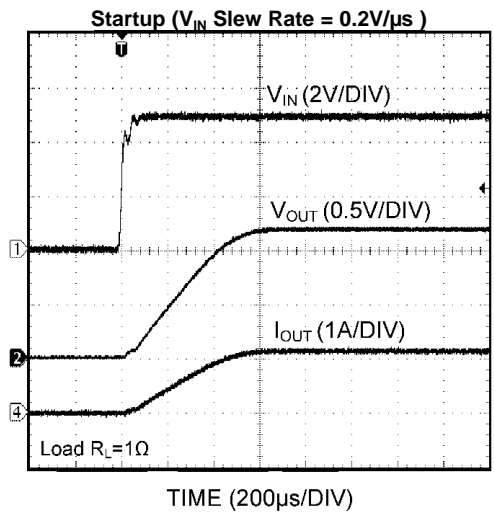
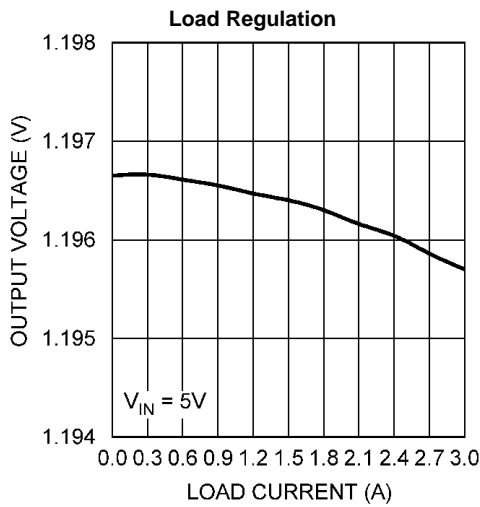
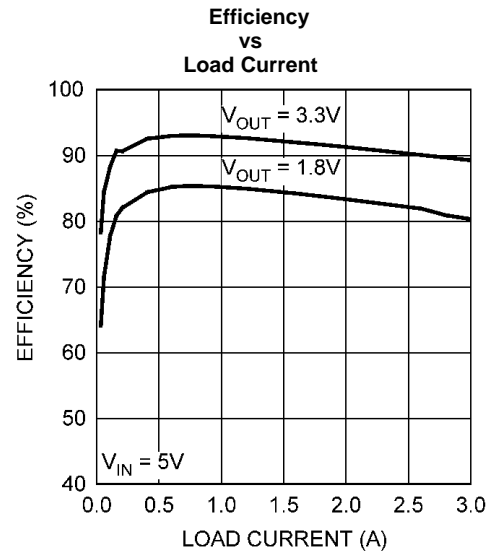
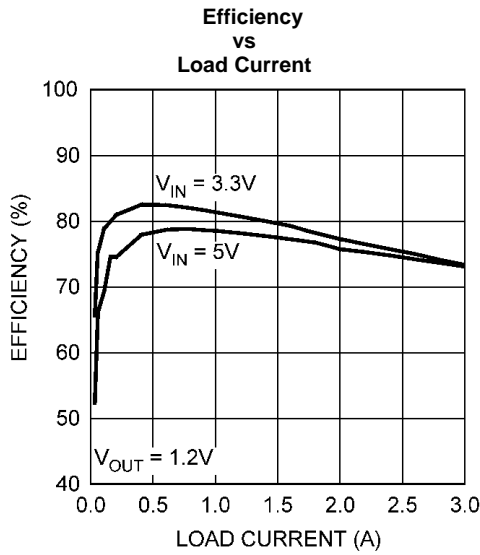
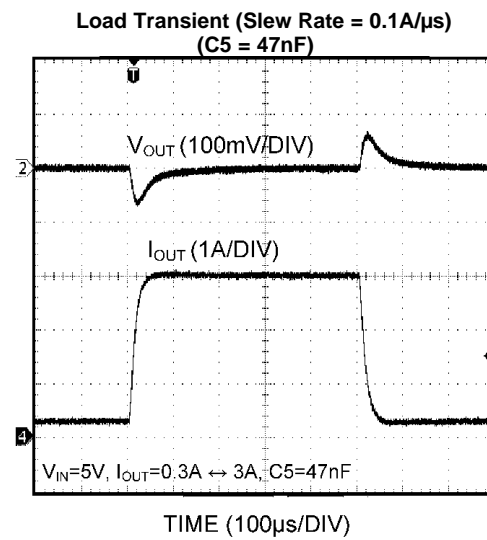
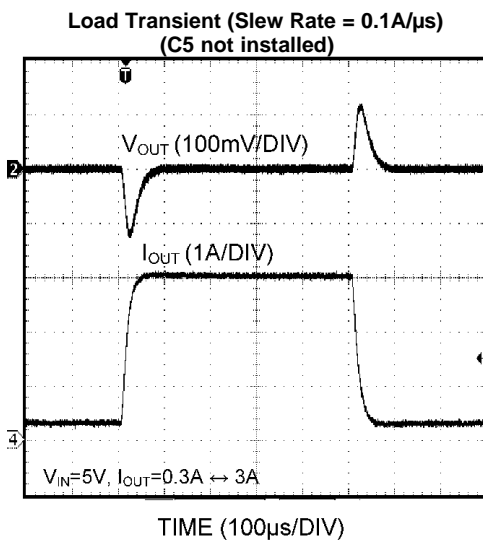
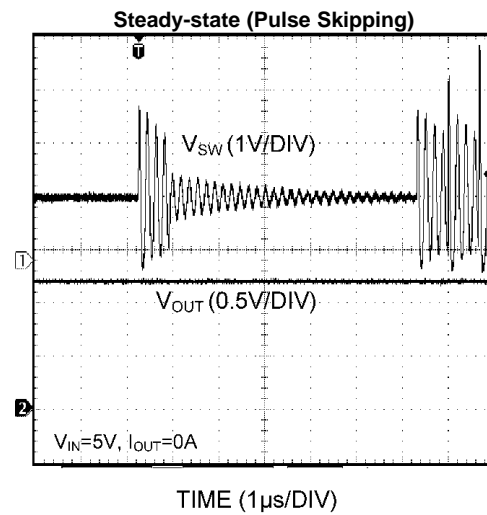
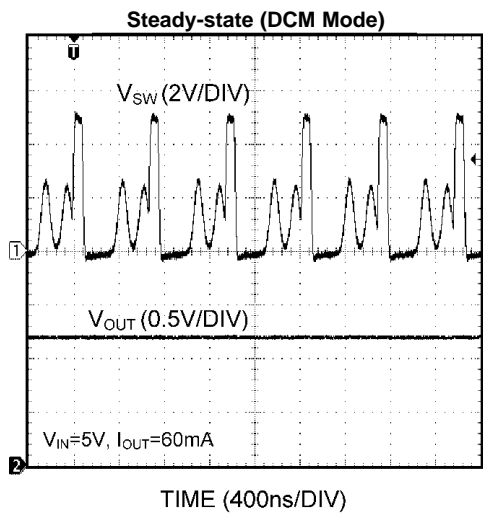
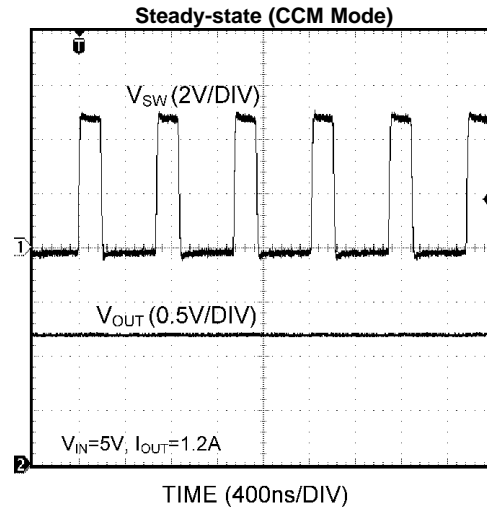
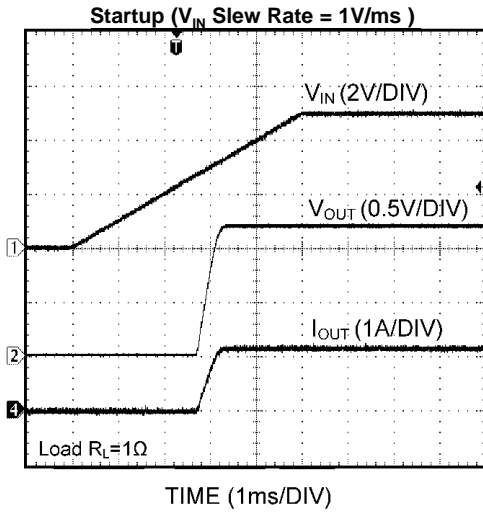
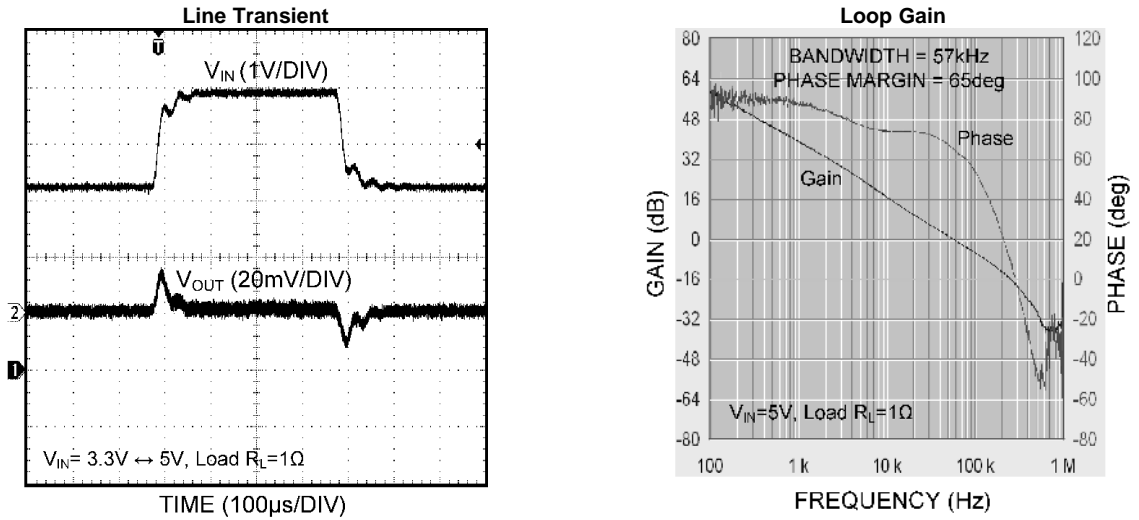

Figure 1. LM2833X WSON Demo Board Schematic

3 Typical Performance Characteristics







4 Layout

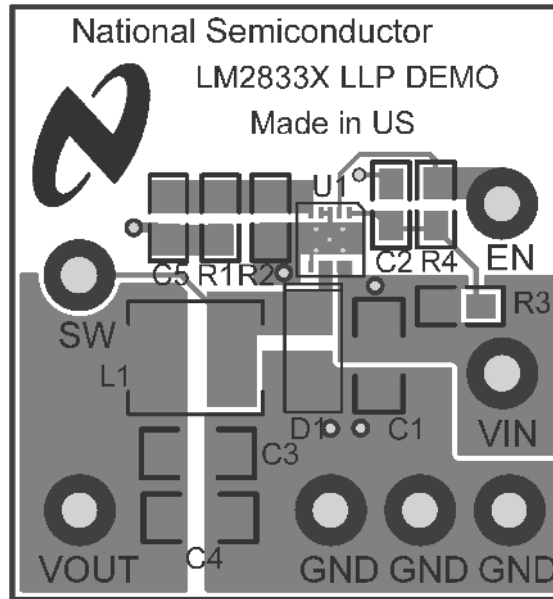

Figure 2. Top Layer and Top Overlay

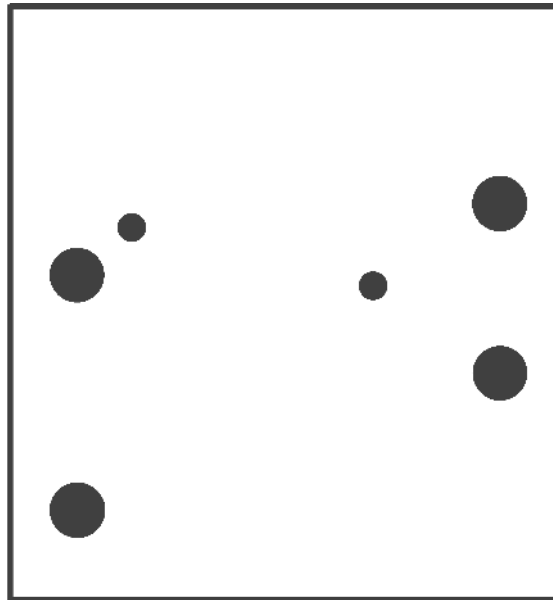

Figure 3. Internal Plane 1 (GND)

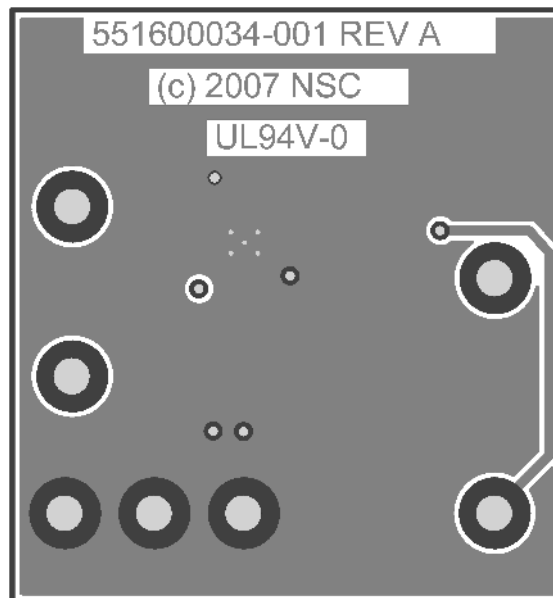

Figure 4. Bottom Layer

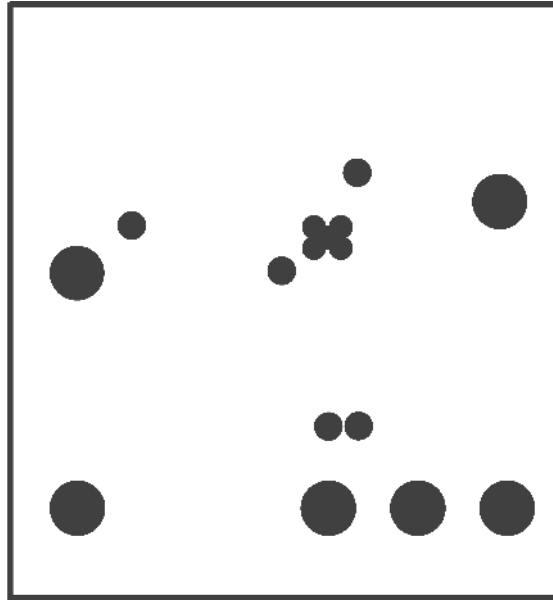

Figure 5. Internal Plane 2 (VIN)

5 Bill of Materials

Table 1. Bill of Materials

Part ID	Part Value	Part Number	Manufacturer
U1	1.5MHz 3.0A buck regulator, WSON-10	LM2833	Texas Instruments
L1	1.8 μ H, 3.6A, 5x5.2x2.2mm ³	LTF5022T-1R8N3R6	TDK
C1	22 μ F, 6.3V, X5R, 1206	C3216X5R0J226MT	TDK
C2	0.22 μ F, 10V, X7R, 0805	GRM216R71A224KC01D	Murata
C3	47 μ F, 6.3V, X5R, 1206	JMK316BJ476ML-T	Taiyo Yuden
C4	Open		
C5	Open		
D1	Schottky, 30V, 3A, 3-4E1A	CMS01	Toshiba
R1	2.00k Ω , 1%, 1/8W, 0805	CRCW08052K00FKEA	Vishay
R2	2.00k Ω , 1%, 1/8W, 0805	CRCW08052K00FKEA	Vishay
R3	10.0 Ω , 1%, 1/8W, 0805	CRCW080510R0FKEA	Vishay
R4	100k Ω , 1%, 1/8W, 0805	CRCW0805100KFKEA	Vishay

IMPORTANT NOTICE

Texas Instruments Incorporated and its subsidiaries (TI) reserve the right to make corrections, enhancements, improvements and other changes to its semiconductor products and services per JESD46, latest issue, and to discontinue any product or service per JESD48, latest issue. Buyers should obtain the latest relevant information before placing orders and should verify that such information is current and complete. All semiconductor products (also referred to herein as "components") are sold subject to TI's terms and conditions of sale supplied at the time of order acknowledgment.

TI warrants performance of its components to the specifications applicable at the time of sale, in accordance with the warranty in TI's terms and conditions of sale of semiconductor products. Testing and other quality control techniques are used to the extent TI deems necessary to support this warranty. Except where mandated by applicable law, testing of all parameters of each component is not necessarily performed.

TI assumes no liability for applications assistance or the design of Buyers' products. Buyers are responsible for their products and applications using TI components. To minimize the risks associated with Buyers' products and applications, Buyers should provide adequate design and operating safeguards.

TI does not warrant or represent that any license, either express or implied, is granted under any patent right, copyright, mask work right, or other intellectual property right relating to any combination, machine, or process in which TI components or services are used. Information published by TI regarding third-party products or services does not constitute a license to use such products or services or a warranty or endorsement thereof. Use of such information may require a license from a third party under the patents or other intellectual property of the third party, or a license from TI under the patents or other intellectual property of TI.

Reproduction of significant portions of TI information in TI data books or data sheets is permissible only if reproduction is without alteration and is accompanied by all associated warranties, conditions, limitations, and notices. TI is not responsible or liable for such altered documentation. Information of third parties may be subject to additional restrictions.

Resale of TI components or services with statements different from or beyond the parameters stated by TI for that component or service voids all express and any implied warranties for the associated TI component or service and is an unfair and deceptive business practice. TI is not responsible or liable for any such statements.

Buyer acknowledges and agrees that it is solely responsible for compliance with all legal, regulatory and safety-related requirements concerning its products, and any use of TI components in its applications, notwithstanding any applications-related information or support that may be provided by TI. Buyer represents and agrees that it has all the necessary expertise to create and implement safeguards which anticipate dangerous consequences of failures, monitor failures and their consequences, lessen the likelihood of failures that might cause harm and take appropriate remedial actions. Buyer will fully indemnify TI and its representatives against any damages arising out of the use of any TI components in safety-critical applications.

In some cases, TI components may be promoted specifically to facilitate safety-related applications. With such components, TI's goal is to help enable customers to design and create their own end-product solutions that meet applicable functional safety standards and requirements. Nonetheless, such components are subject to these terms.

No TI components are authorized for use in FDA Class III (or similar life-critical medical equipment) unless authorized officers of the parties have executed a special agreement specifically governing such use.

Only those TI components which TI has specifically designated as military grade or "enhanced plastic" are designed and intended for use in military/aerospace applications or environments. Buyer acknowledges and agrees that any military or aerospace use of TI components which have **not** been so designated is solely at the Buyer's risk, and that Buyer is solely responsible for compliance with all legal and regulatory requirements in connection with such use.

TI has specifically designated certain components as meeting ISO/TS16949 requirements, mainly for automotive use. In any case of use of non-designated products, TI will not be responsible for any failure to meet ISO/TS16949.

Products

Audio	www.ti.com/audio
Amplifiers	amplifier.ti.com
Data Converters	dataconverter.ti.com
DLP® Products	www.dlp.com
DSP	dsp.ti.com
Clocks and Timers	www.ti.com/clocks
Interface	interface.ti.com
Logic	logic.ti.com
Power Mgmt	power.ti.com
Microcontrollers	microcontroller.ti.com
RFID	www.ti-rfid.com
OMAP Applications Processors	www.ti.com/omap
Wireless Connectivity	www.ti.com/wirelessconnectivity

Applications

Automotive and Transportation	www.ti.com/automotive
Communications and Telecom	www.ti.com/communications
Computers and Peripherals	www.ti.com/computers
Consumer Electronics	www.ti.com/consumer-apps
Energy and Lighting	www.ti.com/energy
Industrial	www.ti.com/industrial
Medical	www.ti.com/medical
Security	www.ti.com/security
Space, Avionics and Defense	www.ti.com/space-avionics-defense
Video and Imaging	www.ti.com/video

TI E2E Community

e2e.ti.com