

# Photoelectrics Through-beam Type PD30CNT15....SA

CARLO GAVAZZI



- Miniature sensor range
- Range: 15 m
- Sensitivity adjustment by potentiometer
- Modulated, infrared light 850 nm
- Supply voltage: 10 to 30 VDC
- Output: 100 mA, NPN or PNP preset
- Make and break switching function
- LED indication for output, stability and power ON
- Protection: Short-circuit, reverse polarity and transients
- Cable and plug versions
- Excellent EMC performance



## Product Description

The PD30CNT15 sensor family comes in a compact 10 x 30 x 20 mm reinforced PMMA/ABS housing. The sensors are useful in applications where high-accuracy detection as well as small size is required. Compact housing and high power LED for excellent performance-size ratio.

The potentiometer function for adjustment of the sensitivity makes the sensors highly flexible. The output type is preset (NPN or PNP), and the output switching function is NO and NC output.

## Ordering Key

PD30CNT15NAM5SA

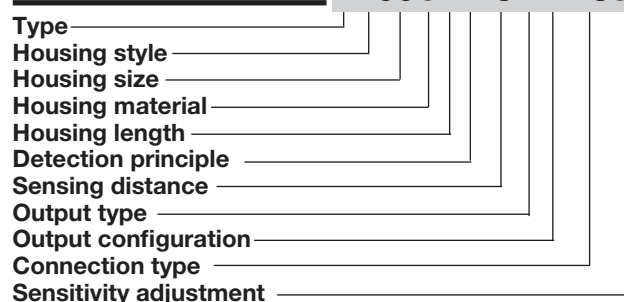

## Type Selection

Housing W x H x D	Range S <sub>n</sub>	Connection	Ordering no. Emitter	Ordering no. NPN Make and break switching	Ordering no. PNP Make and break switching
10 x 30 x 20 mm	15 m	Cable	PD 30 CNT 15	PD 30 CNT 15 NASA	PD 30 CNT 15 PASA
10 x 30 x 20 mm	15 m	Plug	PD 30 CNT 15 M5	PD 30 CNT 15 NAM5SA	PD 30 CNT 15 PAM5SA

**Note:** Emitter, receiver and connector to be ordered separately

## Specifications Receiver EN 60947-5-2

<b>Rated operating distance (S<sub>n</sub>)</b> PD30CNT emitter	≤ 15 m	<b>OFF-state current (I<sub>r</sub>)</b>	≤ 100 μA
<b>Adjustment range</b>	3 to 15 m	<b>Voltage drop (U<sub>d</sub>)</b>	≤ 2 VDC @ I <sub>e</sub> max
<b>Blind zone</b> PD30CNT emitter	None	<b>Protection</b>	Short-circuit, reverse polarity and transients
<b>Sensitivity</b> Electrical adjustment Mechanical adjustment	210° 240°	<b>Ambient light</b>	≤ 10,000 lux
<b>Temperature drift</b>	≤ 0.2%/°C	<b>Operating frequency (f)</b>	≤ 500 Hz
<b>Hysteresis (H)</b>	5% to 20%	<b>Response time</b> OFF-ON (t <sub>ON</sub> ) ON-OFF (t <sub>OFF</sub> )	≤ 1 ms ≤ 1 ms
<b>Rated operational volt. (U<sub>B</sub>)</b>	10 to 30 VDC (ripple included)	<b>Power ON delay (t<sub>v</sub>)</b>	≤ 200 ms
<b>Ripple (U<sub>ripple</sub>)</b>	≤ 10%	<b>Output function</b> Open collector	NPN or PNP by sensor type
<b>Output current</b> Continuous (I <sub>a</sub> ) Short-time (I)	≤ 100 mA ≤ 100 mA (max. load capacity 100 nF)	<b>Output switching function</b>	N.O. and N.C.
<b>No load supply current (I<sub>o</sub>)</b>	≤ 20 mA @ U <sub>B</sub> max	<b>Indication</b> Output ON  Power ON	LED, yellow Signal stability ON and LED, green. See curve for condition of stability
<b>Minimum operational current (I<sub>m</sub>)</b>	≤ 0.5 mA		



## Specifications Emitter EN 60947-5-2

<b>Rated operational volt. (<math>U_B</math>)</b>	10 to 30 VDC (ripple included)	<b>Light spot</b>	110 mm @ 1.5 meters distance
<b>Ripple (<math>U_{rpp}</math>)</b>	$\leq 10\%$	<b>Power ON delay (<math>t_v</math>)</b>	$\leq 200$ ms
<b>No load supply current (<math>I_o</math>)</b>	$\leq 25$ mA @ $U_B$ max	<b>Protection</b>	Reverse polarity and transients
<b>Light source</b>	LED, 850 nm	<b>Indication</b>	LED, green
<b>Light type</b>	Infrared, modulated	Power ON	
<b>Emitter angle</b>	$\pm 2^\circ$ @ half sensing distance		

## General Specifications EN 60947-5-2

<b>Environment</b>		<b>Housing material</b>	
Installation category	III (IEC 60664/60664A; 60947-1)	Body	ABS Light Grey
Pollution degree	3 (IEC 60664/60664A; 60947-1)	Frontglas	PMMA Red
Degree of protection	IP 67 (IEC 60529; 60947-1)	Trimmer shaft	POM Dark Grey
<b>Ambient temperature</b>		<b>Connection</b>	
Operating	-25° to +60°C (-13° to +140°F)	Cable	PVC, black, 2 m 4 x 0.14 mm <sup>2</sup> , $\varnothing = 3.3$ mm
Storage	-40° to +70°C (-40° to +158°F)	Plug	M8, 4-pin (CON. 54-series)
<b>Vibration</b>	10 to 150 Hz, 1.0 mm/15 G (IEC 60068-2-6)	<b>Weight</b>	
<b>Shock</b>	30 g / 11ms, 3 pos, 3 neg per axis (IEC 60068-2-6, 60068-2-32)	Cable version	$\leq 50$ g
<b>Rated insulation voltage</b>	$\leq 500$ VAC (rms)	Plug version	$\leq 20$ g
		<b>CE-marking</b>	Yes
		<b>Approvals</b>	cULus (UL508 + CSA)

## Operation Diagram

$T_v$  = Power ON delay

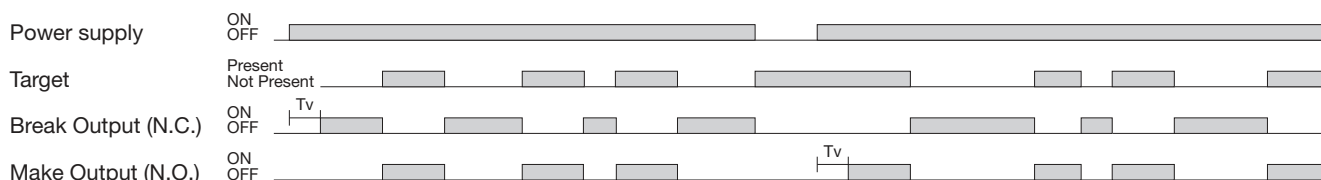

## Signal Stability Indication

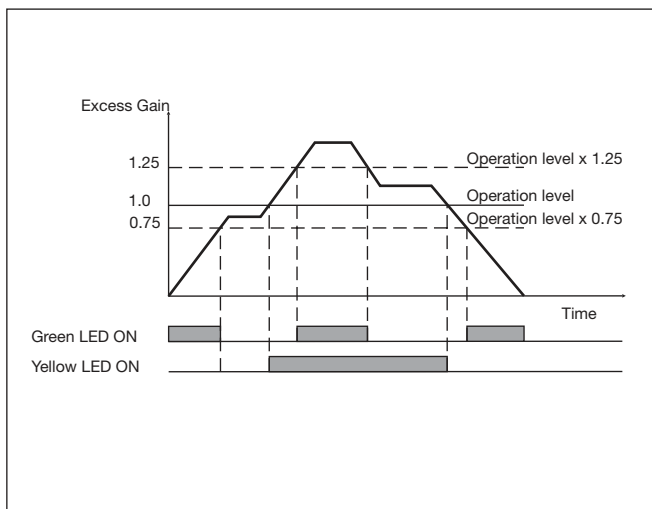

## Wiring Diagrams

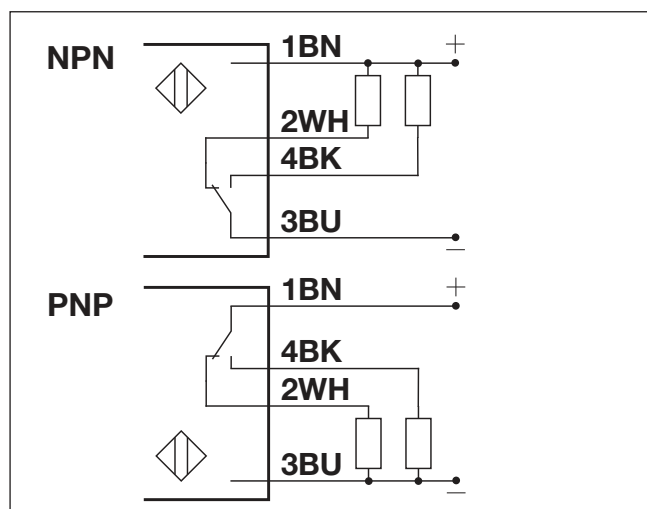

### Detection Diagram

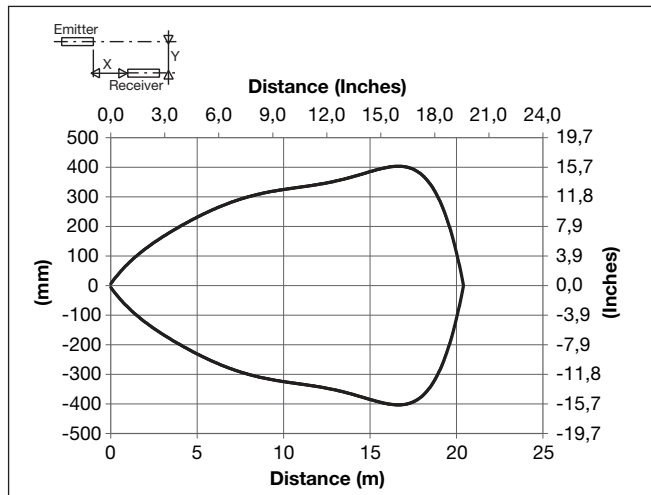

### Excess Gain

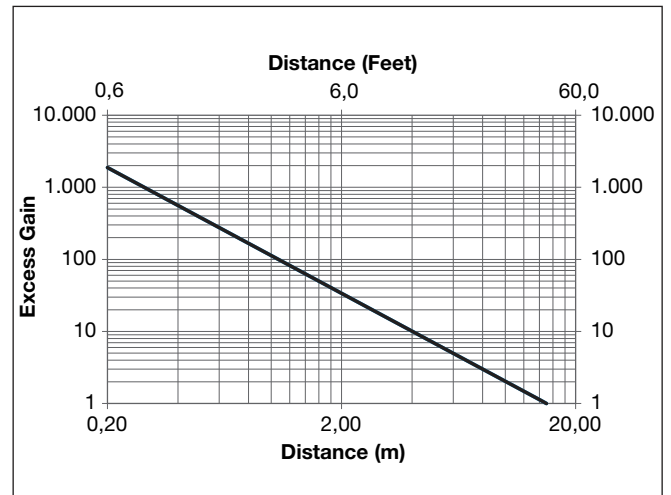

### Dimensions

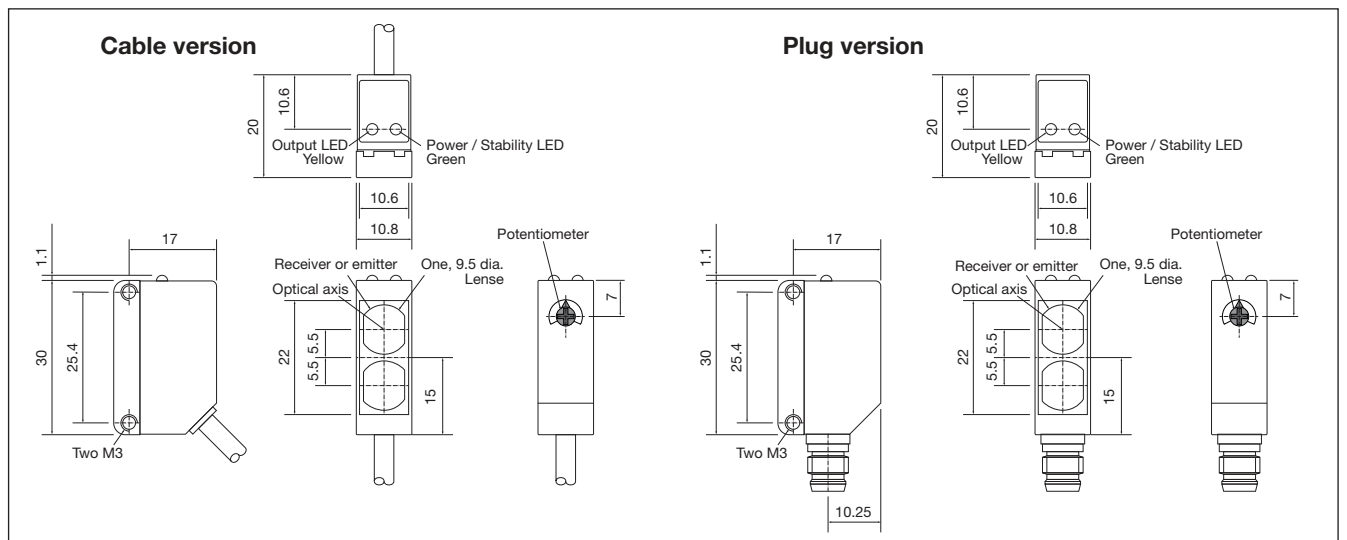

### Installation Hints

<p>To avoid interference from inductive voltage / current peaks, separate the proximity switch cables from any other power cables. E.g. Engine, contactor or solenoid cables</p> <p>Incorrect: Cables bundled together. Correct: Cables separated by &gt; 100 mm.</p>	<p>Relief of the cable strain</p> <p>Incorrect: Cable pulled. Correct: Cable looped back.</p> <p>The cable should not be pulled</p>	<p>Protection of the sensing face</p> <p>Incorrect: Sensing face exposed to a stop. Correct: Sensing face protected.</p> <p>A proximity switch should not serve as mechanical stop</p>	<p>Sensor mounted on a mobile carrier</p> <p>Any repetitive flexing of the cable should be avoided</p>
---	---	--	--

### Accessories

- Mounting bracket APD30-MB1 or APD30-MB2 to be purchased separately.

### Delivery Contents

- Photoelectric switch: PD30CNT15 ...
- Screwdriver (Receiver only)
- **Packaging:** Plastic bag