

SCHOTTKY BARRIER RECTIFIERS

**REVERSE VOLTAGE – 50 to 60 Volts
FORWARD CURRENT – 20 Amperes**

FEATURES

- Metal of silicon rectifier, majority carrier conduction
- Guard ring for transient protection
- Low power loss, high efficiency
- High current capability, low VF
- High surge capability
- Plastic package has UL flammability classification 94V-0
- For use in low voltage, high frequency inverters, free wheeling, and polarity protection applications
- **Lead-Free Finish; RoHS Compliant (Notes 1 & 2)**

MECHANICAL DATA

- Package: ITO-220AB molded plastic
- Polarity: As marked on the body
- Weight: 0.06 ounces, 1.70 grams
- Mounting position: Any
- Max. mounting torque = 0.5 N.m (5.1 Kgf-cm)

ITO-220AB

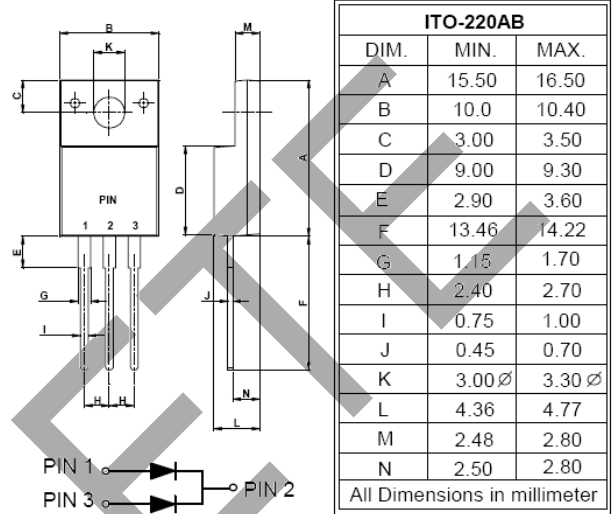

MAXIMUM RATINGS AND ELECTRICAL CHARACTERISTICS

Ratings at 25°C ambient temperature unless otherwise specified.

PARAMETER	SYMBOL	SBF2050CT	SBF2060CT	UNIT
Maximum Repetitive Peak Reverse Voltage	V_{RRM}	50	60	V
Maximum RMS Voltage	V_{RMS}	35	42	V
Maximum DC Blocking Voltage	V_{DC}	50	60	V
Maximum Average Forward Rectified Current(See Fig.1) @TC=85°C	$I_{(AV)}$	20		A
Peak Forward Surge Current 8.3ms single half sine-wave superimposed on rated load	I_{FSM}	225		A
Maximum Forward Voltage at 10A DC (Note 3)	V_F	0.75		V
Maximum DC Reverse Current at Rated DC Blocking Voltage @T _J =25°C @T _J =100°C	I_R	0.1 30		mA
Typical Junction Capacitance per element (Note 4)	C_J	500		pF
Typical thermal resistance _ Junction to Lead (Note 5)	$R_{\theta JC}$	2.5		°C/W
Operating junction temperature range	T_J	-55 to +150		°C
Storage temperature range	T_{STG}	-55 to +150		°C
Dielectric Strength from terminals to case, AC with t=1 minute, RH<30%	V_{dis}	2000		V

Notes:

1. EU Directive 2002/95/EC (RoHS), 2011/65/EU (RoHS 2) & 2015/863/EU (RoHS 3) compliant. All applicable RoHS exemptions applied.
2. See <https://www.diodes.com/quality/lead-free/> for more information about Diodes Incorporated's definitions of Halogen- and Antimony-free, "Green" and Lead-free.
3. 300us Pulse Width, 2% Duty Cycle.
4. Measured at 1.0MHz and applied reverse voltage of 4.0 V DC.
5. Thermal Resistance Junction to Case, device mounted on L200xW200xH5mm_black Aluminum finny heat sink.

RATING AND CHARACTERISTIC CURVES
SBF2060CT

FIG.1- FORWARD CURRENT DERATING CURVE

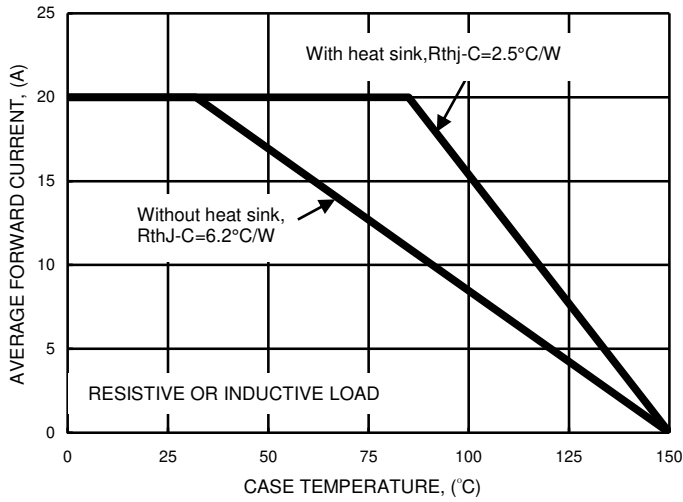

FIG.2- MAXIMUM NON-REPETITIVE SURGE CURRENT

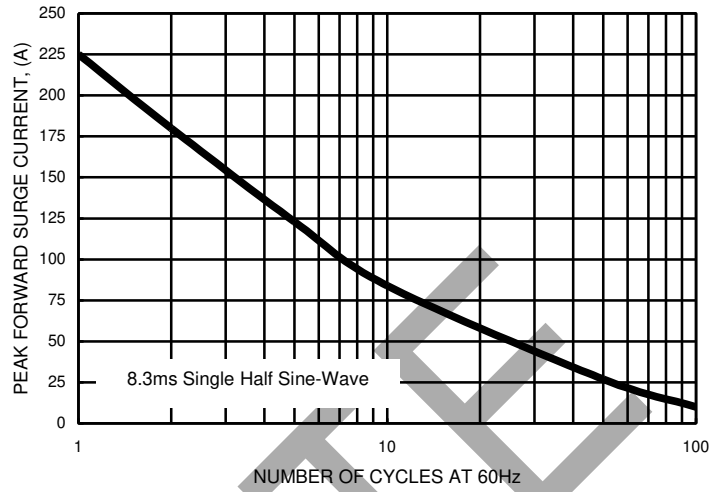

FIG.3- TYPICAL REVERSE CHARACTERISTICS

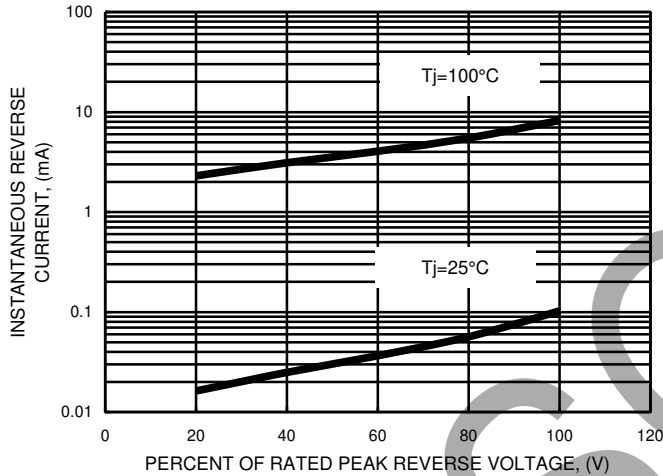

FIG.4- TYPICAL FORWARD CHARACTERISTICS

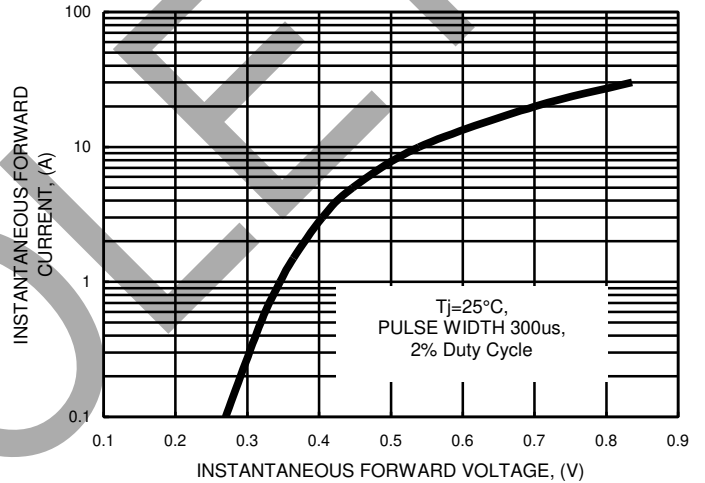

FIG.5- TYPICAL JUNCTION CAPACITANCE

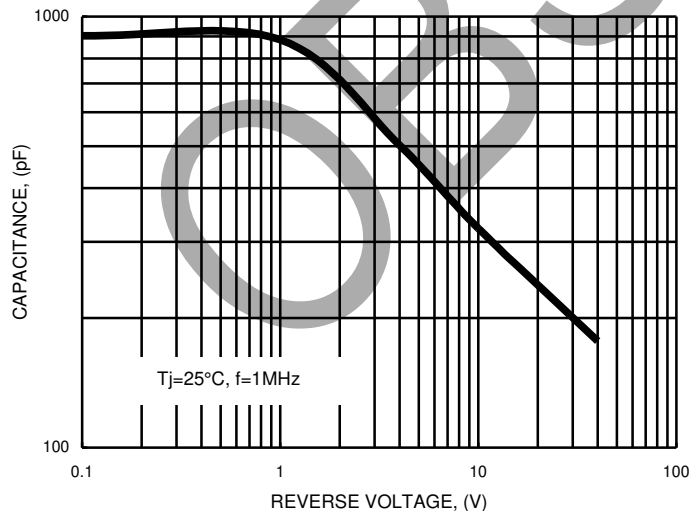
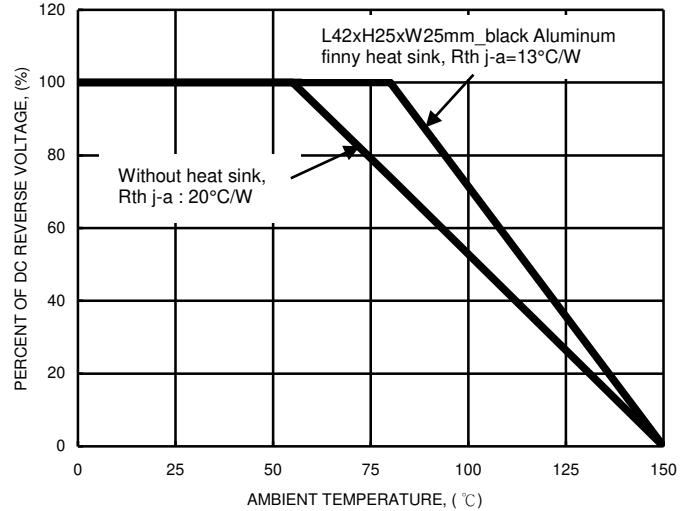

FIG.6- DC REVERSE VOLTAGE DERATING CURVE



Ordering Information:

Part Number	Package	Packing	
		Qty.	Carrier
SBF2060CT	ITO-220AB	50pcs	Tube

Marking Information:

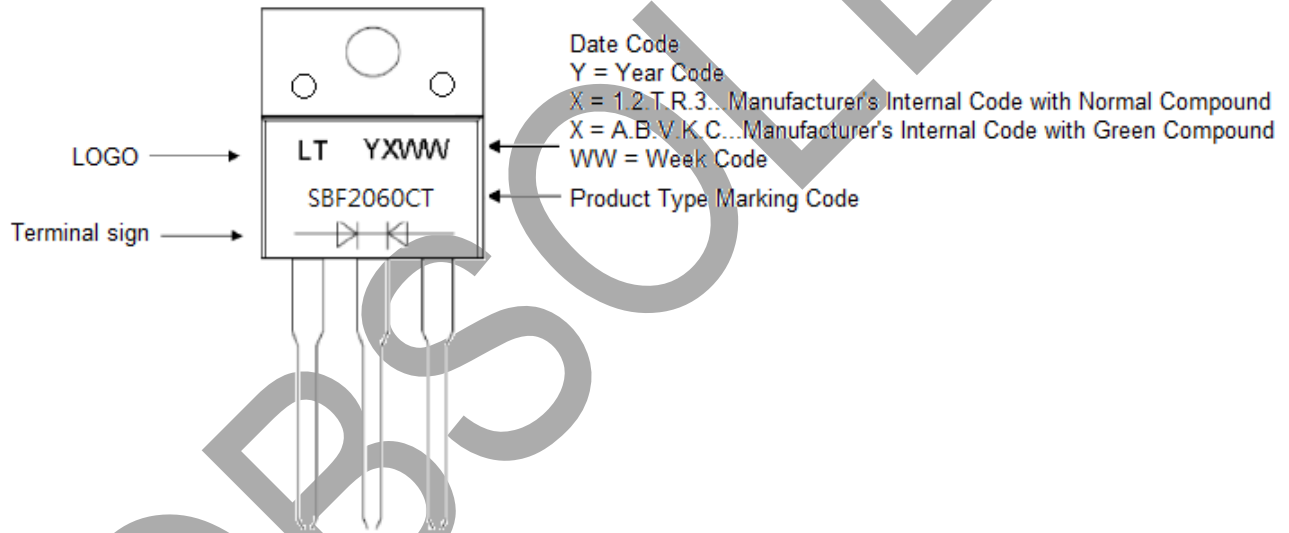

OBSOLETE - PART DISCONTINUED

IMPORTANT NOTICE

1. DIODES INCORPORATED (Diodes) AND ITS SUBSIDIARIES MAKE NO WARRANTY OF ANY KIND, EXPRESS OR IMPLIED, WITH REGARDS TO ANY INFORMATION CONTAINED IN THIS DOCUMENT, INCLUDING, BUT NOT LIMITED TO, THE IMPLIED WARRANTIES OF MERCHANTABILITY, FITNESS FOR A PARTICULAR PURPOSE OR NON-INFRINGEMENT OF THIRD PARTY INTELLECTUAL PROPERTY RIGHTS (AND THEIR EQUIVALENTS UNDER THE LAWS OF ANY JURISDICTION).

2. The Information contained herein is for informational purpose only and is provided only to illustrate the operation of Diodes' products described herein and application examples. Diodes does not assume any liability arising out of the application or use of this document or any product described herein. This document is intended for skilled and technically trained engineering customers and users who design with Diodes' products. Diodes' products may be used to facilitate safety-related applications; however, in all instances customers and users are responsible for (a) selecting the appropriate Diodes products for their applications, (b) evaluating the suitability of Diodes' products for their intended applications, (c) ensuring their applications, which incorporate Diodes' products, comply the applicable legal and regulatory requirements as well as safety and functional-safety related standards, and (d) ensuring they design with appropriate safeguards (including testing, validation, quality control techniques, redundancy, malfunction prevention, and appropriate treatment for aging degradation) to minimize the risks associated with their applications.

3. Diodes assumes no liability for any application-related information, support, assistance or feedback that may be provided by Diodes from time to time. Any customer or user of this document or products described herein will assume all risks and liabilities associated with such use, and will hold Diodes and all companies whose products are represented herein or on Diodes' websites, harmless against all damages and liabilities.

4. Products described herein may be covered by one or more United States, international or foreign patents and pending patent applications. Product names and markings noted herein may also be covered by one or more United States, international or foreign trademarks and trademark applications. Diodes does not convey any license under any of its intellectual property rights or the rights of any third parties (including third parties whose products and services may be described in this document or on Diodes' website) under this document.

5. Diodes' products are provided subject to Diodes' Standard Terms and Conditions of Sale (<https://www.diodes.com/about/company/terms-and-conditions/terms-and-conditions-of-sales/>) or other applicable terms. This document does not alter or expand the applicable warranties provided by Diodes. Diodes does not warrant or accept any liability whatsoever in respect of any products purchased through unauthorized sales channel.

6. Diodes' products and technology may not be used for or incorporated into any products or systems whose manufacture, use or sale is prohibited under any applicable laws and regulations. Should customers or users use Diodes' products in contravention of any applicable laws or regulations, or for any unintended or unauthorized application, customers and users will (a) be solely responsible for any damages, losses or penalties arising in connection therewith or as a result thereof, and (b) indemnify and hold Diodes and its representatives and agents harmless against any and all claims, damages, expenses, and attorney fees arising out of, directly or indirectly, any claim relating to any noncompliance with the applicable laws and regulations, as well as any unintended or unauthorized application.

7. While efforts have been made to ensure the information contained in this document is accurate, complete and current, it may contain technical inaccuracies, omissions and typographical errors. Diodes does not warrant that information contained in this document is error-free and Diodes is under no obligation to update or otherwise correct this information. Notwithstanding the foregoing, Diodes reserves the right to make modifications, enhancements, improvements, corrections or other changes without further notice to this document and any product described herein. This document is written in English but may be translated into multiple languages for reference. Only the English version of this document is the final and determinative format released by Diodes.

8. Any unauthorized copying, modification, distribution, transmission, display or other use of this document (or any portion hereof) is prohibited. Diodes assumes no responsibility for any losses incurred by the customers or users or any third parties arising from any such unauthorized use.

9. This Notice may be periodically updated with the most recent version available at <https://www.diodes.com/about/company/terms-and-conditions/important-notice>

DIODES is a trademark of Diodes Incorporated in the United States and other countries.
The Diodes logo is a registered trademark of Diodes Incorporated in the United States and other countries.
© 2022 Diodes Incorporated. All Rights Reserved.

www.diodes.com

OBSOLETE - PART DISCONTINUED