

HEAT SINK CLIP W/OUT LIGHT PIPE(1X2 SHOWN)

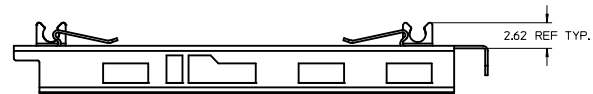
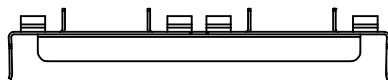
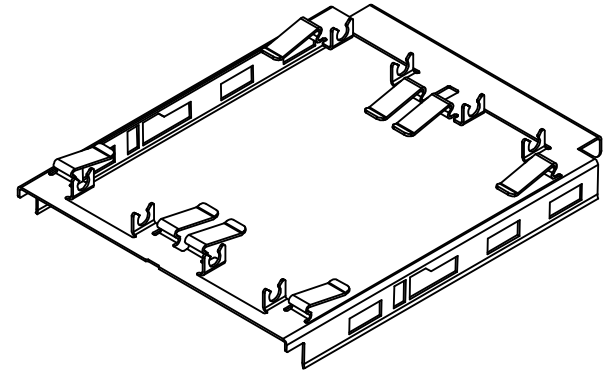
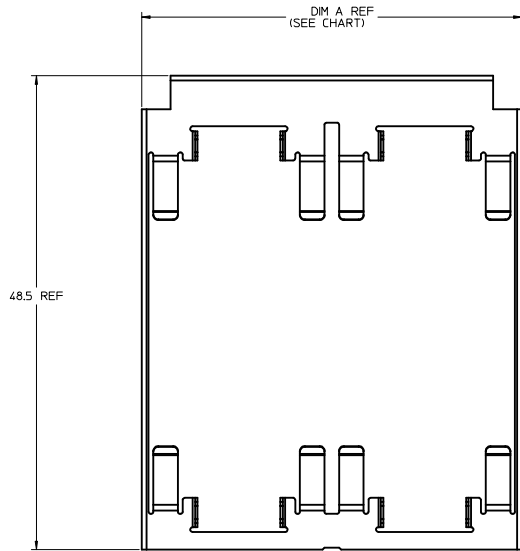

MOLEX P/N	PORT SIZE	DIM A
747830262	1x2	38.9
747830363	1x3	57.9
747830462	1x4	76.9
747830562	1x5	95.9
747830662	1x6	114.9

NOTES:

1. MATERIAL: STAINLESS STEEL
2. PACKAGING: TRAY
3. NO RoHS EXEMPTIONS

SEE REV HISTORY IEC NO: CPG2016-3161 DRAWN BY: CHYD APPR: CHEN08 2016/03/02	QUALITY SYMBOLS	GENERAL TOLERANCES (UNLESS SPECIFIED)	DIMENSION STYLE	SCALE	DESIGN UNITS	THIRD ANGLE PROJECTION	
	▽=0	4 PLACES ±--- ±---	MM ONLY	4:1	METRIC	☉	
	▽=0	3 PLACES ±--- ±---					
	▽=0	2 PLACES ±0.15 ±---					
		1 PLACE ±0.25 ±---					
		0 PLACE ±--- ±---					
		ANGULAR ±1/2°					
		DRAFT WHERE APPLICABLE MUST REMAIN WITHIN DIMENSIONS					
			DRAWN BY: BSWAJA	DATE: 2012/02/09	TITLE:	1X2, 1X3, 1X4, 1X5, 1X6 QSPF+ HEAT SINKS AND CLIP ASSEMBLIES	
			CHECKED BY: KLLLOYD	DATE: 2012/07/11			
			APPROVED BY: KLLLOYD	DATE: 2012/02/16			
			MATERIAL NO. SEE TABLE	DOCUMENT NO. SD-74767-0400			
			SIZE D			SHEET NO. 1 OF 5	
			THIS DRAWING CONTAINS INFORMATION THAT IS PROPRIETARY TO MOLEX INCORPORATED AND SHOULD NOT BE USED WITHOUT WRITTEN PERMISSION				

HEAT SINK CLIP W/ LIGHT PIPE (1X2 SHOWN)

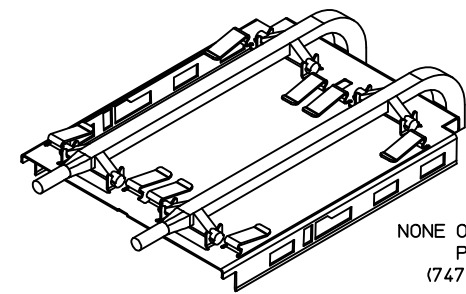
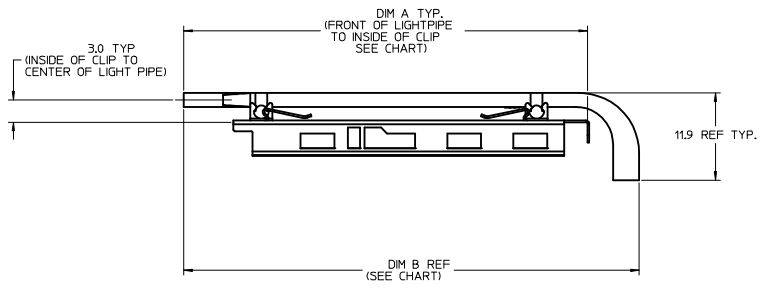
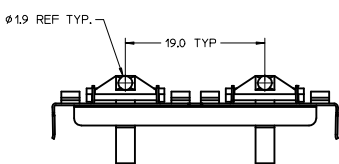

NONE OR SINGLE LIGHT PIPE
PER PORT
(747670403 SHOWN)

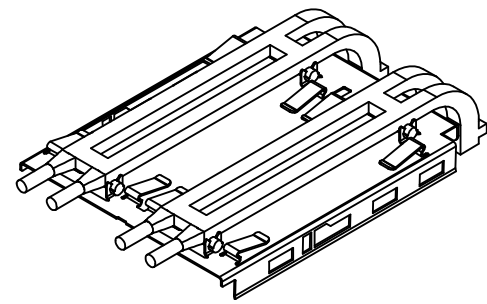
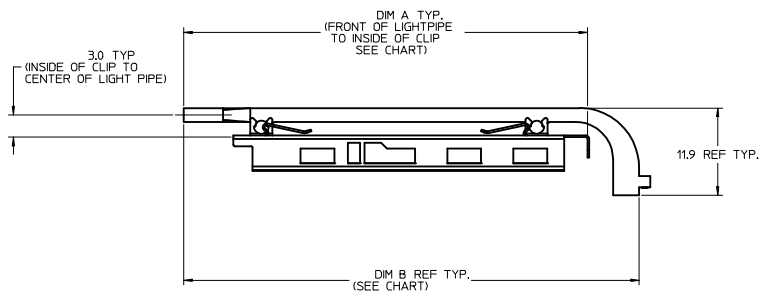
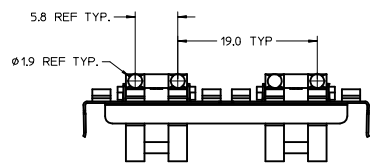

DUAL LIGHT PIPES
PER PORT
(747670404 SHOWN)

NOTES:

1. MATERIALS:
LIGHT PIPE CLIP: STAINLESS STEEL
LIGHT PIPE: POLYCARBONATE (94-V0 RATED)
2. PACKAGE: TRAY
3. RECOMMENDED LED'S INCLUDE THE FOLLOWING MANUFACTURERS:
DIALIGHT: 597-77X1-5XX SERIES
CHICAGO MINIATURE: 7016 SERIES
KINGBRIGHT: APBL3025 SERIES (BICOLOR)
APL3015 SERIES (SINGLE COLOR)
4. NO RoHS EXEMPTIONS

SEE CHART ON SHEET 3 FOR PART NUMBERS AND CHARTED DIMENSIONS

SEE REV HISTORY EC NO: CPG2016-3161 DRAWN: CHENG03 2016/02/25 CHKD: APPR: CHEN08 REV:	QUALITY SYMBOLS	GENERAL TOLERANCES (UNLESS SPECIFIED)	DIMENSION STYLE MM ONLY	SCALE 3:1	DESIGN UNITS METRIC	THIRD ANGLE PROJECTION
	▽=0	4 PLACES ±0.15	mm INCH	DRAWN BY BSWAJA	DATE 2012/02/09	TITLE 1X2, 1X3, 1X4, 1X5, 1X6 QSFP+ HEAT SINKS AND CLIP ASSEMBLIES
	▽=0	3 PLACES ±0.25		CHECKED BY KLOYD	DATE 2012/07/11	molex
	▽=0	2 PLACES ±0.25	ANGULAR ±1/2°	APPROVED BY KLOYD	DATE 2012/02/16	DOCUMENT NO. SD-74767-0400
		DRAFT WHERE APPLICABLE MUST REMAIN WITHIN DIMENSIONS	MATERIAL NO.	SEE SHEET 3		SHEET NO. 2 OF 5
THIS DRAWING CONTAINS INFORMATION THAT IS PROPRIETARY TO MOLEX INCORPORATED AND SHOULD NOT BE USED WITHOUT WRITTEN PERMISSION						

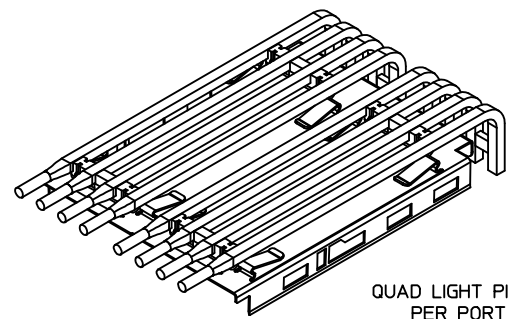
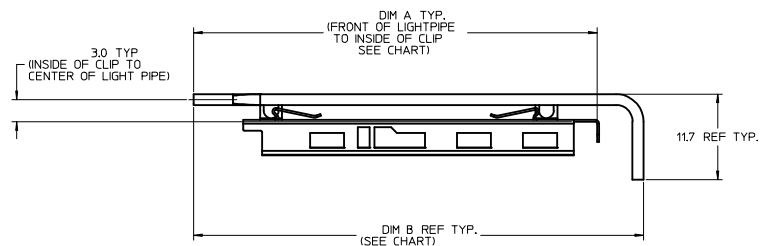
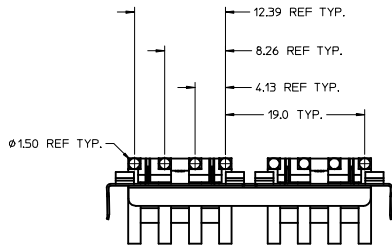

QUAD LIGHT PIPES
PER PORT
(747670406 SHOWN)

NOTES:

- MATERIALS:
LIGHT PIPE CLIP: STAINLESS STEEL
LIGHT PIPE: POLYCARBONATE (94-V0 RATED)
- PACKAGE: TRAY
- RECOMMENDED LED'S INCLUDE THE FOLLOWING MANUFACTURERS:
DIALIGHT: 597-77X1-5XX SERIES
CHICAGO MINIATURE: 7016 SERIES
KINGBRIGHT: APBL3025 SERIES (BICOLOR)
APL3015 SERIES (SINGLE COLOR)
- NO RoHS EXEMPTIONS

MOLEX PN (CLIP & LP ASSEMBLY)					DIM A	DIM B	LIGHT PIPES PER PORT
1x2	1x3	1x4	1x5	1x6			
747670403	747680403	747690403	747700403	747710403	55.0	62.0	NONE OR SINGLE
747670404	747680404	747690404	747700404	747710404	55.0	62.0	DUAL
747670405	N/A	N/A	N/A	N/A	53.2	63.0	
747670406	N/A	N/A	N/A	N/A	55.0	61.3	QUAD

SEE REV HISTORY IEC NO: CPG2016-3161 TDRWNA/CHENG03 2016/02/25 CHYK03 APPR:CHEN08 2016/03/02	QUALITY SYMBOLS	GENERAL TOLERANCES (UNLESS SPECIFIED)	DIMENSION STYLE	SCALE	DESIGN UNITS	THIRD ANGLE PROJECTION
	▽=0	mm INCH	MM ONLY	3:1	METRIC	☉
	▽=0	4 PLACES ± --- ± ---	DRAWN BY DATE			
	▽=0	3 PLACES ± 0.15 ± 0.25	BSWA JA 2012/02/09			
	ANGULAR ±1/2°	DRAFT WHERE APPLICABLE MUST REMAIN WITHIN DIMENSIONS	CHECKED BY DATE			
			KLLOYD 2012/07/11			
			APPROVED BY DATE			
			KLLOYD 2012/02/16			
			MATERIAL NO.	DOCUMENT NO.		
			SEE TABLE	SD-74767-0400		
			SIZE D			
			THIS DRAWING CONTAINS INFORMATION THAT IS PROPRIETARY TO MOLEX INCORPORATED AND SHOULD NOT BE USED WITHOUT WRITTEN PERMISSION			

NONE OR SINGLE LIGHT PIPE
PER PORT
(SAN HEIGHT - 747500314 SHOWN)

HEAT SINK

DUAL LIGHT PIPES
PER PORT
(SAN HEIGHT - 747500308 SHOWN)

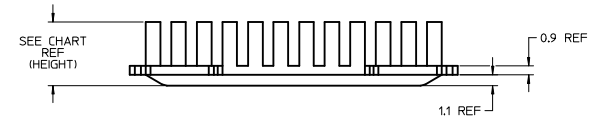
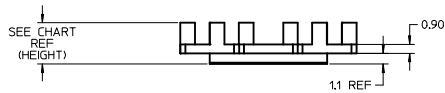
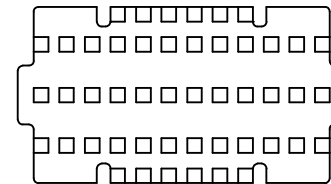
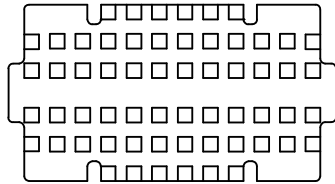
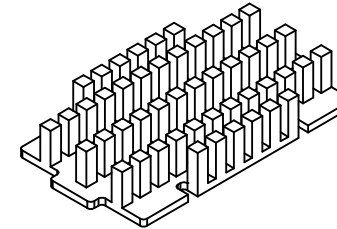
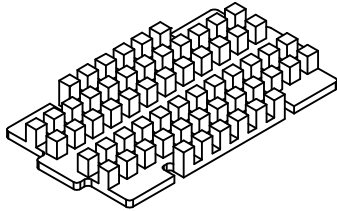

NOTES:

1. MATERIAL:
HEAT SINKS: BLACK ANNOXIDIZED ALUMINUM
2. PACKAGE: TRAY
3. CUSTOM HEATSINKS AVAILABLE UPON REQUEST.
4. NO RoHS EXEMPTIONS

MOLEX P/N		SYSTEM TYPE	HEIGHT (mm)
NONE OR SINGLE LIGHT PIPE PER PORT	DUAL LIGHT PIPES PER PORT		
747500314	747500315	PCI	4.2
-----	747500308	SAN	6.5
747500317	747500318	NET	13.5

SEE REV HISTORY EC NO: CPG2016-3161 DRAWN BY: CHYD APPR: CHEN08 2016/02/25 2016/03/02	QUALITY SYMBOLS	GENERAL TOLERANCES (UNLESS SPECIFIED)	DIMENSION STYLE	SCALE	DESIGN UNITS	THIRD ANGLE PROJECTION
	▽=0	mm INCH	MM ONLY	4:1	METRIC	☑
	▽=0	4 PLACES ± --- ± ---	DRAWN BY: BSWAJA	DATE: 2012/02/09	TITLE: 1X2, 1X3, 1X4, 1X5, 1X6 QSPF+ HEAT SINKS AND CLIP ASSEMBLIES	
	▽=0	3 PLACES ± --- ± ---	CHECKED BY: KLOYD	DATE: 2012/07/11	MATERIAL NO. SEE TABLE	
	2 PLACES ± 0.15 ± ---	APPROVED BY: KLOYD	DATE: 2012/02/16	DOCUMENT NO. SD-74767-0400		SHEET NO. 4 OF 5
	1 PLACE ± 0.25 ± ---	DRAFT WHERE APPLICABLE MUST REMAIN WITHIN DIMENSIONS		THIS DRAWING CONTAINS INFORMATION THAT IS PROPRIETARY TO MOLEX INCORPORATED AND SHOULD NOT BE USED WITHOUT WRITTEN PERMISSION		

