

FAN7080_GF085 Half Bridge Gate Driver

Features

- Qualified to AEC Q100
- Floating channel designed for bootstrap operation fully operational to + 600V
- Tolerance to negative transient voltage on VS pin
- VS-pin dv/dt immune.
- Gate drive supply range from 5.5V to 20V
- Under-voltage lockout
- CMOS Schmitt-triggered inputs with pull-down
- High side output in phase with input
- IN input is 3.3V/5V logic compatible and available on 15V input
- Matched propagation delay for both channels
- Dead time adjustable

Typical Applications

- Junction Box
- Half and full bridge application in the motor drive system



For Fairchild's definition of "green" Eco Status, please visit:
http://www.fairchildsemi.com/company/green/rohs_green.html

Description

The FAN7080_GF085 is a half-bridge gate drive IC with reset input and adjustable dead time control. It is designed for high voltage and high speed driving of MOSFET or IGBT, which operates up to 600V. Fairchild's high-voltage process and common-mode noise cancellation technique provide stable operation in the high side driver under high-dV/dt noise circumstances. An advanced level-shift circuit allows high-side gate driver operation up to VS=-5V (typical) at VBS=15V. Logic input is compatible with standard CMOS outputs. The UVLO circuits for both channels prevent from malfunction when VCC and VBS are lower than the specified threshold voltage. Combined pin function for dead time adjustment and reset shutdown make this IC packaged with space saving SOIC-8 Package. Minimum source and sink current capability of output driver is 250mA and 500mA respectively, which is suitable for junction box application and half and full bridge application in the motor drive system.

SOIC-8



Ordering Information

Device	Package	Operating Temp.
FAN7080M	SOIC-8	-40 °C ~ 125 °C
FAN7080MX	SOIC-8	-40 °C ~ 125 °C

X : Tape & Reel type

Block Diagrams

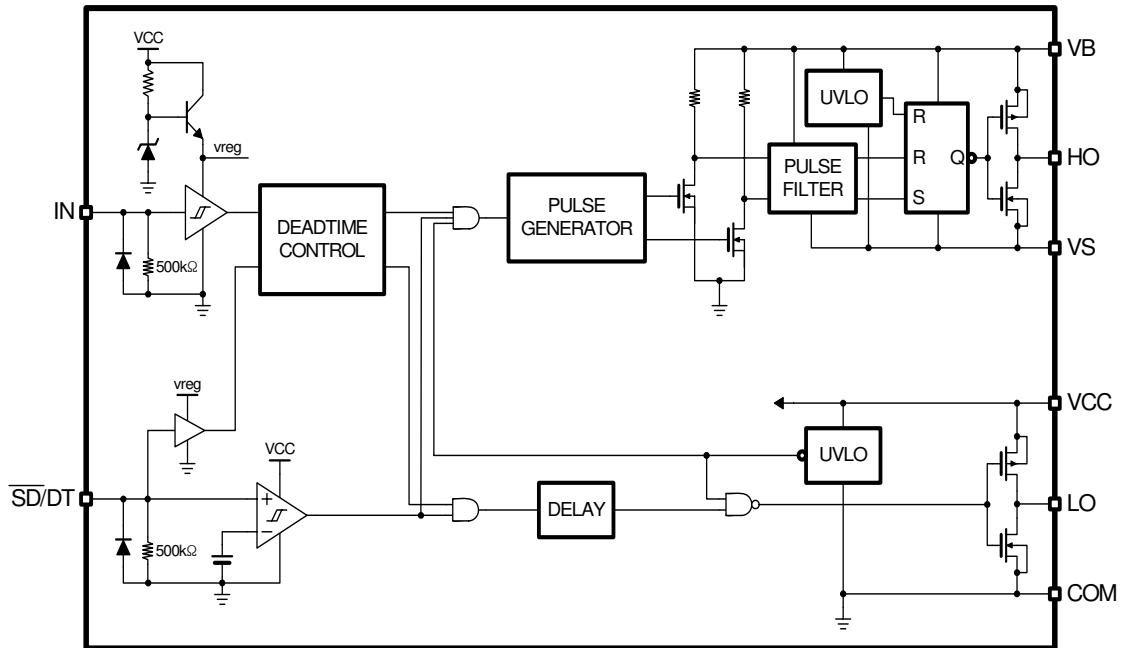

Pin Assignments

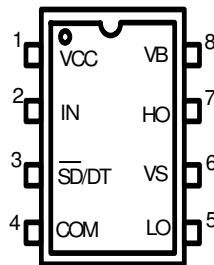

Pin Definitions

Pine Number	Pin Name	I/O	Pin Function Description
1	VCC	P	Driver supply voltage
2	IN	I	Logic input for high and low side gate drive output
3	SD/DT	I	Shut down input and dead time setting
4	COM	P	Ground
5	LO	A	Low side gate drive output for MOSFET Gate connection
6	VS	A	High side floating offset for MOSFET Source connection
7	HO	A	High side drive output for MOSFET Gate connection
8	VB	P	Driver output stage supply

Absolute Maximum Ratings

Absolute Maximum Ratings indicate sustained limits beyond which damage to the device may occur. All voltage parameters are absolute voltages referenced to COM.

Parameter	Symbol	Min.	Max.	Unit
High side floating supply offset voltage	VS	VB-25	VB+0.3	V
High side floating supply voltage	VB	-0.3	625	V
High side floating output voltage	VHO	Vs-0.3	VB+0.3	V
Low side output voltage	VLO	-0.3	VCC + 0.3	V
Supply voltage	VCC	-0.3	25	V
Input voltage for $\overline{\text{IN}}$	VIN	-0.3	VCC+0.3	V
Input injection current. Full function, no latch up;(Guaranteed by design). Test at 10V and 17V on Eng.Samples	IIN	-	+1	mA
Power Dissipation	Pd		0.625	W
Thermal resistance, junction to ambient	Rthja		200	°C/W
Electrostatic discharge voltage (Human Body Model)	VESD	1K		V
Charge device model	VCDM	500		V
Junction Temperature	Tj		150	°C
Storage Temperature	Ts	-55	150	°C

Note: 1) The thermal resistance and power dissipation rating are measured below conditions;

JESD51-2: Integrated Circuit Thermal Test Method Environmental Conditions - Natural convection(StillAir)

JESD51-3 : Low Effective Thermal Conductivity Test Board for Leaded Surface Mount Package

Recommended Operating Conditions

For proper operation the device should be used within the recommended conditions.

Parameter	Symbol	Min.	Max.	Unit
High side floating supply voltage(DC) Transient:-10V@ 0.1 us	VB ¹⁾	VS + 6	VS + 20	V
High side floating supply offset voltage(DC) Transient: -25V(max) @0.1us @VBS<25V	VS	-5	600	V
High side floating output voltage	VHO	Vs	VB	V
Low side output voltage	VLO	0	VCC	V
Allowable offset voltage Slew Rate ²⁾	dv/dt	-	50	V/ns
Supply voltage for logic part	VCC	5.5	20	V
Logic input voltage	VIN	0	VCC	V
Switching Frequency ³⁾	Fs		200	KHz
Ambient Temperature	Ta	-40	125	°C

Note: 1) The Vs offset is tested with all supplies biased at 15V differential.

2) Guaranteed by design.

3) When VDT= 1.2V.

Statics Electrical Characteristics

Unless otherwise specified, $-40^{\circ}\text{C} \leq T_a \leq 125^{\circ}\text{C}$, $V_{CC} = 15\text{V}$, $V_{BS} = 15\text{V}$, $V_S = 0\text{V}$, $C_L = 1\text{nF}$.

Parameter	Symbol	Conditions	Min.	Typ.	Max.	Unit
Vcc and VBS supply Characteristics						
VCC and VBS supply under voltage positive going threshold	VCCUV+ VBSUV+	-	-	4.2	5.5	V
VCC and VBS supply under voltage negative going threshold	VCCUV- VBSUV-	-	2.8	3.6	-	V
VCC and VBS supply under voltage hysteresis	VCCUVH VBSUVH	-	0.2	0.6	-	V
Under voltage lockout response time	tduvcc tduvbs	VCC: 6V-->2.5V or 2.5V-->6V VBS: 6V-->2.5V or 2.5V-->6V	0.5 0.5	- -	20 20	us us
Offset supply leakage current	ILK	VB=VS=600V	-	20	50	uA
Quiescent VBS supply current	IQBS	VIN=0 OR 5V, VS _{DT} = 1.2V	20	75	150	uA
Quiescent Vcc supply current	IQCC	VIN=0 OR 5, VS _{DT} = 1.2V	-	350	1000	uA
Input Characteristics						
High logic level input voltage	VIH		2.7	-	-	V
Low logic level input voltage	VIL		-	-	0.8	V
High logic level input bias current for IN	IIN+	VIN=5V	-	10	50	uA
Low logic level input bias current for IN	IIN-	VIN=0V	-	0	2	uA
VS _{DT} dead time setting range	VDT		1.2	-	5	V
VS _{DT} shutdown threshold voltage	VSD		-	0.8	1.2	V
High logic level resistance for $\overline{\text{SD}}/\text{DT}$	RS _{DT}	VSD _{DT} =5V	100	500	1100	K Ω
Low logic level input bias current for $\overline{\text{SD}}/\text{DT}$	IS _{DT} -	VSD _{DT} =0V	-	1	2	uA
Output characteristics						
High level output voltage, VCC-VHO	VOH(HO)	IO=0	-	-	0.1	V
Low level output voltage, VHO	VOL(HO)	IO=0	-	-	0.1	V
Output high short circuit pulse current	IO+(HO)		250	300	-	mA
Output low short circuit pulse current	IO-(HO)		500	600	-	mA
Equivalent output resistance	ROP(HO)		-	-	60	Ω
	RON(HO)		-	-	30	Ω
High level output voltage, VB-VLO	VOH(LO)	IO=0	-	-	0.1	V
Low level output voltage, VLO	VOL(LO)	IO=0	-	-	0.1	V
Output high short circuit pulse current	IO+(LO)		250	-	-	mA
Output low short circuit pulse current	IO-(LO)		500	-	-	mA
Equivalent output resistance	ROP(LO)		-	-	60	Ω
	RON(LO)		-	-	30	Ω

Dynamic Electrical Characteristics

Unless otherwise specified, $-40^{\circ}\text{C} \leq T_a \leq 125^{\circ}\text{C}$, $V_{CC} = 15\text{V}$, $V_{BS} = 15\text{V}$, $V_S = 0\text{V}$, $C_L = 1\text{nF}$.

Parameter	Symbol	Conditions	Min.	Typ.	Max.	Unit
Turn-on propagation delay	ton	$V_S=0\text{V}$	-	750	1500	ns
Turn-off propagation delay	toff	$V_S=0\text{V}$	-	130	250	ns
Turn -on rising time	tr	-	-	40	150	ns
Turn -off falling time	tf	-	-	25	400	ns
Dead time, LS turn-off to HS turn-on and HS turn-on to LS turn-off	DT	$V_{IN}=0$ or 5V @ $V_{DT}=1.2\text{V}$ $V_{IN}=0$ or 5V @ $V_{DT}=3.3\text{V}$	250 1600	650 2100	1200 2600	ns
Dead time matching time	MDT	$DT1 - DT2$ @ $V_{DT}=1.2\text{V}$ $DT1 - DT2$ @ $V_{DT}=3.3\text{V}$	-	35 -	110 300	ns
Delay Matching, HS and LS turn-on	MTON	$V_{DT}=1.2\text{V}$	-	25	110	ns
Delay Matching, HS and LS turn-off	MTOFF	$V_{DT}=1.2\text{V}$	-	15	60	ns
Shutdown propagation delay	Tsd		-	180	330	ns
Switching Frequency	Fs1	$V_{CC}=V_{BS}=20\text{V}$	-	-	200	KHz
	Fs2	$V_{CC}=V_{BS}=5.5\text{V}$	-	-	200	KHZ

Typical Application Circuit

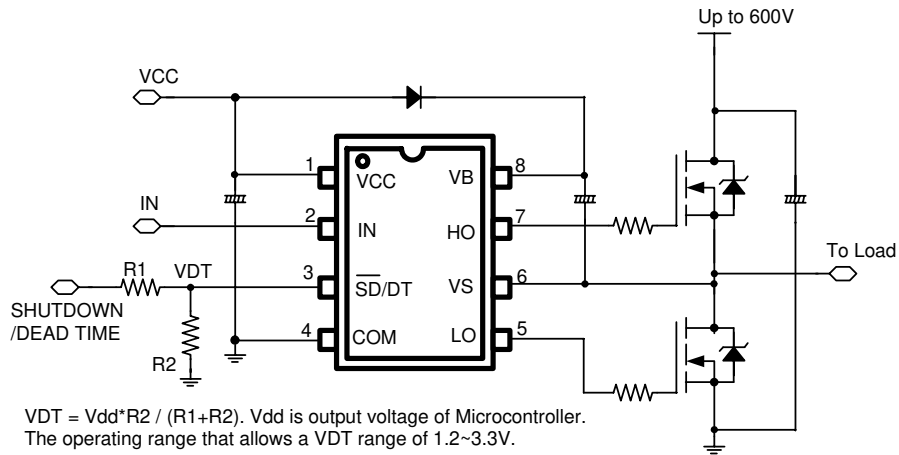

$VDT = Vdd \cdot R2 / (R1 + R2)$. Vdd is output voltage of Microcontroller.
 The operating range that allows a VDT range of 1.2~3.3V.
 When pulled lower than VDT [Typ. 0.5V] the device is shutdown.
 Care must be taken to avoid below threshold spikes on pin 3 that can cause undesired shut down of the IC.
 For this reason the connection of the components between pin 3 and ground has to be as short as possible.
 And a capacitor (Typ 0.02uF) between pin3 and COM can prevent this spike. This pin can not be left floating for the same reason.

Typical Waveforms

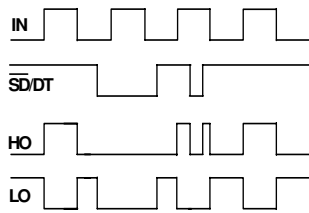

Figure 1. Input/output Timing Diagram

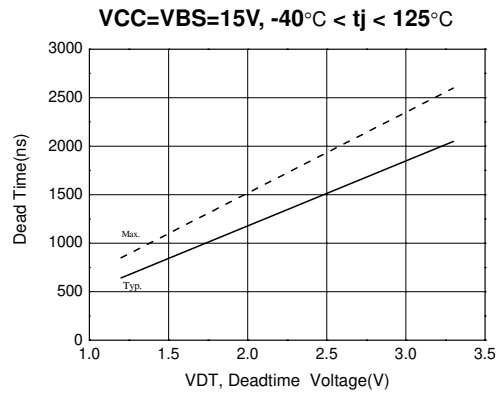

Figure 2. Dead Time VS VDT

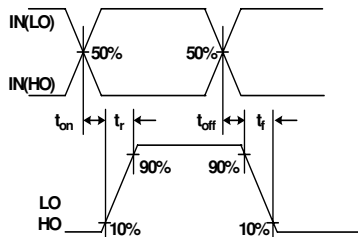

Figure 3. Switching Time Waveform Definitions

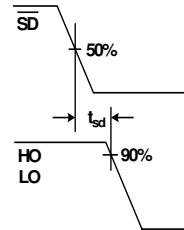

Figure 4. Shutdown Waveform Definitions

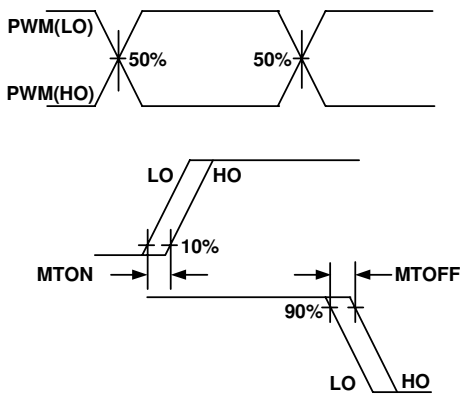

Figure 5. Delay Matching Waveform Definitions

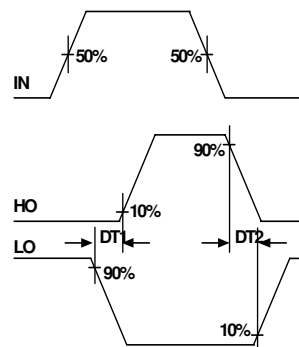

Figure 6. Dead Time Waveform Definitions

Performance Graphs (This performance graphs based on ambient temperature -40°C ~125°C)

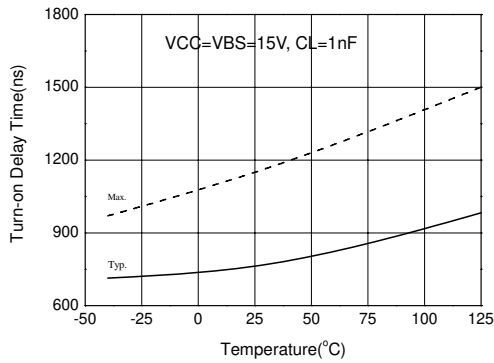

Figure 7a. Turn-On Delay Time of HO vs VBS Temperature

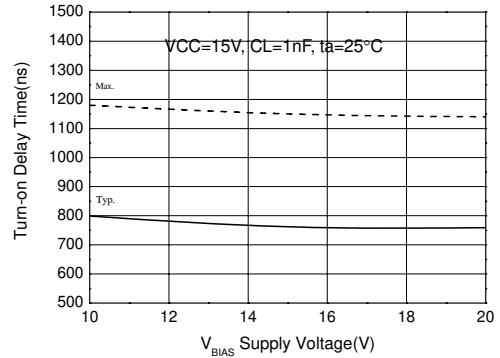

Figure 7b. Turn-On Delay Time of HO vs VBS Supply Voltage

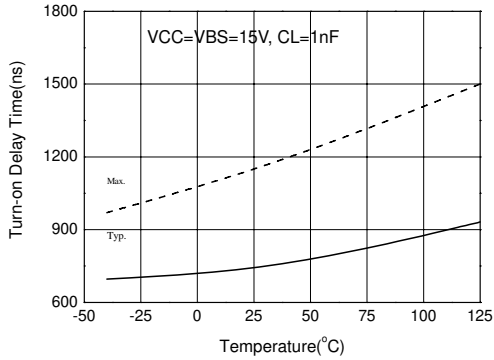

Figure 8a. Turn-On Delay Time of LO vs Temperature

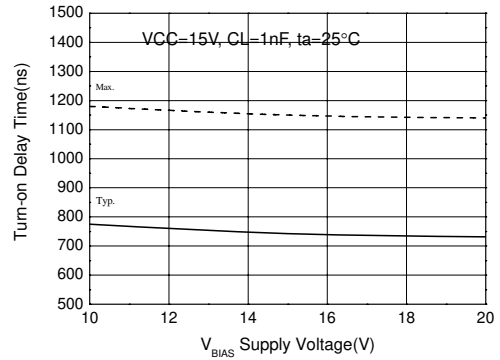

Figure 8b. Turn-On Delay Time vs of LO VBS Supply Voltage

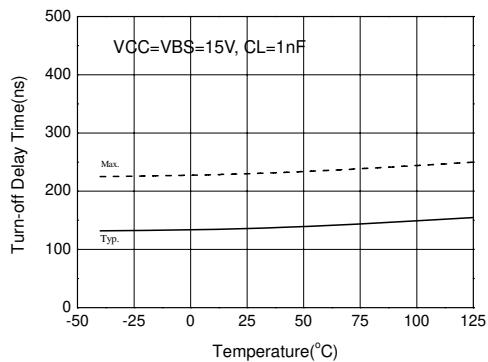

Figure 9a. Turn-Off Delay Time of HO vs Temperature

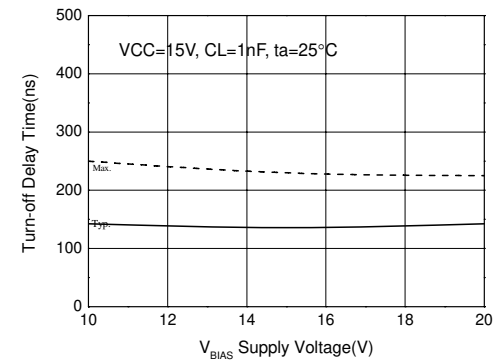

Figure 9b. Turn-Off Delay Time of HO vs VBS Supply Voltage

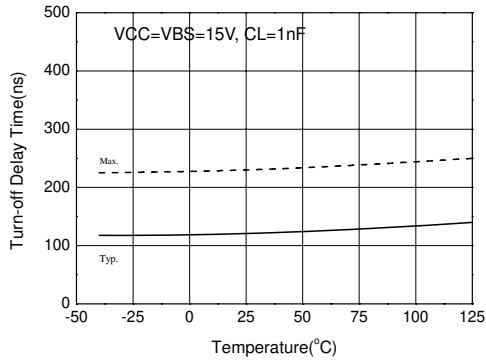

Figure 10a. Turn-Off Delay Time of LO vs Temperature

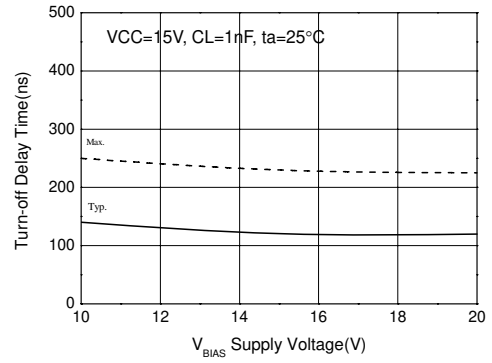

Figure 10b. Turn-Off Delay Time of LO vs VBS Supply Voltage

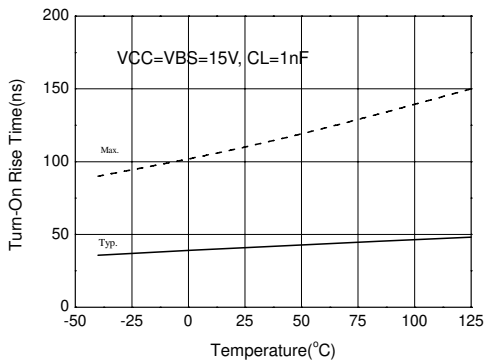

Figure 11a. Turn-On Rise Time of HO vs Temperature

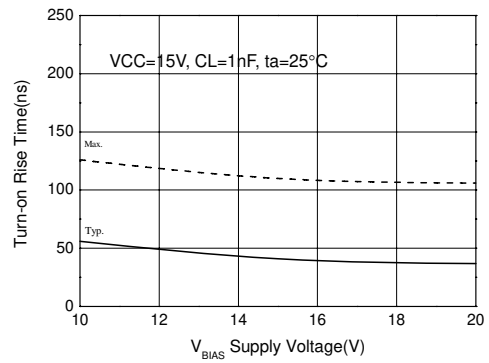

Figure 11b. Turn-On Rise Time vs of HO VBS Supply Voltage

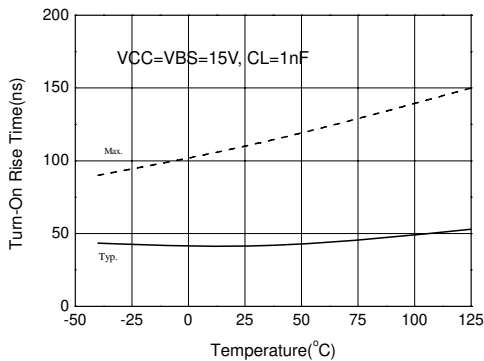

Figure 12a. Turn-On Rise Time of LO vs Temperature

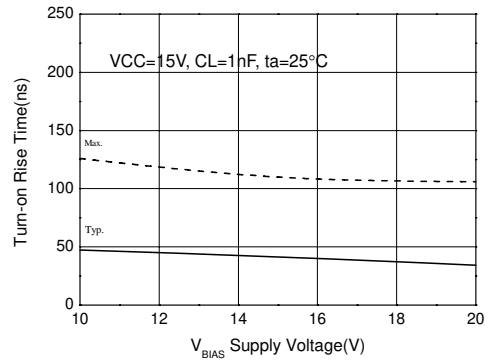

Figure 12b. Turn-On Rise Time of LO vs VBS Supply Voltage

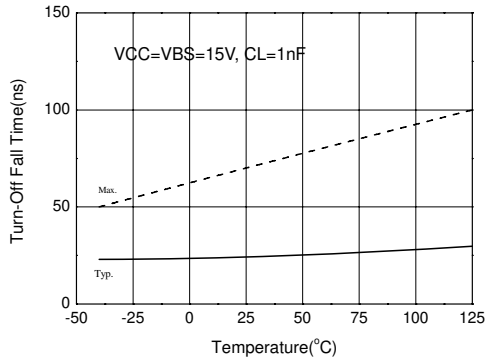

Figure 13a. Turn-Off Fall Time of HO vs Temperature

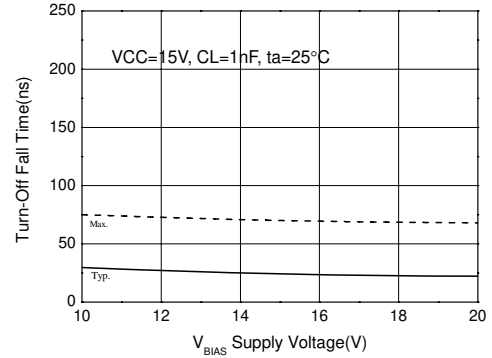

Figure 13b. Turn-Off Fall Time of HO vs VBS Supply Voltage

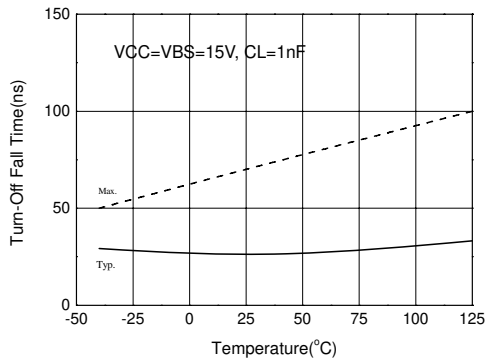

Figure 14a. Turn-Off Fall Time of LO vs Temperature

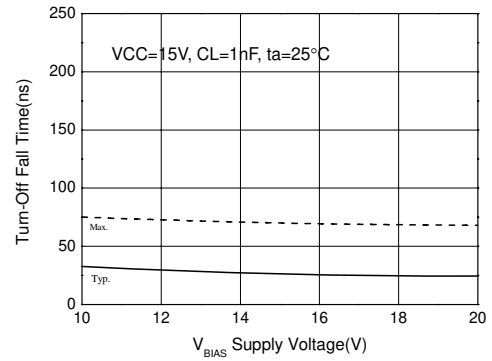

Figure 14b. Turn-Off Fall Time of LO vs BS Supply Voltage

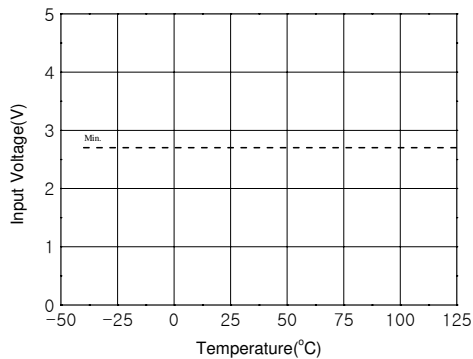

Figure 15a. Logic 0 Input Voltage vs Temperature

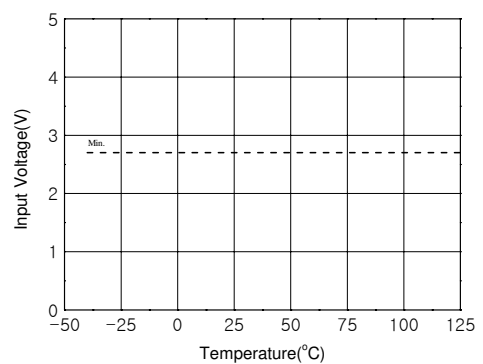

Figure 15b. Logic 1 Input Voltage vs Temperature

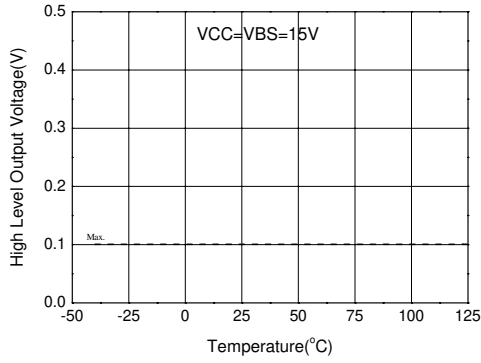

Figure 16a. High Level Output of HO vs Temperature

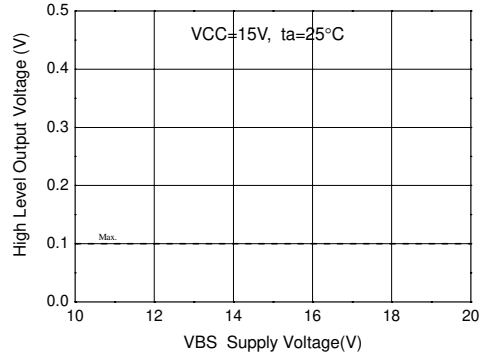

Figure 16b. High Level Output of HO vs VBS Supply Voltage

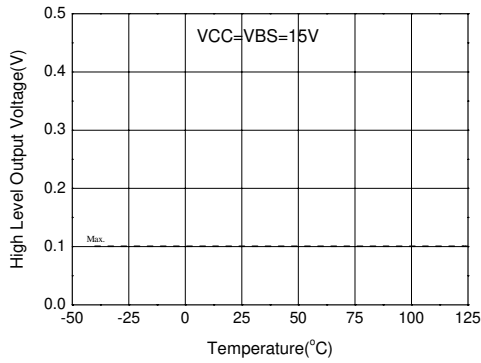

Figure 17a. High Level Output of LO vs Temperature

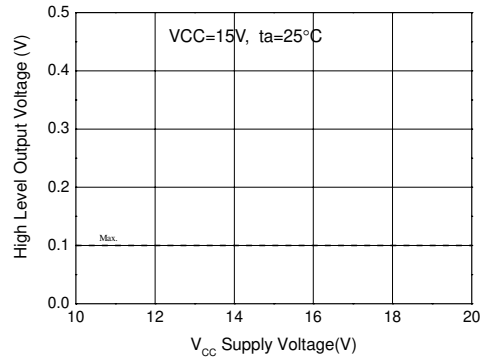

Figure 17b. High Level Output of LO vs VCC Supply Voltage

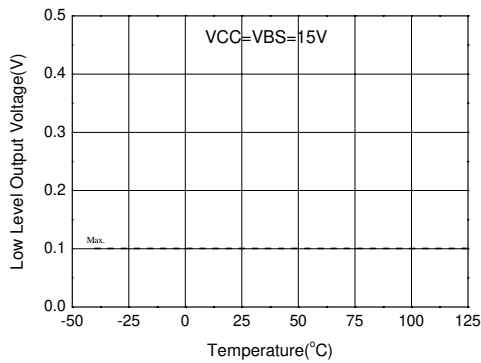

Figure 18a. Low Level Output of HO vs Temperature

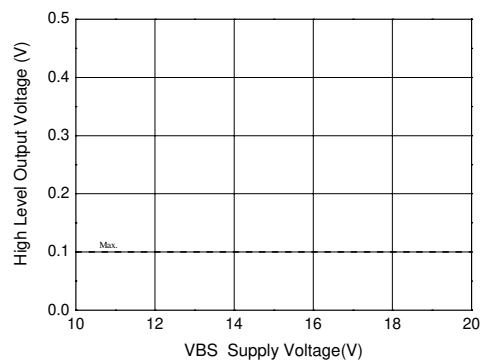

Figure 18b. Low Level Output of HO vs VBS Supply Voltage

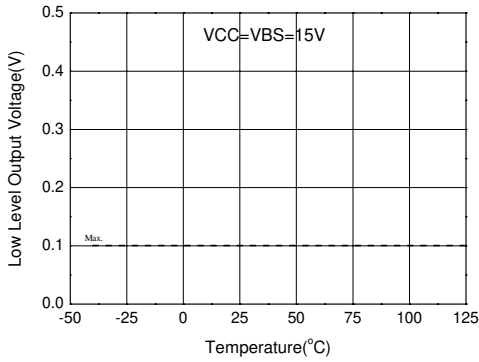

Figure 19a. Low Level Output of LO vs Temperature

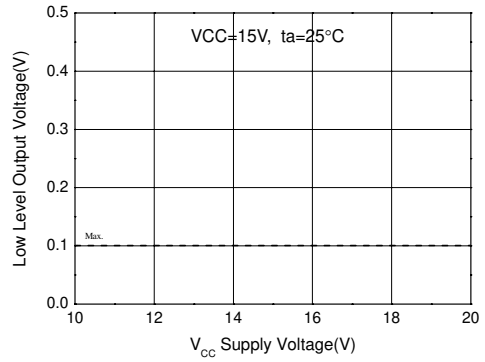

Figure 19b. Low Level Output of LO vs VCC Supply Voltage

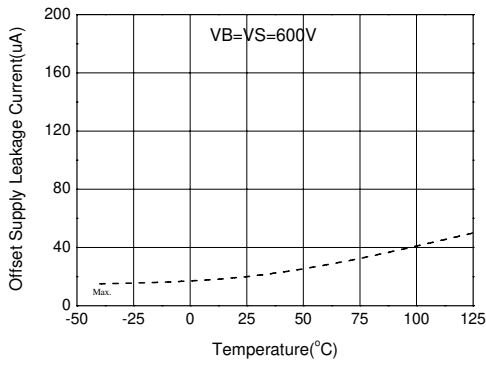

Figure 20a. Offset Supply leakage Current vs Temperature

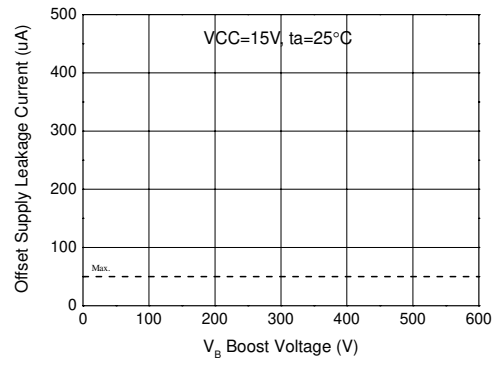

Figure 20b. Offset Supply leakage Current vs VB Boost Voltage

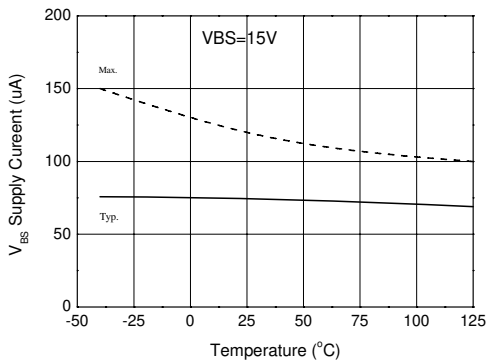

Figure 21. VBS Supply Current vs Temperature

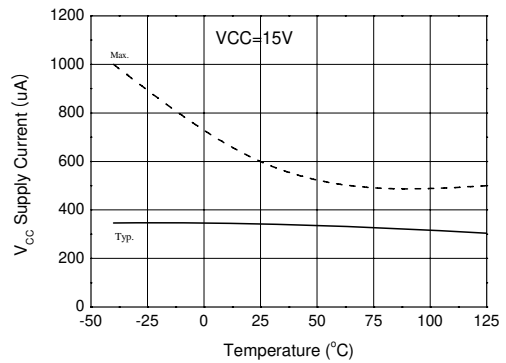

Figure 22. VCC Supply Current vs Temperature

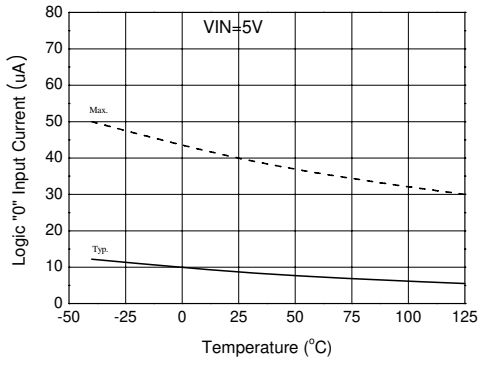

Figure 23a. Logic 1 Input Current vs Temperature

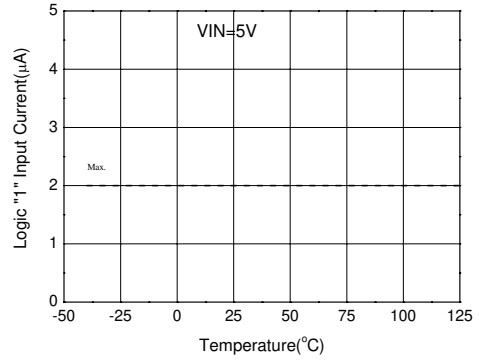

Figure 23b. Logic 0 Input Current vs Temperature

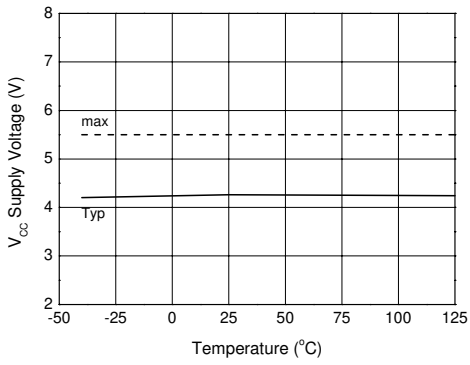

Figure 24a. VCC UnderVoltage Threshold (+) vs Temperature

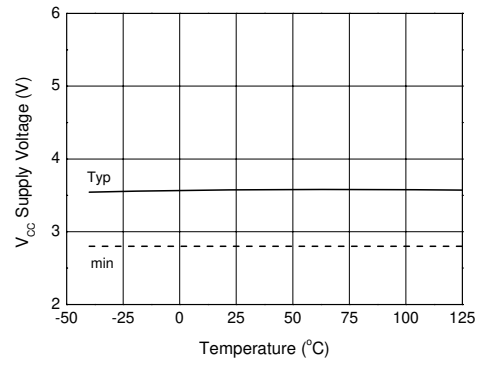

Figure 24b. VCC UnderVoltage Threshold(-) vs Temperature

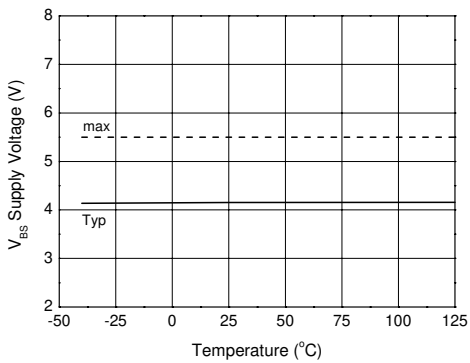

Figure 25a. VBS UnderVoltage Threshold (+) vs Temperature

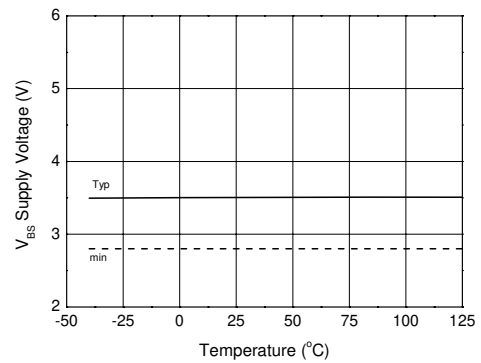

Figure 25b. VBS UnderVoltage Threshold(-) vs Temperature

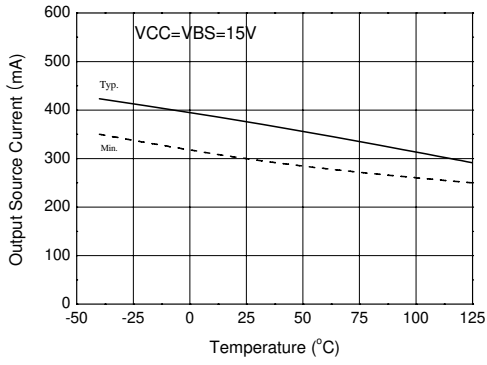

Figure 26a. Output Source Current of HO vs Temperature

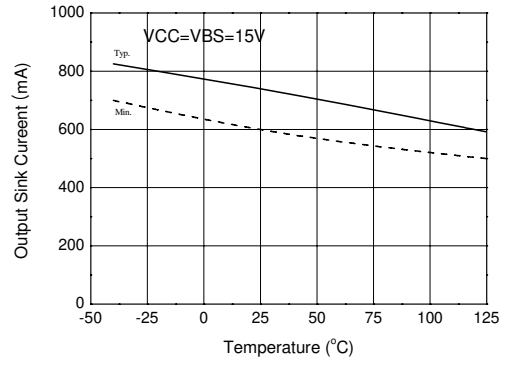

Figure 26b. Output Sink Current of HO vs Temperature

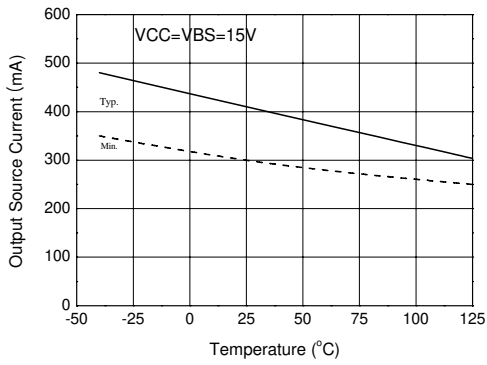

Figure 27a. Output Source Current of LO vs Temperature

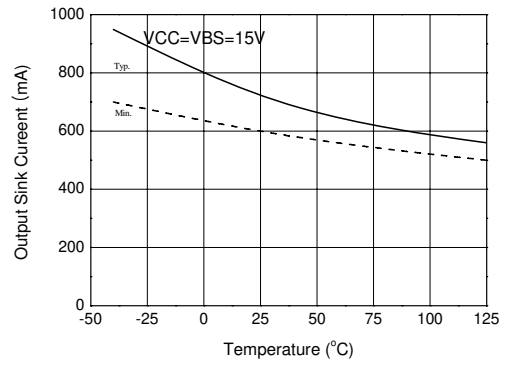

Figure 27b. Output Sink Current of LO vs Temperature

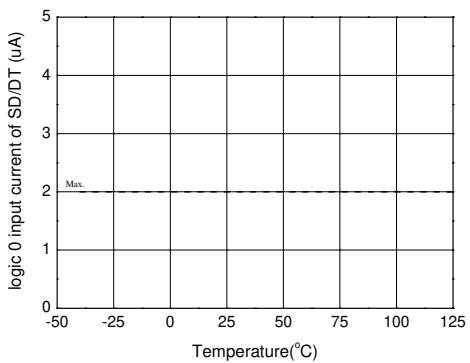

Figure 28. Logic 0 Input Current of SD/DT vs Temperature

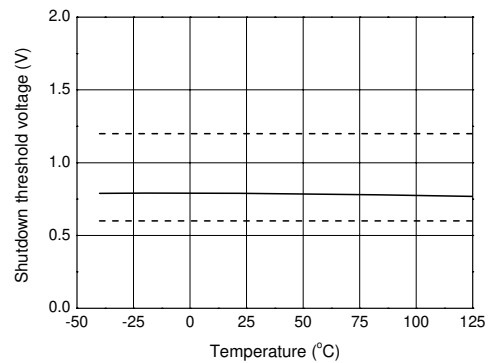

Figure 29. Shutdown Threshold of vs Temperature

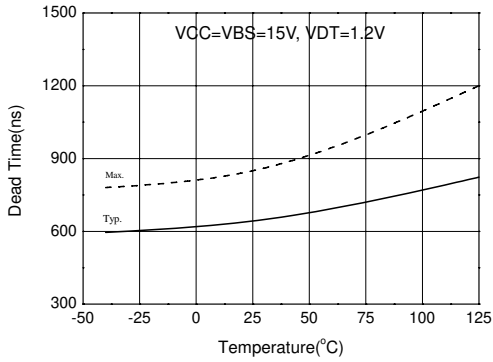

Figure 30. Deadtime vs Temperature

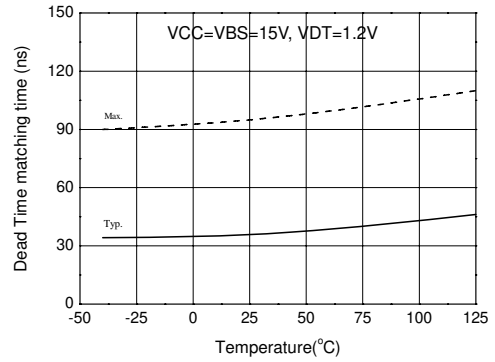

Figure 31. Deadtime Matching Time vs Temperature

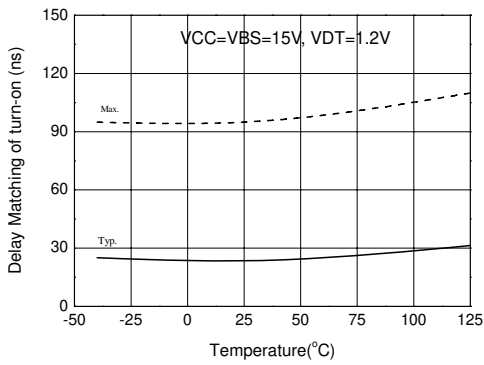

Figure 32. Turn-On Delay Matching vs Temperature

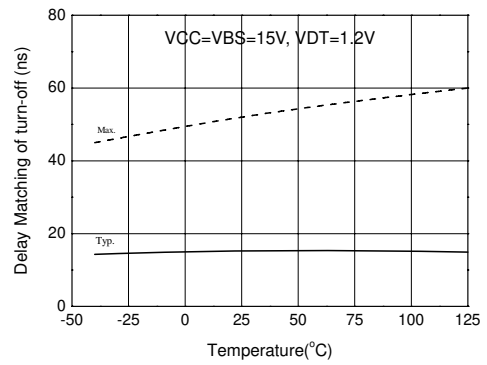

Figure 33. Turn_Off Delay Matching vs Temperature

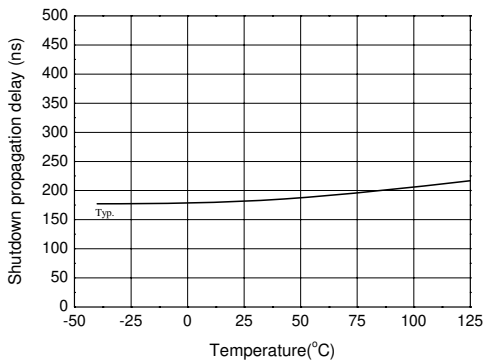

Figure 34. Shutdown Propagation Delay vs Temperature

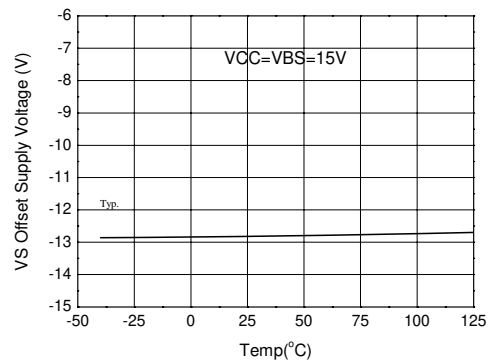
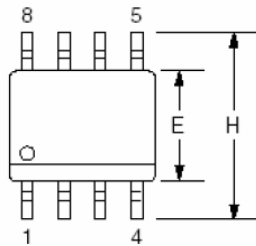

Figure 35. Maximum VS Negative Offset of vs Temperature

Package Dimensions

8-SOP

Symbol	Inches		Millimeters		Notes
	Min.	Max.	Min.	Max.	
A	.053	.069	1.35	1.75	
A1	.004	.010	0.10	0.25	
B	.013	.020	0.33	0.51	
C	.0075	.010	0.20	0.25	5
D	.189	.197	4.80	5.00	2
E	.150	.158	3.81	4.01	2
e	.050 BSC		1.27 BSC		
H	.228	.244	5.79	6.20	
h	.010	.020	0.25	0.50	
L	.016	.050	0.40	1.27	3
N	8		8		6
α	0°	8°	0°	8°	
ccc	—	.004	—	0.10	



Notes:

1. Dimensioning and tolerancing per ANSI Y14.5M-1982.
2. "D" and "E" do not include mold flash. Mold flash or protrusions shall not exceed .010 inch (0.25mm).
3. "L" is the length of terminal for soldering to a substrate.
4. Terminal numbers are shown for reference only.
5. "C" dimension does not include solder finish thickness.
6. Symbol "N" is the maximum number of terminals.

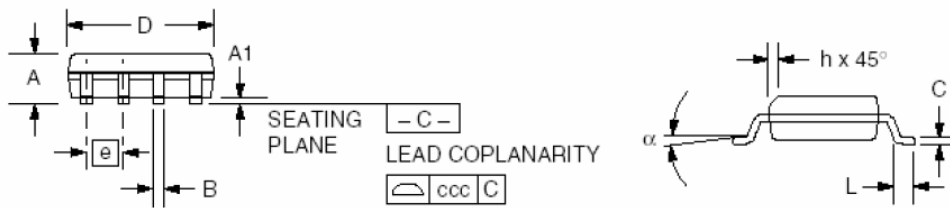



TRADEMARKS

The following includes registered and unregistered trademarks and service marks, owned by Fairchild Semiconductor and/or its global subsidiaries, and is not intended to be an exhaustive list of all such trademarks.

- | | | | |
|--------------------------|-------------------------------------|---------------------------------------|--|
| AccuPower™ | FlashWriter®* | Power-SPM™ | <p>SYSTEM GENERAL®
The Power Franchise®</p> <p>the power™
franchise</p> <p>TinyBoost™</p> <p>TinyBuck™</p> <p>TinyCalc™</p> <p>TinyLogic®</p> <p>TINYOPTO™</p> <p>TinyPower™</p> <p>TinyPWM™</p> <p>TinyWire™</p> <p>TriFault Detect™</p> <p>TRUECURRENT™*</p> <p>µSerDes™</p> <p>UHC®</p> <p>Ultra FRFET™</p> <p>UniFET™</p> <p>VCX™</p> <p>VisualMax™</p> <p>XS™</p> |
| Auto-SPM™ | FPS™ | PowerTrench® | |
| Build it Now™ | F-PFS™ | PowerXS™ | |
| CorePLUS™ | FRFET® | Programmable Active Droop™ | |
| CorePOWER™ | Global Power Resource SM | QFET® | |
| CROSSVOLT™ | Green FPS™ | QS™ | |
| CTL™ | Green FPS™ e-Series™ | Quiet Series™ | |
| Current Transfer Logic™ | Gmax™ | RapidConfigure™ | |
| EcoSPARK® | GTO™ | ™ | |
| EfficientMax™ | IntelliMAX™ | Saving our world, 1mW/W/kW at a time™ | |
| EZSWITCH™* | ISOPLANAR™ | SignalWise™ | |
| ™* | MegaBuck™ | SmartMax™ | |
| DEUXPEED™ | MICROCOUPLER™ | SMART START™ | |
| ™ | MicroFET™ | SPM® | |
| Fairchild® | MicroPak™ | STEALTH™ | |
| Fairchild Semiconductor® | MillerDrive™ | SuperFET™ | |
| FACT Quiet Series™ | MotionMax™ | SuperSOT™-3 | |
| FACT® | Motion-SPM™ | SuperSOT™-6 | |
| FAST® | OPTOLOGIC® | SuperSOT™-8 | |
| FAST® | OPTOPLANAR® | SupreMOS™ | |
| FastvCore™ | ™ | SyncFET™ | |
| FETBench™ | | Sync-Lock™ | |

* Trademarks of System General Corporation, used under license by Fairchild Semiconductor.

DISCLAIMER

FAIRCHILD SEMICONDUCTOR RESERVES THE RIGHT TO MAKE CHANGES WITHOUT FURTHER NOTICE TO ANY PRODUCTS HEREIN TO IMPROVE RELIABILITY, FUNCTION, OR DESIGN. FAIRCHILD DOES NOT ASSUME ANY LIABILITY ARISING OUT OF THE APPLICATION OR USE OF ANY PRODUCT OR CIRCUIT DESCRIBED HEREIN; NEITHER DOES IT CONVEY ANY LICENSE UNDER ITS PATENT RIGHTS, NOR THE RIGHTS OF OTHERS. THESE SPECIFICATIONS DO NOT EXPAND THE TERMS OF FAIRCHILD'S WORLDWIDE TERMS AND CONDITIONS, SPECIFICALLY THE WARRANTY THEREIN, WHICH COVERS THESE PRODUCTS.

LIFE SUPPORT POLICY

FAIRCHILD'S PRODUCTS ARE NOT AUTHORIZED FOR USE AS CRITICAL COMPONENTS IN LIFE SUPPORT DEVICES OR SYSTEMS WITHOUT THE EXPRESS WRITTEN APPROVAL OF FAIRCHILD SEMICONDUCTOR CORPORATION.

As used herein:

- Life support devices or systems are devices or systems which, (a) are intended for surgical implant into the body or (b) support or sustain life, and (c) whose failure to perform when properly used in accordance with instructions for use provided in the labeling, can be reasonably expected to result in a significant injury of the user.
- A critical component in any component of a life support, device, or system whose failure to perform can be reasonably expected to cause the failure of the life support device or system, or to affect its safety or effectiveness.

ANTI-COUNTERFEITING POLICY

Fairchild Semiconductor Corporation's Anti-Counterfeiting Policy. Fairchild's Anti-Counterfeiting Policy is also stated on our external website, www.fairchildsemi.com, under Sales Support.

Counterfeiting of semiconductor parts is a growing problem in the industry. All manufacturers of semiconductor products are experiencing counterfeiting of their parts. Customers who inadvertently purchase counterfeit parts experience many problems such as loss of brand reputation, substandard performance, failed applications, and increased cost of production and manufacturing delays. Fairchild is taking strong measures to protect ourselves and our customers from the proliferation of counterfeit parts. Fairchild strongly encourages customers to purchase Fairchild parts either directly from Fairchild or from Authorized Fairchild Distributors who are listed by country on our web page cited above. Products customers buy either from Fairchild directly or from Authorized Fairchild Distributors are genuine parts, have full traceability, meet Fairchild's quality standards for handling and storage and provide access to Fairchild's full range of up-to-date technical and product information. Fairchild and our Authorized Distributors will stand behind all warranties and will appropriately address any warranty issues that may arise. Fairchild will not provide any warranty coverage or other assistance for parts bought from Unauthorized Sources. Fairchild is committed to combat this global problem and encourage our customers to do their part in stopping this practice by buying direct or from authorized distributors.

PRODUCT STATUS DEFINITIONS

Definition of Terms

Datasheet Identification	Product Status	Definition
Advance Information	Formative / In Design	Datasheet contains the design specifications for product development. Specifications may change in any manner without notice.
Preliminary	First Production	Datasheet contains preliminary data; supplementary data will be published at a later date. Fairchild Semiconductor reserves the right to make changes at any time without notice to improve design.
No Identification Needed	Full Production	Datasheet contains final specifications. Fairchild Semiconductor reserves the right to make changes at any time without notice to improve the design.
Obsolete	Not In Production	Datasheet contains specifications on a product that is discontinued by Fairchild Semiconductor. The datasheet is for reference information only.

Rev. 143