



## APG1005VGC-T-5MAV

1.0 x 0.5 x 0.2 mm (0402) SMD Chip LED Lamp

### DESCRIPTIONS

- The Green source color devices are made with InGaN on SiC substrate Light Emitting Diode
- Electrostatic discharge and power surge could damage the LEDs
- It is recommended to use a wrist band or anti-electrostatic glove when handling the LEDs
- All devices, equipments and machineries must be electrically grounded

### FEATURES

- 1.0 mm x 0.5 mm SMD LED, 0.2 mm thickness
- Low power consumption
- Wide viewing angle
- Compatible with automatic placement equipment
- Ideal for backlight and indicator
- Package: 4000 pcs / reel
- Moisture sensitivity level: 3
- RoHS compliant

### APPLICATIONS

- Backlight
- Status indicator
- Home and smart appliances
- Wearable and portable devices
- Healthcare applications

### ATTENTION

Observe precautions for handling electrostatic discharge sensitive devices



### PACKAGE DIMENSIONS

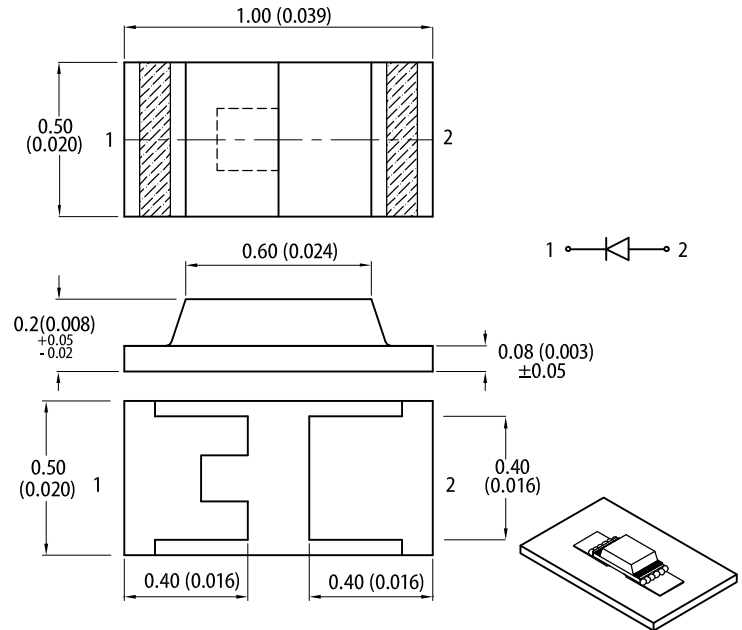

### RECOMMENDED SOLDERING PATTERN

(units : mm; tolerance : ± 0.1)

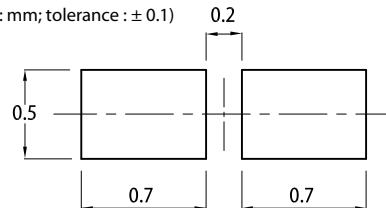

Mask open area ratio: 80%  
Mask thickness: 80~100um

#### Notes:

1. All dimensions are in millimeters (inches).
2. Tolerance is ±0.1(0.004") unless otherwise noted.
3. The specifications, characteristics and technical data described in the datasheet are subject to change without prior notice.
4. The device has a single mounting surface. The device must be mounted according to the specifications.

### SELECTION GUIDE

Part Number	Emitting Color (Material)	Lens Type	Iv (mcd) @ 5mA <sup>[2]</sup>		Viewing Angle <sup>[1]</sup>
			Min.	Typ.	2θ1/2
APG1005VGC-T-5MAV	■ Green (InGaN)	Water Clear	30	70	140°

Notes:  
1. θ1/2 is the angle from optical centerline where the luminous intensity is 1/2 of the optical peak value.  
2. Luminous intensity / luminous flux: +/-15%.  
3. Luminous intensity value is traceable to CIE127-2007 standards.

**ELECTRICAL / OPTICAL CHARACTERISTICS at T<sub>A</sub>=25°C**

Parameter	Symbol	Emitting Color	Value		Unit
			Typ.	Max.	
Wavelength at Peak Emission I <sub>F</sub> = 5mA	$\lambda_{\text{peak}}$	Green	518	-	nm
Dominant Wavelength I <sub>F</sub> = 5mA	$\lambda_{\text{dom}}$ <sup>[1]</sup>	Green	527	-	nm
Spectral Bandwidth at 50% $\Phi$ REL MAX I <sub>F</sub> = 5mA	$\Delta\lambda$	Green	35	-	nm
Forward Voltage I <sub>F</sub> = 5mA	V <sub>F</sub> <sup>[2]</sup>	Green	3.0	3.2	V
Reverse Current (V <sub>R</sub> = 5V)	I <sub>R</sub>	Green	-	50	$\mu$ A
Temperature Coefficient of $\lambda_{\text{peak}}$ I <sub>F</sub> = 5mA, -10°C ≤ T ≤ 85°C	TC <sub><math>\lambda_{\text{peak}}</math></sub>	Green	0.05	-	nm/°C
Temperature Coefficient of $\lambda_{\text{dom}}$ I <sub>F</sub> = 5mA, -10°C ≤ T ≤ 85°C	TC <sub><math>\lambda_{\text{dom}}</math></sub>	Green	0.03	-	nm/°C
Temperature Coefficient of V <sub>F</sub> I <sub>F</sub> = 5mA, -10°C ≤ T ≤ 85°C	TC <sub>V</sub>	Green	-3	-	mV/°C

## Notes:

1. The dominant wavelength ( $\lambda_d$ ) above is the setup value of the sorting machine. (Tolerance  $\lambda_d$  :  $\pm 1\text{nm}$ .)
2. Forward voltage:  $\pm 0.1\text{V}$ .
3. Wavelength value is traceable to CIE127-2007 standards.
4. Excess driving current and / or operating temperature higher than recommended conditions may result in severe light degradation or premature failure.

**ABSOLUTE MAXIMUM RATINGS at T<sub>A</sub>=25°C**

Parameter	Symbol	Value	Unit
Power Dissipation	P <sub>D</sub>	34	mW
Reverse Voltage	V <sub>R</sub>	5	V
Junction Temperature	T <sub>j</sub>	125	°C
Operating Temperature	T <sub>op</sub>	-40 to +85	°C
Storage Temperature	T <sub>stg</sub>	-40 to +85	°C
DC Forward Current	I <sub>F</sub>	10	mA
Peak Forward Current	I <sub>FM</sub> <sup>[1]</sup>	50	mA
Electrostatic Discharge Threshold (HBM)	-	1000	V
Thermal Resistance (Junction / Ambient)	R <sub>th JA</sub> <sup>[2]</sup>	385	°C/W
Thermal Resistance (Junction / Solder point)	R <sub>th JS</sub> <sup>[2]</sup>	260	°C/W

## Notes:

1. 1/10 Duty Cycle, 0.1ms Pulse Width.
2. R<sub>th JA</sub>, R<sub>th JS</sub> Results from mounting on PC board FR4 (pad size  $\geq 16\text{mm}^2$  per pad).
3. Relative humidity levels maintained between 40% and 60% in production area are recommended to avoid the build-up of static electricity – Ref JEDEC/JESD625-A and JEDEC/J-STD-033.

### TECHNICAL DATA

#### RELATIVE INTENSITY vs. WAVELENGTH

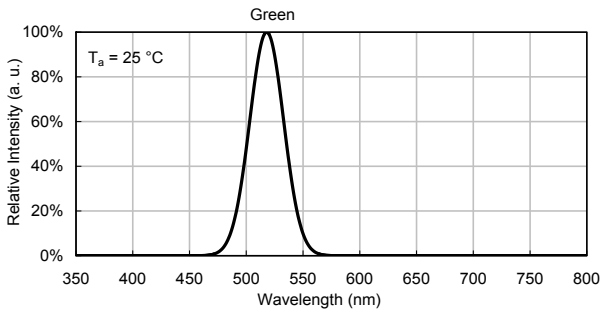

#### SPATIAL DISTRIBUTION

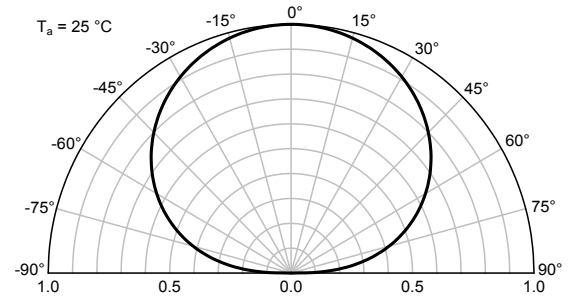

### GREEN

Forward Current vs. Forward Voltage

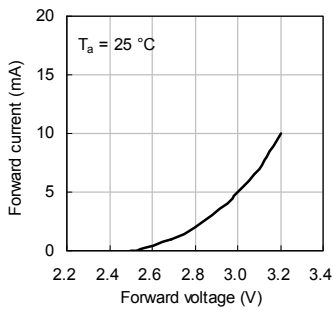

Luminous Intensity vs. Forward Current

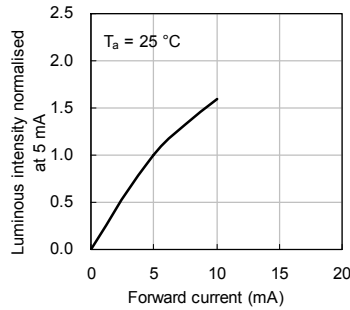

Forward Current Derating Curve

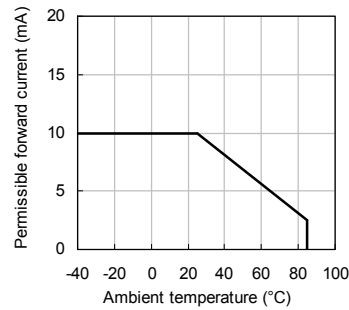

Luminous Intensity vs. Ambient Temperature

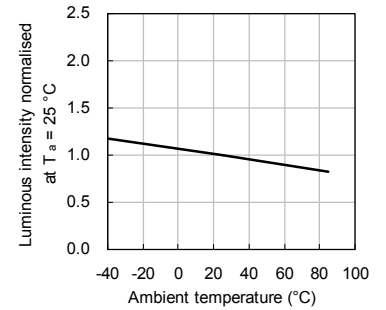

#### REFLOW SOLDERING PROFILE for LEAD-FREE SMD PROCESS

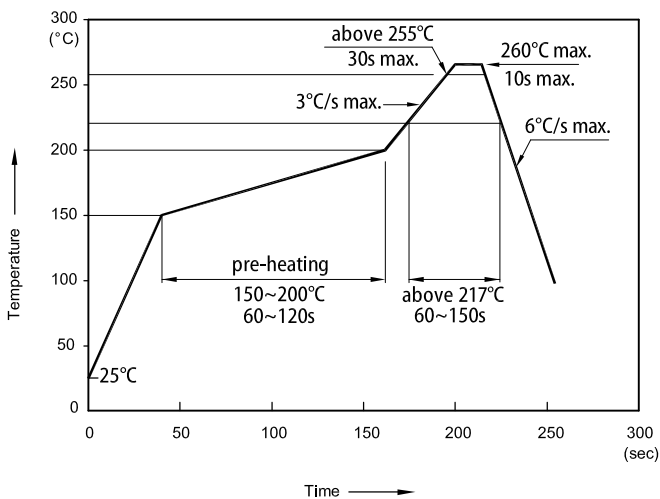

#### TAPE SPECIFICATIONS (units : mm)

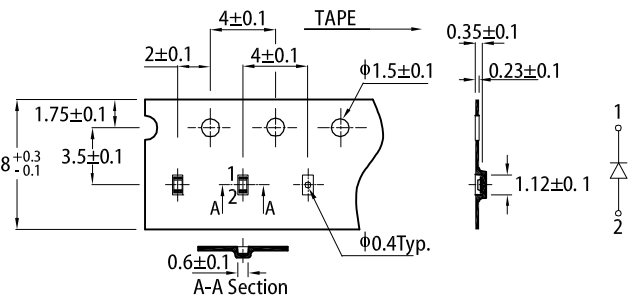

#### REEL DIMENSION (units : mm)

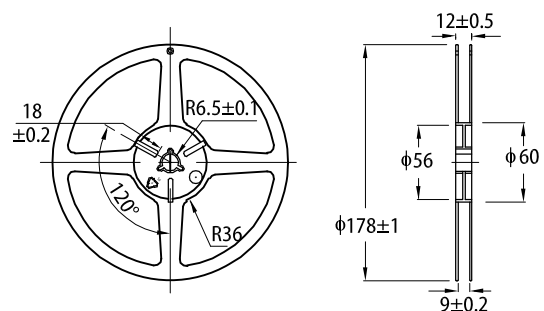

- Notes:
1. Don't cause stress to the LEDs while it is exposed to high temperature.
  2. The maximum number of reflow soldering passes is 2 times.
  3. Reflow soldering is recommended. Other soldering methods are not recommended as they might cause damage to the product.

## PACKING & LABEL SPECIFICATIONS

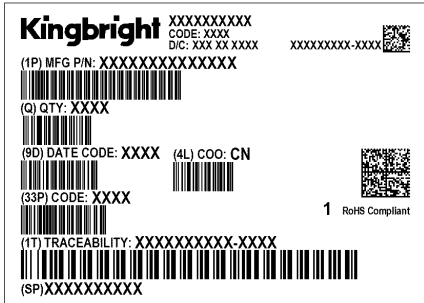
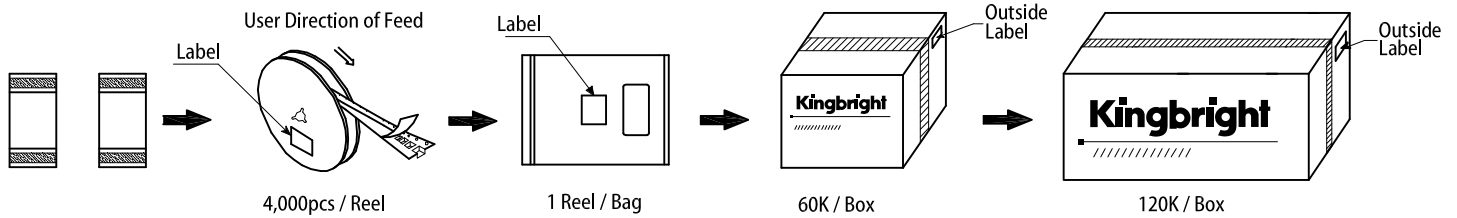

### PRECAUTIONARY NOTES

1. The information included in this document reflects representative usage scenarios and is intended for technical reference only.
2. The part number, type, and specifications mentioned in this document are subject to future change and improvement without notice. Before production usage customer should refer to the latest datasheet for the updated specifications.
3. When using the products referenced in this document, please make sure the product is being operated within the environmental and electrical limits specified in the datasheet. If customer usage exceeds the specified limits, Kingbright will not be responsible for any subsequent issues.
4. The information in this document applies to typical usage in consumer electronics applications. If customer's application has special reliability requirements or have life-threatening liabilities, such as automotive or medical usage, please consult with Kingbright representative for further assistance.
5. The contents and information of this document may not be reproduced or re-transmitted without permission by Kingbright.
6. All design applications should refer to Kingbright application notes available at <https://www.KingbrightUSA.com/ApplicationNotes>