

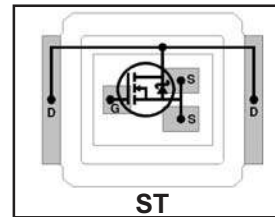
# IRF6623PbF

## IRF6623TRPbF

DirectFET™ Power MOSFET ⑩

- RoHS Compliant ⑨
- Lead-Free (Qualified up to 260°C Reflow)
- Application Specific MOSFETs
- Ideal for CPU Core DC-DC Converters
- Low Conduction Losses
- High Cdv/dt Immunity
- Low Profile (<0.7mm)
- Dual Sided Cooling Compatible ⑨
- Compatible with existing Surface Mount Techniques ⑨

V <sub>DSS</sub>	R <sub>DS(on)</sub> max	Qg(typ.)
20V	5.7mΩ @ V <sub>GS</sub> = 10V	11nC
	9.7mΩ @ V <sub>GS</sub> = 4.5V	



Applicable DirectFET Outline and Substrate Outline (see p.8,9 for details)

SQ	SX	<b>ST</b>		MQ	MX	MT			
----	----	-----------	--	----	----	----	--	--	--

### Description

The IRF6623PbF combines the latest HEXFET® Power MOSFET Silicon technology with the advanced DirectFET™ packaging to achieve the lowest on-state resistance in a package that has the footprint of a MICRO-8 and only 0.7 mm profile. The DirectFET package is compatible with existing layout geometries used in power applications, PCB assembly equipment and vapor phase, infra-red or convection soldering techniques, when application note AN-1035 is followed regarding the manufacturing methods and processes. The DirectFET package allows dual sided cooling to maximize thermal transfer in power systems, improving previous best thermal resistance by 80%.

The IRF6623PbF balances both low resistance and low charge along with ultra low package inductance to reduce both conduction and switching losses. The reduced total losses make this product ideal for high efficiency DC-DC converters that power the latest generation of processors operating at higher frequencies. The IRF6623PbF has been optimized for parameters that are critical in synchronous buck operating from 12 volt bus converters including Rds(on) and gate charge to minimize losses in the control FET socket.

### Absolute Maximum Ratings

	Parameter	Max.	Units
V <sub>DS</sub>	Drain-to-Source Voltage	20	V
V <sub>GS</sub>	Gate-to-Source Voltage	±20	
I <sub>D</sub> @ T <sub>C</sub> = 25°C	Continuous Drain Current, V <sub>GS</sub> @ 10V ⑦	55	A
I <sub>D</sub> @ T <sub>A</sub> = 25°C	Continuous Drain Current, V <sub>GS</sub> @ 10V ④	16	
I <sub>D</sub> @ T <sub>A</sub> = 70°C	Continuous Drain Current, V <sub>GS</sub> @ 10V ④	13	
I <sub>DM</sub>	Pulsed Drain Current ①	120	
P <sub>D</sub> @ T <sub>C</sub> = 25°C	Power Dissipation ⑦	42	W
P <sub>D</sub> @ T <sub>A</sub> = 25°C	Power Dissipation ④	1.4	
P <sub>D</sub> @ T <sub>A</sub> = 70°C	Power Dissipation ④	2.1	
E <sub>AS</sub>	Single Pulse Avalanche Energy ②	43	mJ
I <sub>AR</sub>	Avalanche Current ①	40	A
	Linear Derating Factor	0.017	W/°C
T <sub>J</sub>	Operating Junction and	-40 to + 150	°C
T <sub>STG</sub>	Storage Temperature Range		

### Thermal Resistance

	Parameter	Typ.	Max.	Units
R <sub>θJA</sub>	Junction-to-Ambient ④⑧	—	58	°C/W
R <sub>θJA</sub>	Junction-to-Ambient ⑤⑧	12.5	—	
R <sub>θJA</sub>	Junction-to-Ambient ⑥⑧	20	—	
R <sub>θJC</sub>	Junction-to-Case ⑦⑧	—	3.0	
R <sub>θJ-PCB</sub>	Junction-to-PCB Mounted	1.0	—	

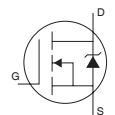
Notes ① through ⑩ are on page 2

Static @  $T_J = 25^\circ\text{C}$  (unless otherwise specified)

	Parameter	Min.	Typ.	Max.	Units	Conditions
$BV_{DSS}$	Drain-to-Source Breakdown Voltage	20	—	—	V	$V_{GS} = 0V, I_D = 250\mu A$
$\Delta BV_{DSS}/\Delta T_J$	Breakdown Voltage Temp. Coefficient	—	15	—	mV/°C	Reference to $25^\circ\text{C}, I_D = 1mA$
$R_{DS(on)}$	Static Drain-to-Source On-Resistance	—	4.4	5.7	mΩ	$V_{GS} = 10V, I_D = 15A$ ③
		—	7.5	9.7		$V_{GS} = 4.5V, I_D = 12A$ ③
$V_{GS(th)}$	Gate Threshold Voltage	1.4	—	2.2	V	$V_{DS} = V_{GS}, I_D = 250\mu A$
$\Delta V_{GS(th)}/\Delta T_J$	Gate Threshold Voltage Coefficient	—	-5.4	—	mV/°C	
$I_{DSS}$	Drain-to-Source Leakage Current	—	—	1.0	μA	$V_{DS} = 16V, V_{GS} = 0V$
		—	—	150		$V_{DS} = 16V, V_{GS} = 0V, T_J = 125^\circ\text{C}$
$I_{GSS}$	Gate-to-Source Forward Leakage	—	—	100	nA	$V_{GS} = 20V$
	Gate-to-Source Reverse Leakage	—	—	-100		$V_{GS} = -20V$
$g_{fs}$	Forward Transconductance	34	—	—	S	$V_{DS} = 10V, I_D = 12A$
$Q_g$	Total Gate Charge	—	11	17	nC	$V_{DS} = 10V$ $V_{GS} = 4.5V$ $I_D = 12A$ See Fig. 16
$Q_{gs1}$	Pre-Vth Gate-to-Source Charge	—	3.3	—		
$Q_{gs2}$	Post-Vth Gate-to-Source Charge	—	1.2	—		
$Q_{gd}$	Gate-to-Drain Charge	—	4.0	—		
$Q_{godr}$	Gate Charge Overdrive	—	2.5	—		
$Q_{sw}$	Switch Charge ( $Q_{gs2} + Q_{gd}$ )	—	5.2	—		
$Q_{oss}$	Output Charge	—	8.9	—	nC	$V_{DS} = 10V, V_{GS} = 0V$
$t_{d(on)}$	Turn-On Delay Time	—	9.7	—	ns	$V_{DD} = 16V, V_{GS} = 4.5V$ ③ $I_D = 12A$ Clamped Inductive Load
$t_r$	Rise Time	—	40	—		
$t_{d(off)}$	Turn-Off Delay Time	—	12	—		
$t_f$	Fall Time	—	4.5	—		
$C_{iss}$	Input Capacitance	—	1360	—	pF	$V_{GS} = 0V$ $V_{DS} = 10V$ $f = 1.0MHz$
$C_{oss}$	Output Capacitance	—	630	—		
$C_{rss}$	Reverse Transfer Capacitance	—	240	—		

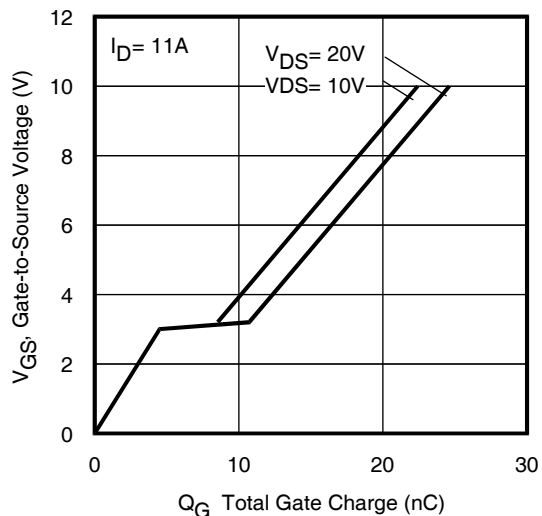
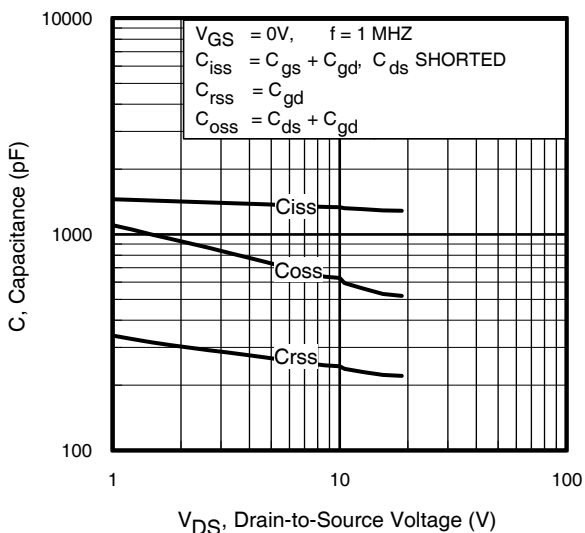
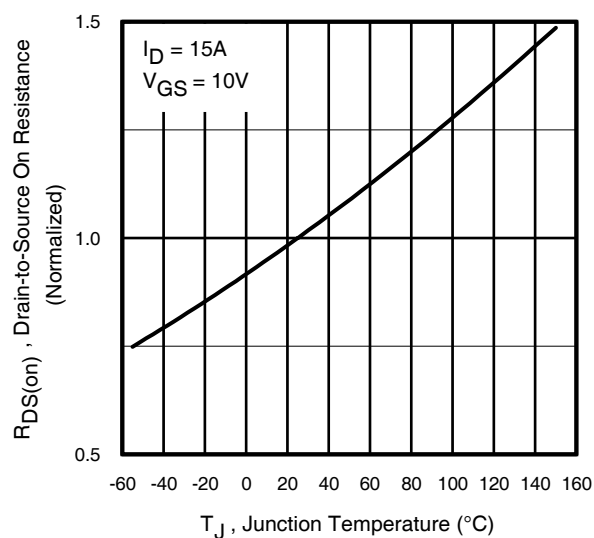
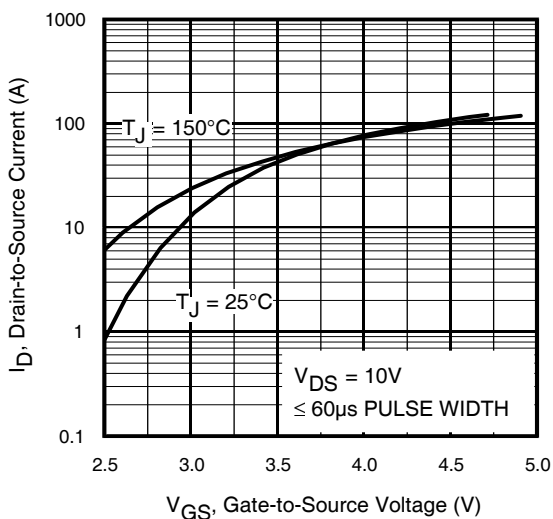
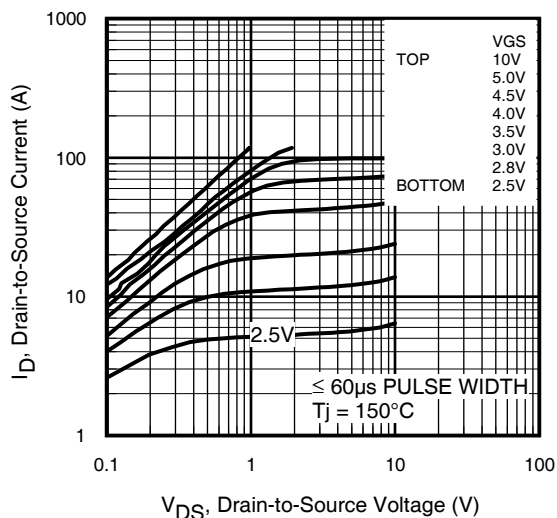
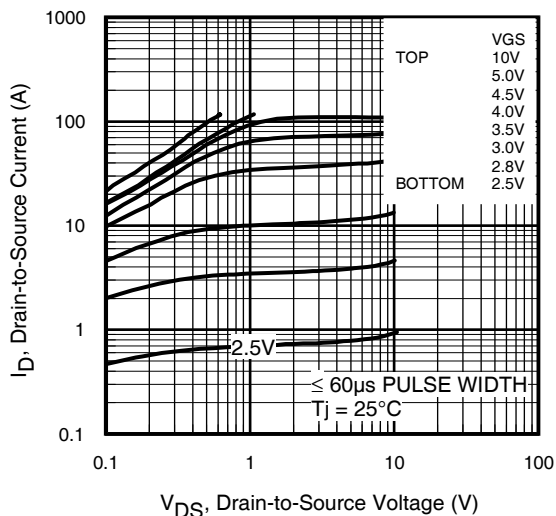
## Diode Characteristics

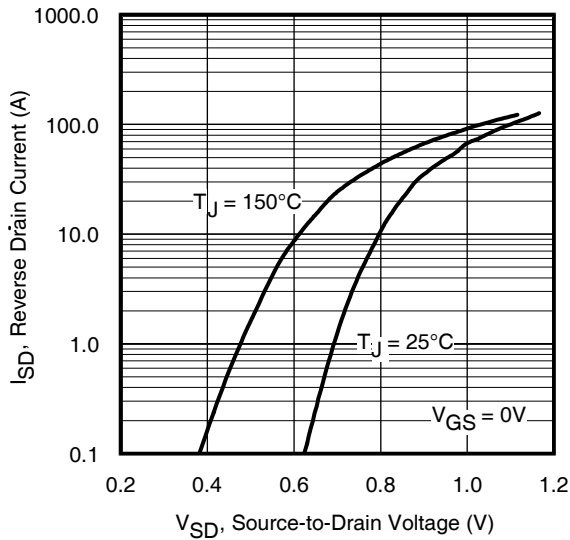
	Parameter	Min.	Typ.	Max.	Units	Conditions
$I_S$	Continuous Source Current (Body Diode)	—	—	53	A	MOSFET symbol showing the integral reverse p-n junction diode.
$I_{SM}$	Pulsed Source Current (Body Diode) ①	—	—	120		
$V_{SD}$	Diode Forward Voltage	—	0.81	1.0	V	$T_J = 25^\circ\text{C}, I_S = 12A, V_{GS} = 0V$ ③
$t_{rr}$	Reverse Recovery Time	—	20	30	ns	$T_J = 25^\circ\text{C}, I_F = 12A$
$Q_{rr}$	Reverse Recovery Charge	—	12	18	nC	$di/dt = 100A/\mu s$ ③



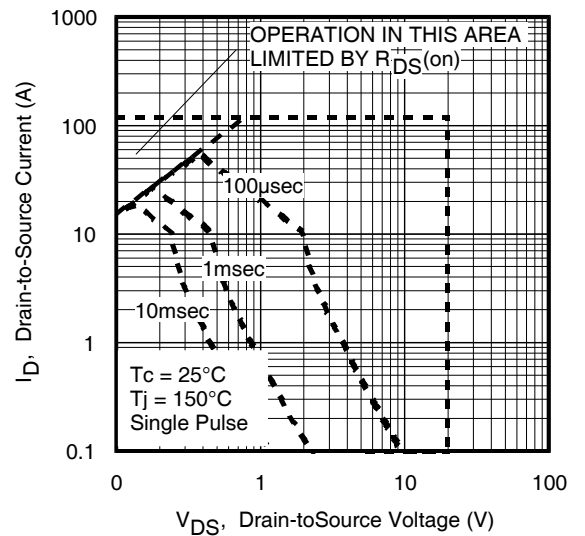
### Notes:

- ① Repetitive rating; pulse width limited by max. junction temperature.
- ② Starting  $T_J = 25^\circ\text{C}, L = 0.61mH, R_G = 25\Omega, I_{AS} = 12A$ .
- ③ Pulse width  $\leq 400\mu s$ ; duty cycle  $\leq 2\%$ .
- ④ Surface mounted on 1 in. square Cu board.
- ⑤ Used double sided cooling, mounting pad.
- ⑥ Mounted on minimum footprint full size board with metalized back and with small clip heatsink.
- ⑦  $T_C$  measured with thermal couple mounted to top (Drain) of part.
- ⑧  $R_\theta$  is measured at  $T_J$  of approximately  $90^\circ\text{C}$ .
- ⑨ Click on this section to link to the appropriate technical paper.
- ⑩ Click on this section to link to the DirectFET Website.

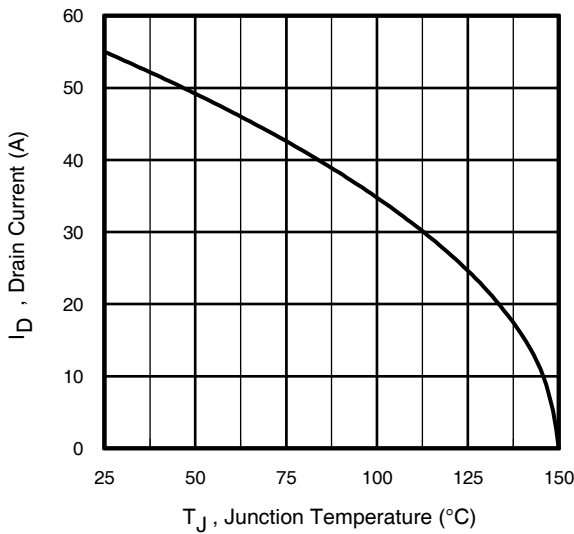




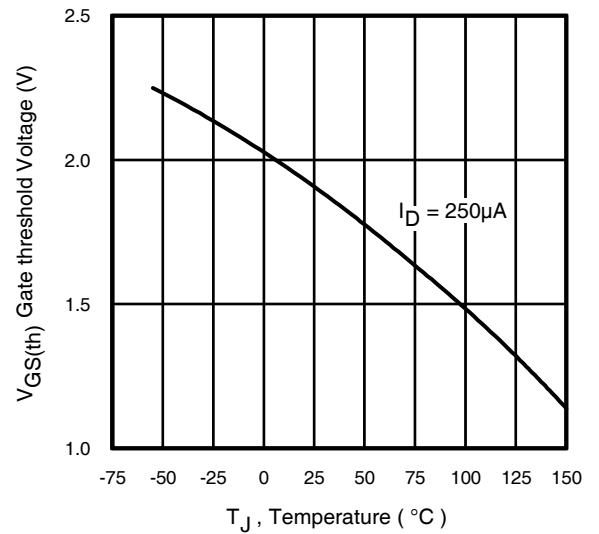
**Fig 7.** Typical Source-Drain Diode Forward Voltage



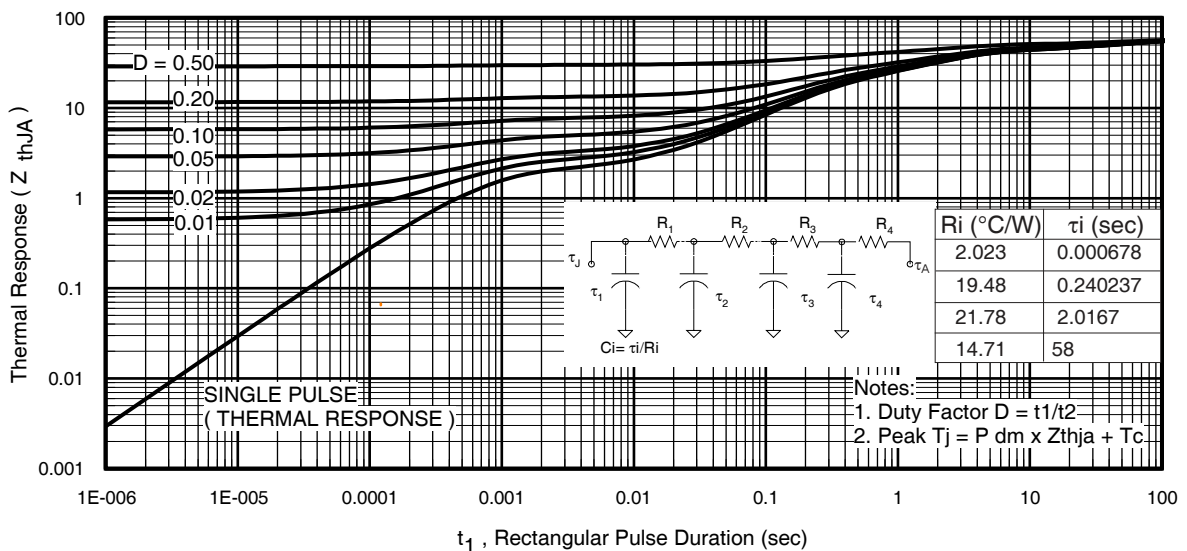
**Fig 8.** Maximum Safe Operating Area



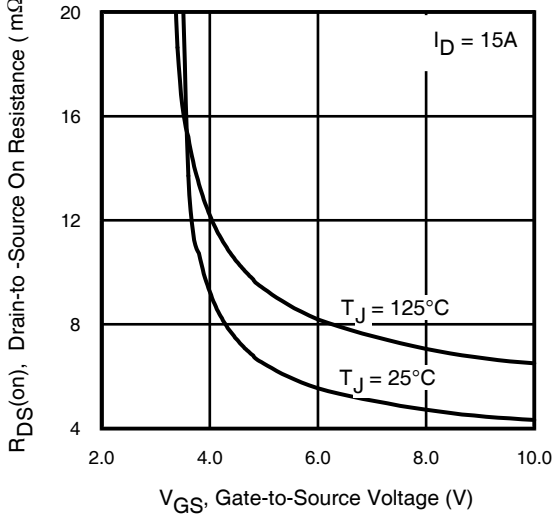
**Fig 9.** Maximum Drain Current vs. Case Temperature



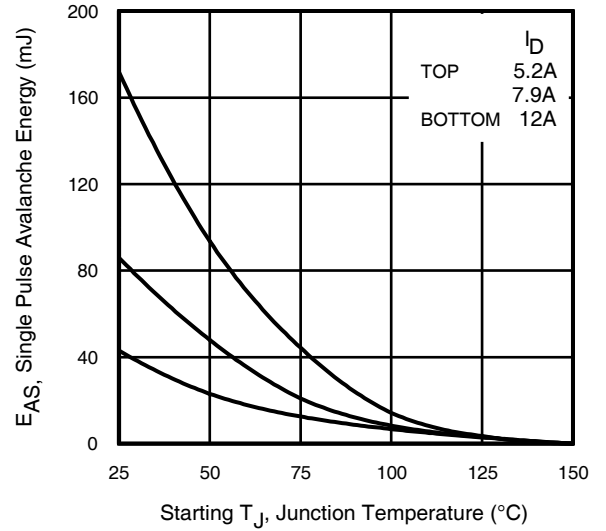
**Fig 10.** Threshold Voltage vs. Temperature



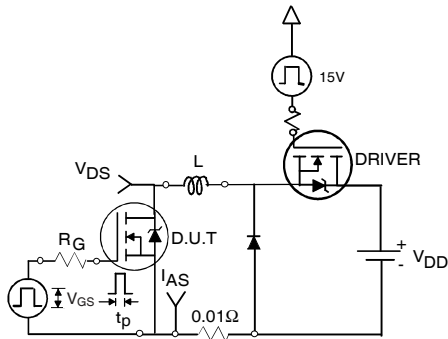
**Fig 11.** Maximum Effective Transient Thermal Impedance, Junction-to-Ambient



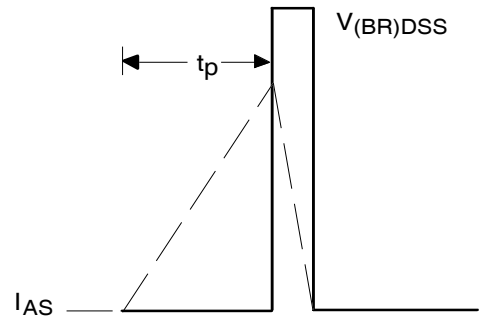
**Fig 12.** On-Resistance Vs. Gate Voltage



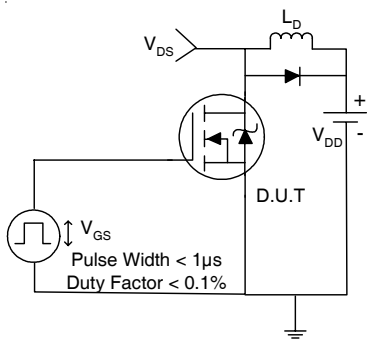
**Fig 13.** Maximum Avalanche Energy Vs. Drain Current



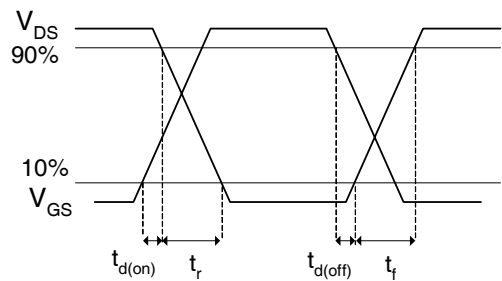
**Fig 14a.** Unclamped Inductive Test Circuit



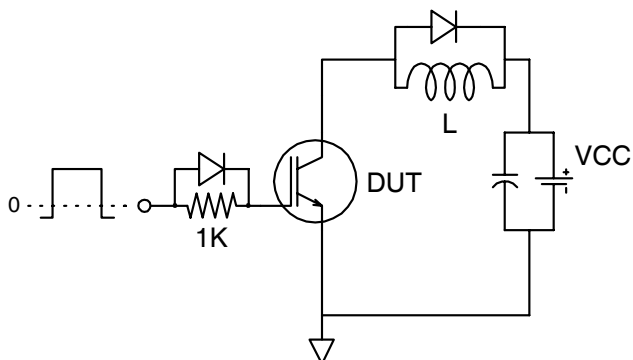
**Fig 14b.** Unclamped Inductive Waveforms



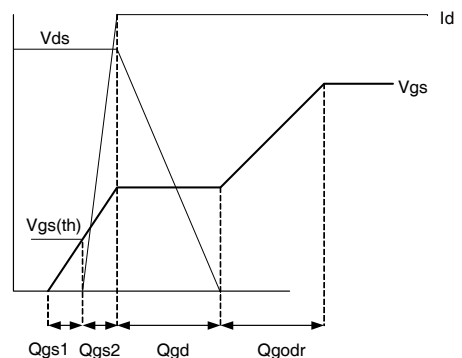
**Fig 15a.** Switching Time Test Circuit



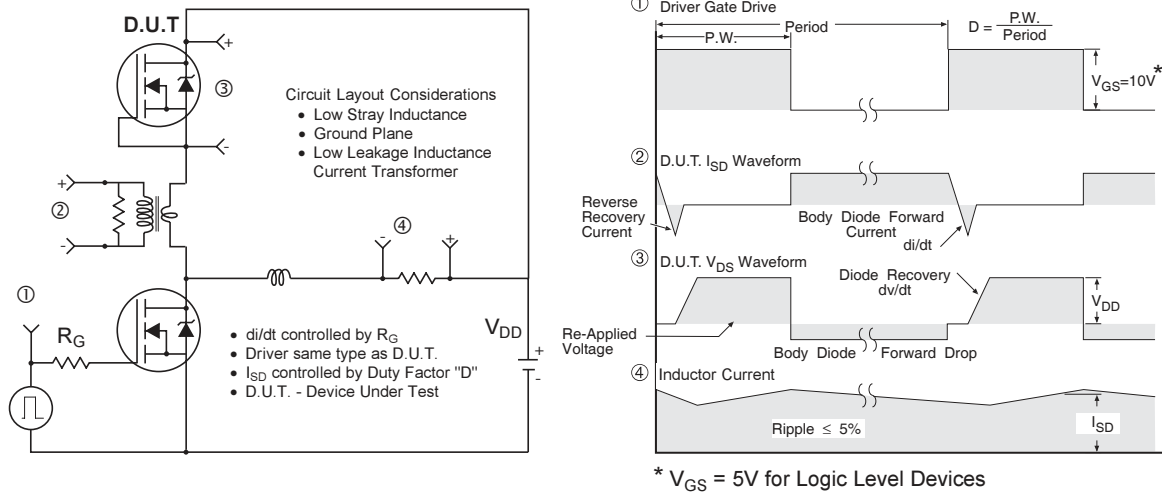
**Fig 15b.** Switching Time Waveforms



**Fig 16a.** Gate Charge Test Circuit



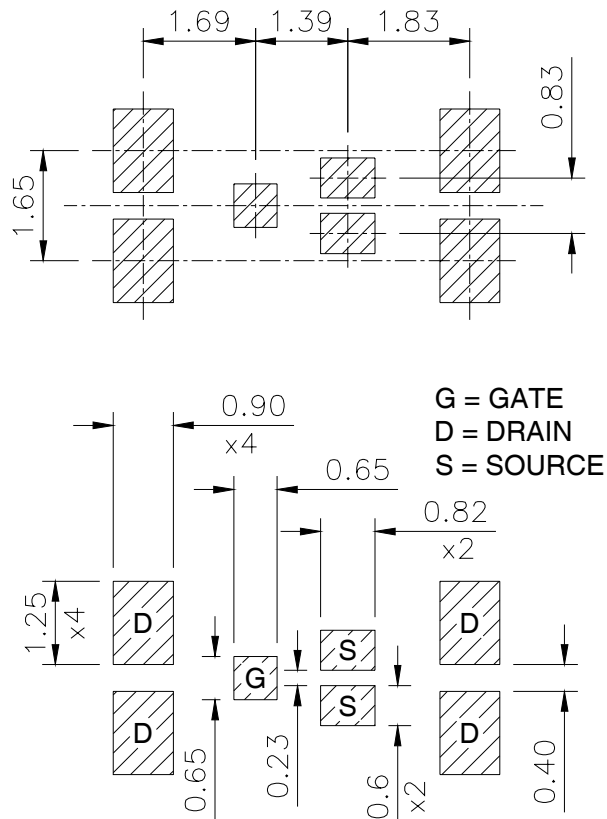
**Fig 16b.** Gate Charge Waveform



**Fig 17.** Diode Reverse Recovery Test Circuit for N-Channel HEXFET® Power MOSFETs

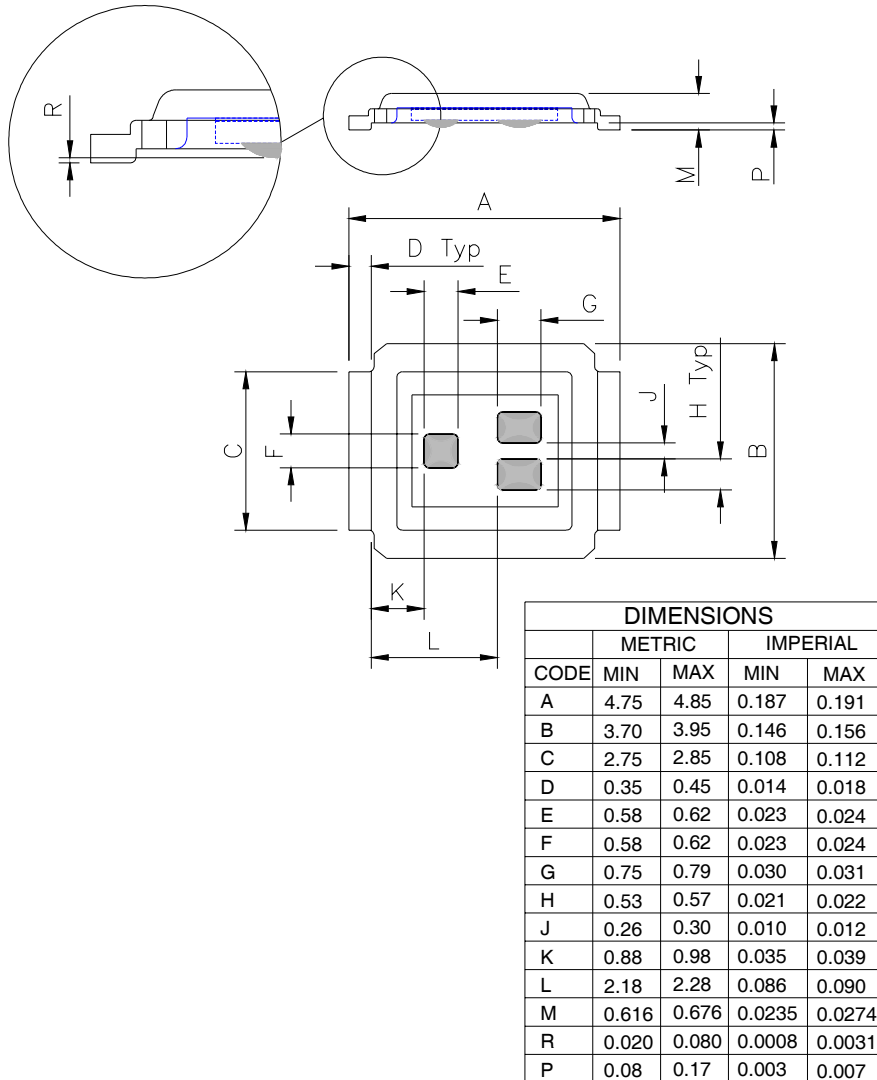
## DirectFET™ Substrate and PCB Layout, ST Outline (Small Size Can, T-Designation).

Please see DirectFET application note AN-1035 for all details regarding the assembly of DirectFET. This includes all recommendations for stencil and substrate designs.

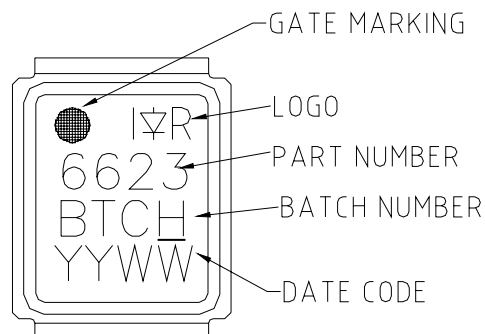


## DirectFET™ Outline Dimension, ST Outline (Small Size Can, T-Designation).

Please see DirectFET application note AN-1035 for all details regarding the assembly of DirectFET. This includes all recommendations for stencil and substrate designs.



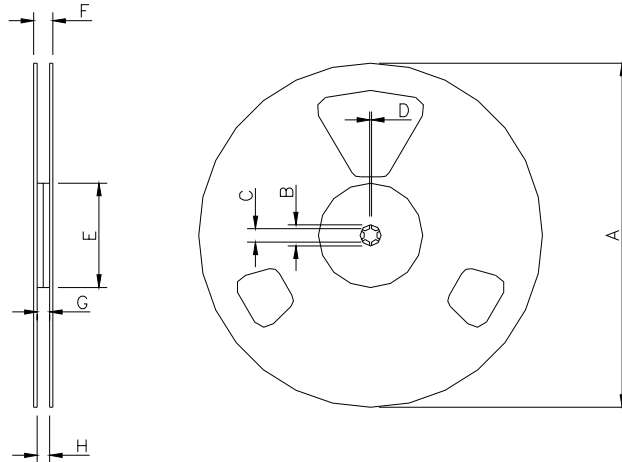
## DirectFET™ Part Marking



Note: Line above the last character of the date-code indicates "Lead-Free".

# IRF6623PbF

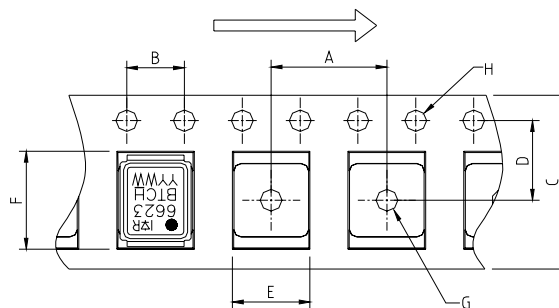
DirectFET™ Tape & Reel Dimension (Showing component orientation).



NOTE: Controlling dimensions in mm  
Std reel quantity is 4800 parts. (ordered as IRF6623TRPBF). For 1000 parts on 7" reel, order IRF6623TR1PBF

REEL DIMENSIONS								
CODE	STANDARD OPTION (QTY 4800)				TR1 OPTION (QTY 1000)			
	METRIC		IMPERIAL		METRIC		IMPERIAL	
	MIN	MAX	MIN	MAX	MIN	MAX	MIN	MAX
A	330.0	N.C	12.992	N.C	177.77	N.C	6.9	N.C
B	20.2	N.C	0.795	N.C	19.06	N.C	0.75	N.C
C	12.8	13.2	0.504	0.520	13.5	12.8	0.53	0.50
D	1.5	N.C	0.059	N.C	1.5	N.C	0.059	N.C
E	100.0	N.C	3.937	N.C	58.72	N.C	2.31	N.C
F	N.C	18.4	N.C	0.724	N.C	13.50	N.C	0.53
G	12.4	14.4	0.488	0.567	11.9	12.01	0.47	N.C
H	11.9	15.4	0.469	0.606	11.9	12.01	0.47	N.C

Loaded Tape Feed Direction



CODE	DIMENSIONS			
	METRIC		IMPERIAL	
	MIN	MAX	MIN	MAX
A	7.90	8.10	0.311	0.319
B	3.90	4.10	0.154	0.161
C	11.90	12.30	0.469	0.484
D	5.45	5.55	0.215	0.219
E	4.00	4.20	0.158	0.165
F	5.00	5.20	0.197	0.205
G	1.50	N.C	0.059	N.C
H	1.50	1.60	0.059	0.063

Data and specifications subject to change without notice.  
This product has been designed and qualified for the Consumer market.  
Qualification Standards can be found on IR's Web site.



Note: For the most current drawings please refer to the IR website at:  
<http://www.irf.com/package/>

## **IMPORTANT NOTICE**

The information given in this document shall in no event be regarded as a guarantee of conditions or characteristics ("Beschaffheitsgarantie").

With respect to any examples, hints or any typical values stated herein and/or any information regarding the application of the product, Infineon Technologies hereby disclaims any and all warranties and liabilities of any kind, including without limitation warranties of non-infringement of intellectual property rights of any third party.

In addition, any information given in this document is subject to customer's compliance with its obligations stated in this document and any applicable legal requirements, norms and standards concerning customer's products and any use of the product of Infineon Technologies in customer's applications.

The data contained in this document is exclusively intended for technically trained staff. It is the responsibility of customer's technical departments to evaluate the suitability of the product for the intended application and the completeness of the product information given in this document with respect to such application.

For further information on the product, technology, delivery terms and conditions and prices please contact your nearest Infineon Technologies office ([www.infineon.com](http://www.infineon.com)).

## **WARNINGS**

Due to technical requirements products may contain dangerous substances. For information on the types in question please contact your nearest Infineon Technologies office.

Except as otherwise explicitly approved by Infineon Technologies in a written document signed by authorized representatives of Infineon Technologies, Infineon Technologies' products may not be used in any applications where a failure of the product or any consequences of the use thereof can reasonably be expected to result in personal injury.