

## 1. Features

- GSM/UMTS antenna supporting up to five frequency bands
- High efficiency
- Easy to Integrate
- Intended for SMD mounting
- Supplied in Tape and reel

Calvus support the following communication standards:

GSM/GPRS/EDGE	CDMA2000 1xRTT/EV-DO/EV-DV	UMTS WCDMA/HSPA	Other Standards
GSM850 (E)GSM900 GSM1800 (DCS) GSM1900 (PCS)	Band Classes: 1,2,3,4,6,8,9,12,14,15	Bands I – VI Bands VIII – X	Korean PCS DECT TD-SCDMA AWS

## 2. Description

Calvus uses a ground plane to radiate efficiently, but the ground plane must not be present underneath the antenna itself.

The antenna uses a matching circuit to achieve optimized results for the specific frequency bands that are required. This product specification shows the performance of the antenna when optimized to cover a typical penta-band reception: GSM850/900/1800/1900 and WCDMA. If the antenna is used for fewer than five bands, higher efficiencies are possible.

## 3. Applications

- Femto / Pico base stations
- Vehicle tracking
- Machine to machine communication
- Remote monitoring
- Remote security
- Vending machines



## 4. Part Number

Calvus: A10340H

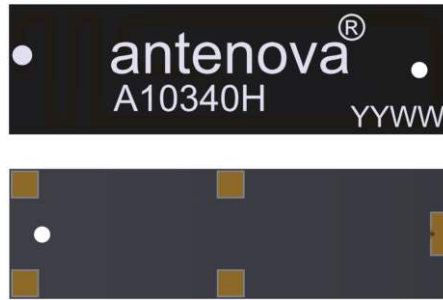

## 5. General Data

Product name	Calvus
Part Number	A10340H
Frequency	824 – 960MHz 1710 – 2170 MHz
Polarization	Linear
Operating temperature	-40°C to140°C
Environmental condition test	ISO 16750-4.5.1.1.1/5.1.2.1/5.3.2
Impedance with matching	50 $\Omega$
Weight	2.0 g
Antenna type	SMD
Dimensions	27.0 x 8.0 x 3.2 (mm)
Minimum Distance to GND	$\geq 5.6$ mm

## 6. RF Characteristics

	824 – 960 MHz	1710 - 2170 MHz
<b>Peak gain</b>	1.70dBi	3.0dBi
<b>Average gain (Linear)</b>	-1.80dBi	-1.60dBi
<b>Average efficiency</b>	>65%	>65%
<b>Maximum return loss</b>	-6dB	-6dB
<b>Maximum VSWR</b>	3.2:1	3.0:1

All data measured on Antenova's evaluation PCB  
Part No. A10340H-EVB-1

## 7. RF Performance

### 7.1 Return Loss

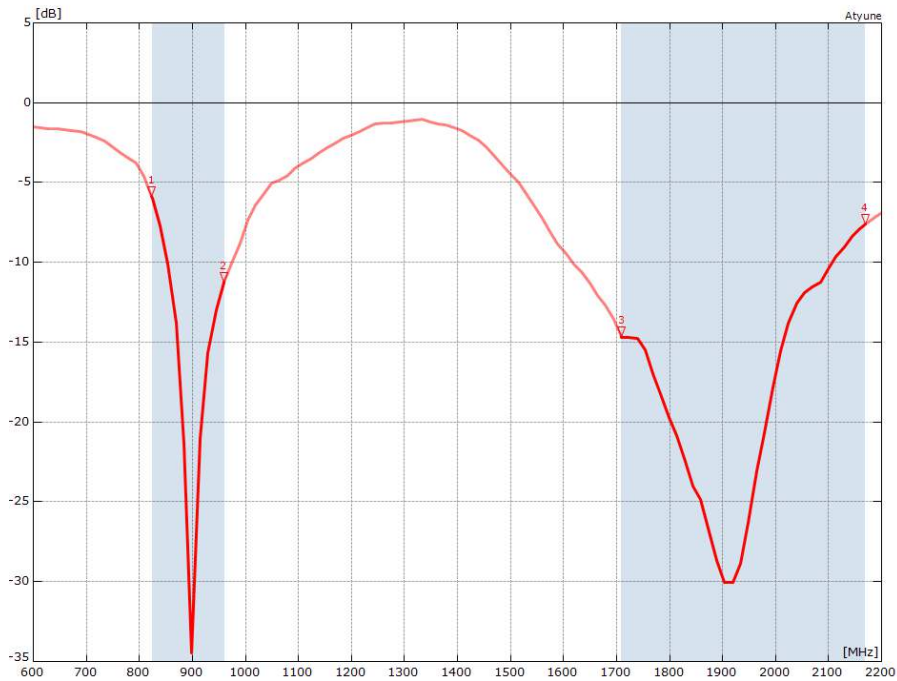

### 7.2 VSWR

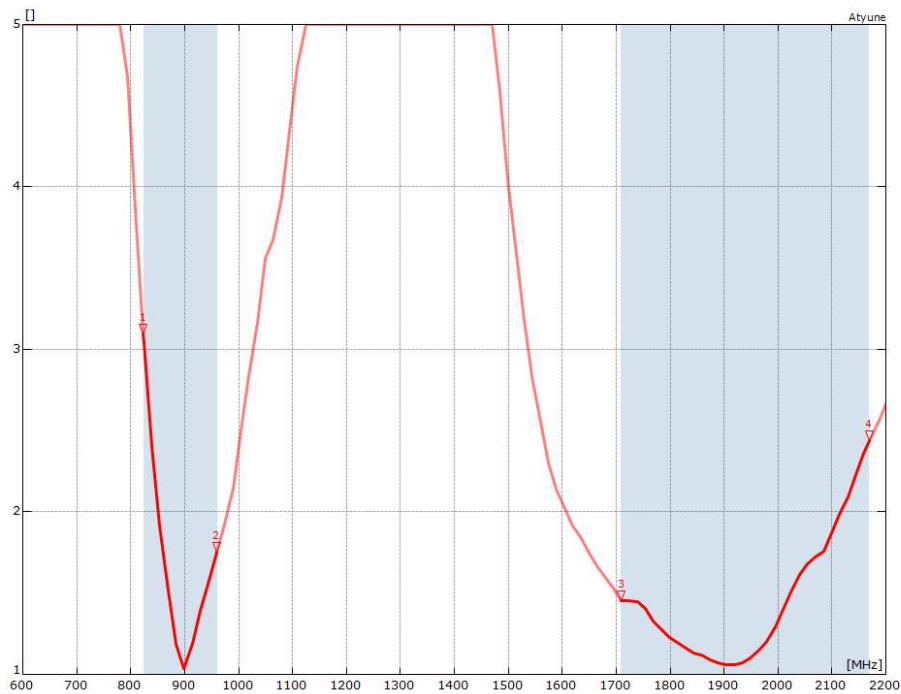

Antennas for Wireless Applications

## 7.3 Antenna pattern

### 7.3.1 824 MHz – 960 MHz

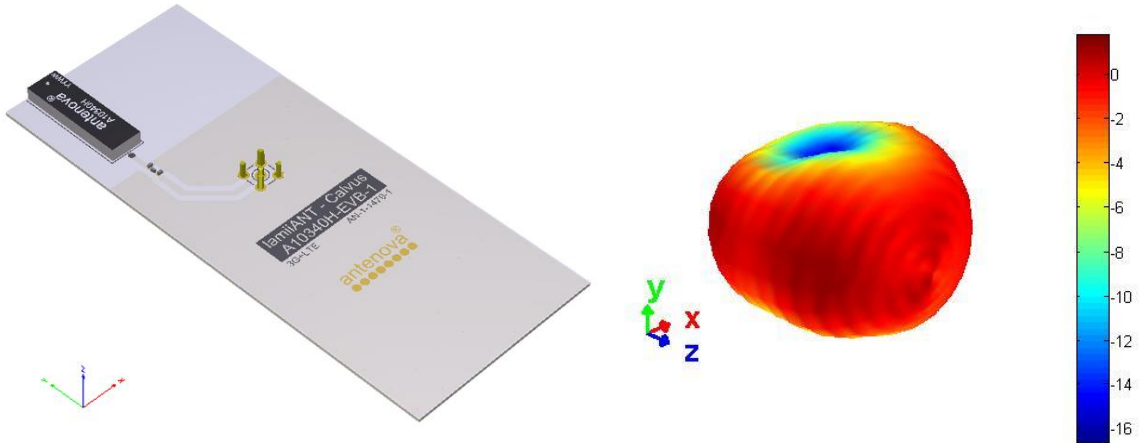

#### 3D pattern at 880 MHz

Drag to rotate pattern and PCB by using Adobe Reader  
(Click to Activate)

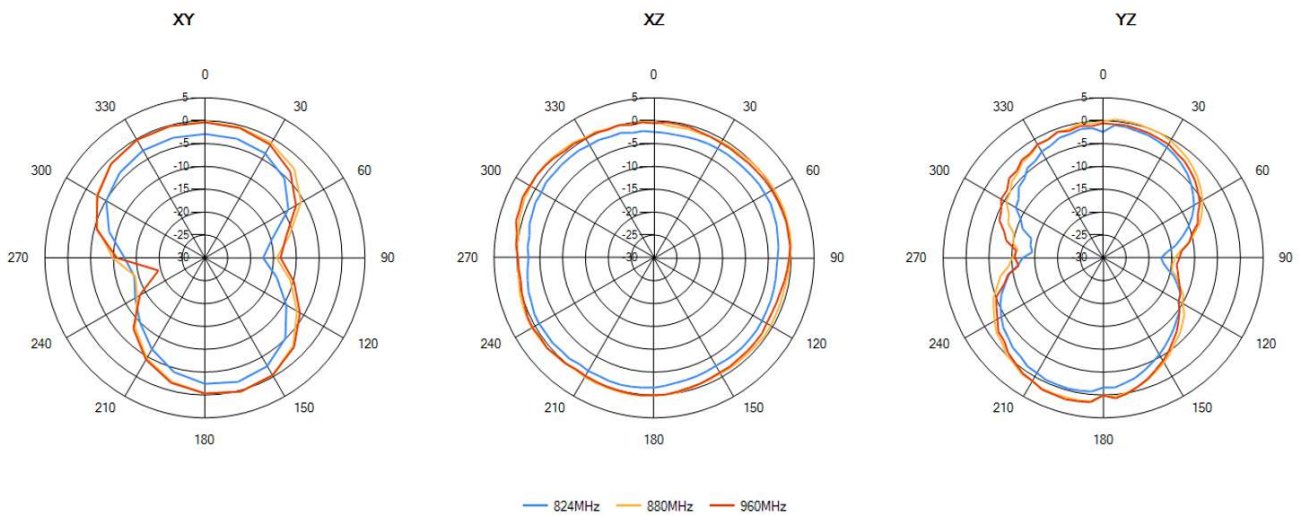

Antennas for Wireless Applications

### 7.3.2 1710 MHz – 2170 MHz

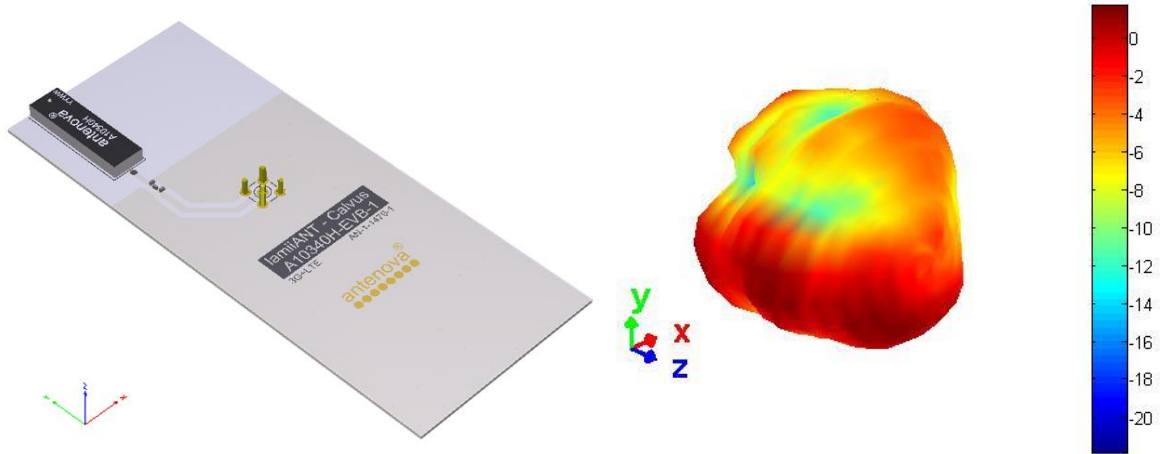

**3D pattern at 1930 MHz**  
Drag to rotate pattern and PCB by using Adobe Reader  
(Click to Activate)

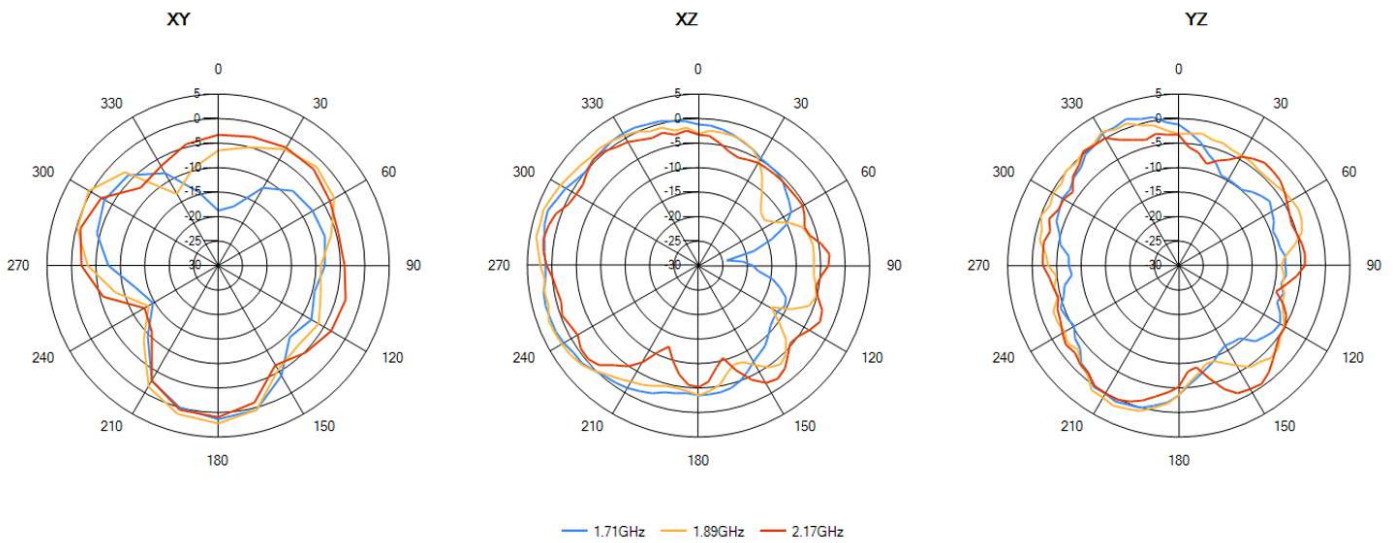

## 8. Antenna Dimensions



Top side

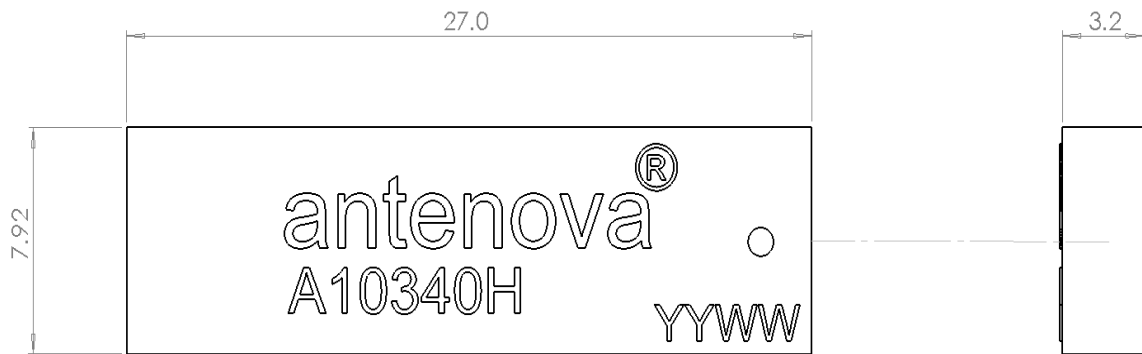

Bottom Side

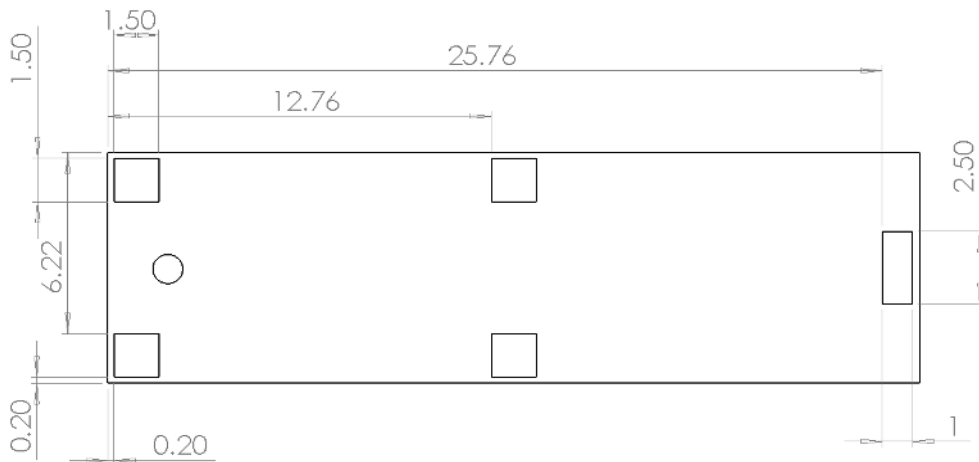

All Dimensions in (mm)

Antennas for Wireless Applications

## 9. Schematic symbol and Pin definition

The circuit symbol for the antenna is shown below. The antenna has five pins with only two as functional. All other pins are for mechanical strength.

Pin	Description
1	Feed
2,3,4,5	Not used (Mechanical only)

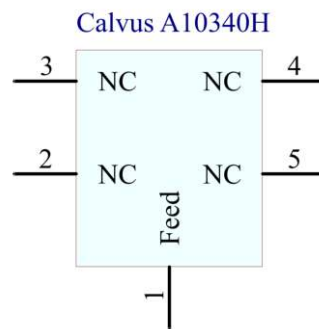

## 10. Antenna footprint

The recommended host PCB footprint is below.

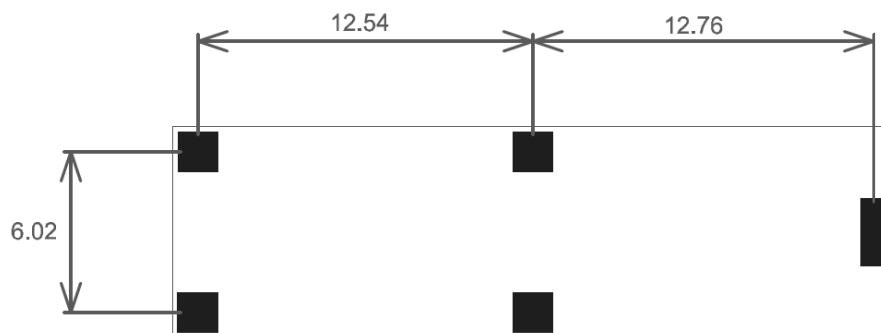

4 copper pads all 1.5 x 1.5 (mm)  
1 copper pad (feed) 2.5 x 1.0 (mm)



## 11. Electrical Interface

### 11.1 Transmission Line

All transmission lines should be designed to have a characteristic impedance of  $50\Omega$ .

- The length of the transmission lines should be kept to a minimum
- Any other parts of the RF system like transceivers, power amplifiers, etc, should also be designed to have an impedance of  $50\Omega$

Once the material for the PCB has been chosen (PCB thickness and dielectric constant), a coplanar transmission line can easily be designed using any of the commercial software packages for transmission line design. For the chosen PCB thickness, copper thickness and substrate dielectric constant, the program will calculate the appropriate transmission line width and gaps on either side of the track so the characteristic impedance of the co-planar transmission is  $50\Omega$ .

### 11.2 Matching Circuit

The antenna requires a matching circuit that must be optimized for each product. The matching circuit will require up to six components and the following circuit should be designed into the host PCB. Not all components may be required but should be included as a precaution. The matching network must be placed close to the antenna feed to ensure it is more effective in tuning the antenna.

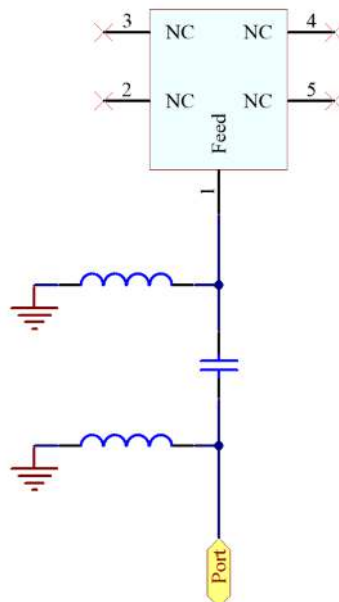

## 12. Antenna Integration Guide

### 12.1 Antenna Placement

Calvus should be fitted to the device so that power from the antenna can radiate into free space. Antenova recommends fitting the antenna close to the corner of the PCB with few components or metal objects nearby. Ground can be placed at the side of the antenna closest to the feed, and it is recommended that any ground either side of the antenna should be at least 15mm away. The area directly above and below should be free from components or conducting objects. Antenova offers a full range of development support to ensure efficient implementation of the antenna into the specific design. To overcome RF design issues, matching circuits, transmission lines, layout and other components, please contact Antenova ([sales@antenova.com](mailto:sales@antenova.com)) for design and placement recommendations.

Two recommended configurations are shown below, but other layouts are possible. In both the distance to the antenna from the GND plane is 5.6mm.

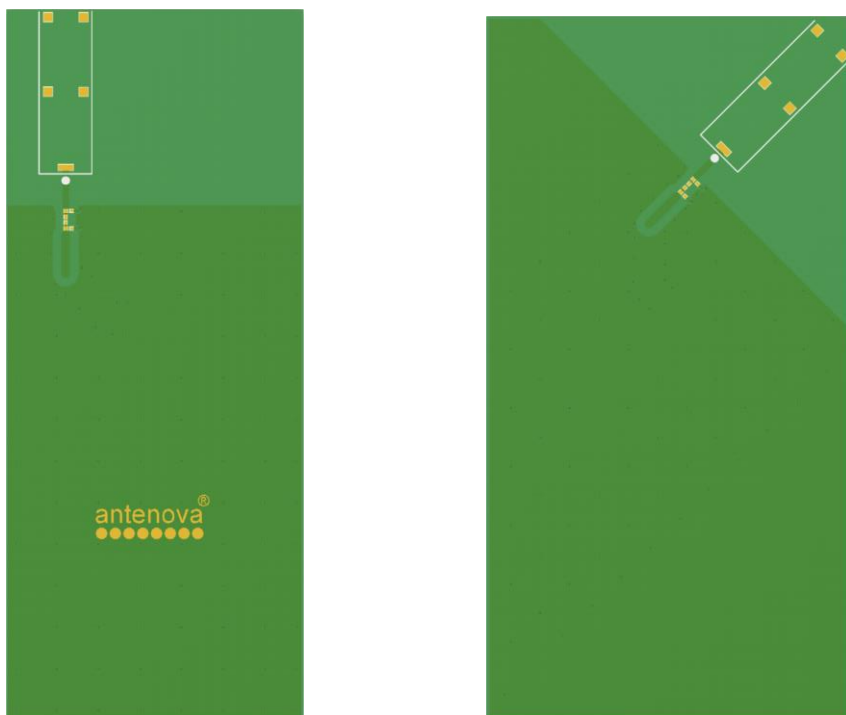

Recommended PCB layouts: antenna mounted straight (left) and at 45 degrees (right).

Antennas for Wireless Applications

## 13.0 Reference Board

The reference board has been designed for the purpose of evaluating A10340H and includes a SMA female connector.

### A10340H Evaluation Board



To order a reference board please see [www.antenna.com](http://www.antenna.com).

Antennas for Wireless Applications

## 13.1 Reference Board Matching Circuit

The reference board has been designed for the purpose of evaluating A10340H and includes an SMA female connector.

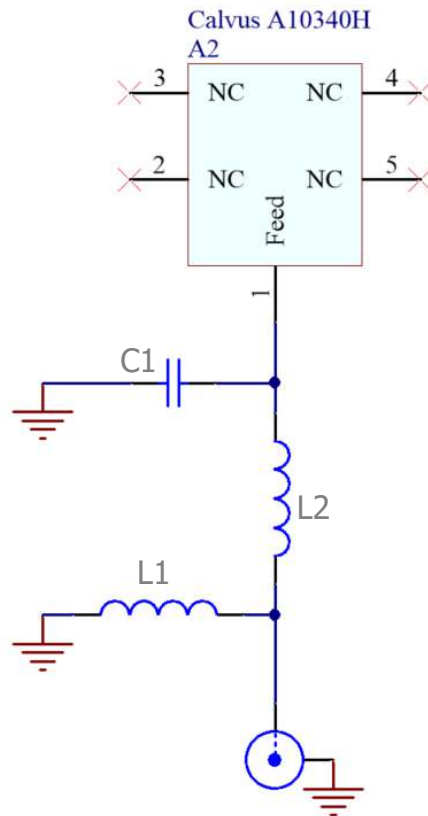

Designator	Type	Value	Description
L1	Inductor	10nH	Murata LQG15HN series
L2	Capacitor	1.8nH	Murata LQG15HN series
C2	Capacitor	1pF	Murata GJM15 series

## 14. Comparison S11

The A10340H is a direct replacement for the A10340 original part. The below is a comparison between each on the same evaluation PCB.

### 14.1 Return Loss

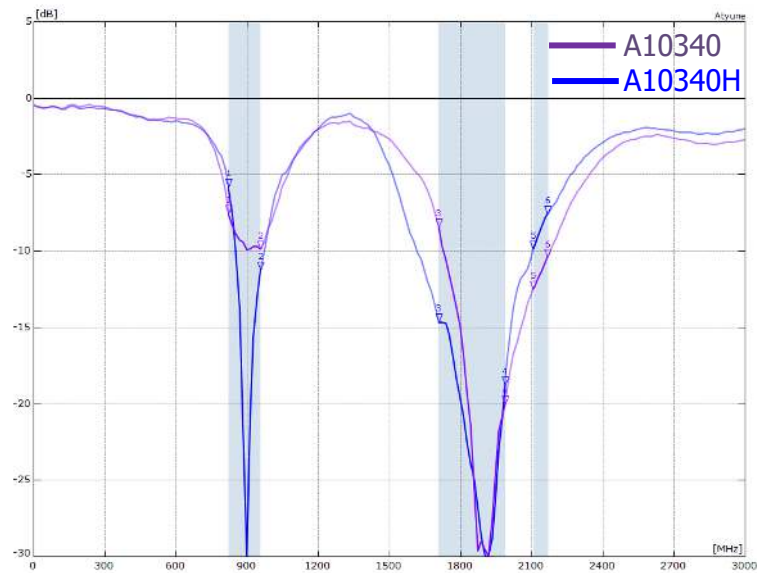

### 14.2 VSWR

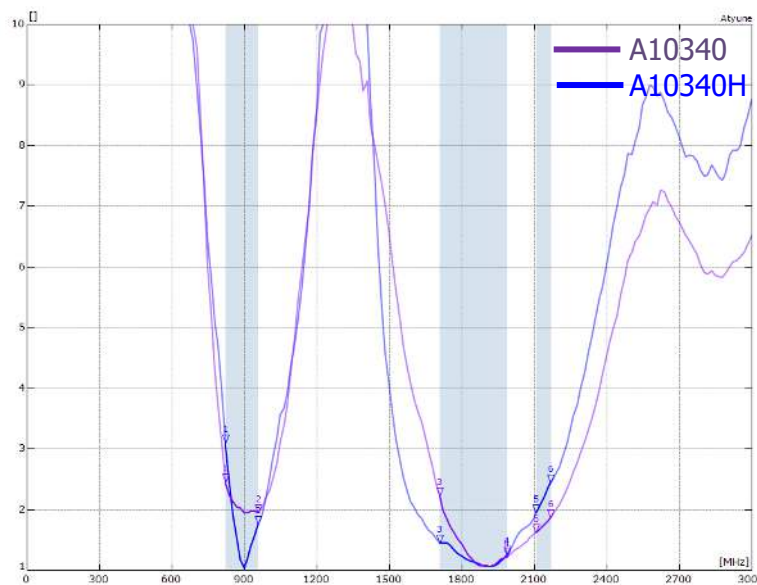

## 15. Soldering

This antenna is suitable for lead free soldering. The reflow profile should be adjusted to suit the device, oven and solder paste, while observing the following conditions:

- The maximum temperature should not exceed 240 °C
- However for lead free soldering, a maximum temperature of 255 °C for no more than 20 seconds is permitted.
- The antenna should not be exposed to temperatures exceeding 120 °C more than 3 times during the soldering process.

## 16. Hazardous Material Regulation Conformance

The antenna has been tested to conform to RoHS requirements. A certificate of conformance is available from Antenova's website.

## 17. Packaging

### 17.1 Optimal Storage Conditions

Temperature	-10°C to 40°C
Humidity	Less than 75% RH
Shelf life	24 Months
Storage place	Away from corrosive gas and direct sunlight
Packaging	Reels should be stored in unopened sealed manufacturer's plastic packaging.

**Note: Storage of open reels of antennas is not recommended due to possible oxidization of pads on antennas. If short term storage is necessary, then it is highly recommended that the bag containing the antenna reel is re-sealed and stored in like storage conditions as in above table.**

## 17.2 Tape Characteristics

Ko	Ao	Bo	P0	P1	P2
3.60	8.90 ± 0.1	35.60 ± 0.1	4.00 ± 0.1	12.00 ± 0.1	2.00 ± 0.1

E1	F	W
1.75 ± 0.1	26.2 ± 0.15	56.00 ± 0.3

Dimensions in mm

**Notes:**

- 1) Material: PS Black – Thickness: 0.35 ±0.05.
- 2) Packaging length per 22” reel: 51 Meters (1:4).
- 3) Component load per 13” reel: 1000pcs

### 17.3 Reel Dimensions

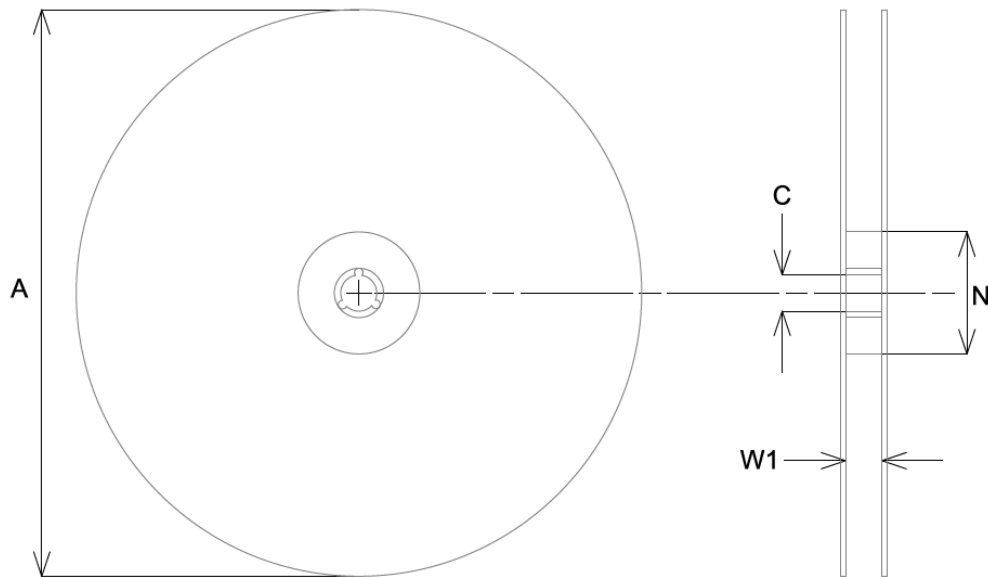

A	C	N	W1
330.0 ± 2.0	13.5 ± 0.5	100.0 ± 0.2	44.4 ± 0.3

All dimensions in mm



## 17.4 Box Dimensions

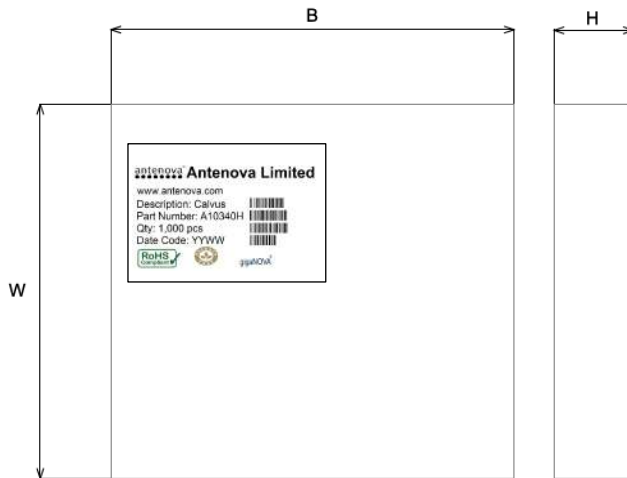

Width (W)	Breadth (B)	Thickness (H)
349mm	351mm	57mm

## 17.5 Bag Properties

Reels are supplied in protective plastic packaging.

## 17.6 Reel Label Information

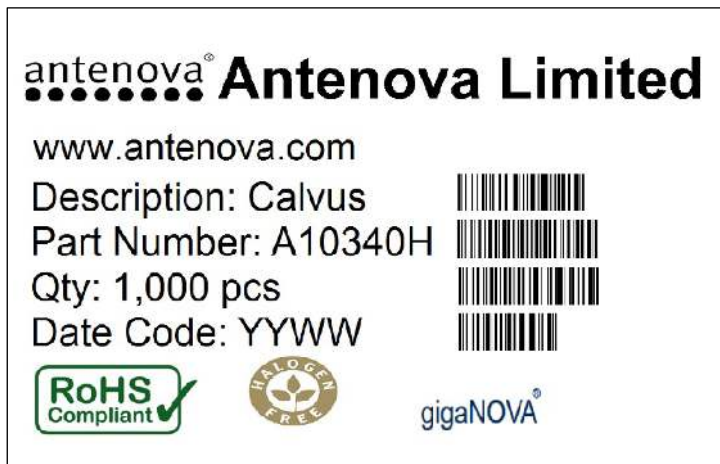

## Quality statements

Antenova's products conform to REACH and RoHS legislation. For our statements regarding these and other quality standards, please see [www.antenova.com](http://www.antenova.com).



## Antenna design, integration and test resources

Product designers – the details contained in this datasheet will help you to complete your embedded antenna design. Please follow our technical advice carefully to obtain optimum antenna performance.

It is our goal that every customer will create a high performing wireless product using Antenova's antennas. You will find a wealth of design resources, calculators and case studies to aid your design at our website.

Antenova's design laboratories are equipped with the latest antenna design tools and test chambers. We provide antenna design, test and technical integration services to help you complete your design and obtain certifications.

If you cannot find the antenna you require in our product range, please contact us to discuss creating a bespoke antenna to meet your requirement exactly.

## Contacts

Join our online antenna design community: [ask.antenova.com](http://ask.antenova.com)

Order antenna samples and evaluation boards at: [www.antenova.com](http://www.antenova.com)

Request a quotation for antennas by volume: [sales@antenova.com](mailto:sales@antenova.com)

Global Headquarters:

**Antenova Ltd, 2<sup>nd</sup> Floor Titan Court, 3 Bishop Square,  
Hatfield, AL10 9NA +44 (0) 1223 810600**

**Copyright® Antenova Ltd.** All Rights Reserved. Antenova®, gigaNOVA®, RADIONOVA®, the Antenova product family names and the Antenova logos are trademarks and/or registered trademarks of Antenova Ltd. Any other names and/or trademarks belong to their respective companies. The materials provided herein are believed to be reliable and correct at the time of printing. Antenova does not warrant the accuracy or completeness of the information, text, graphics or other items contained within this information. Antenova further assumes no responsibility for the use of this information, and all such information shall be entirely at the user's risk.

# Antennas for Wireless Applications