

LTC3355EUF 20V 1A Buck DC/DC with Integrated SCAP Charger and Backup Regulator

DESCRIPTION

Demonstration circuit 2040A is a 12V to 4V/1A regulator with an integrated supercap charger and backup boost regulator featuring the [LTC®3355EUF](#). The LTC3355 charges up a 3F supercapacitor from the output when the 12V input is available. When the 12V input fails, the backup boost regulator supplies the output until the energy in the supercapacitor is depleted. Figure 2 illustrates how long

a 3F supercapacitor can provide a 4W output when the input power fails (~600ms).

Design files for this circuit board are available at <http://www.linear.com/demo>

LT, LT, LTC, LTM, Linear Technology and the Linear logo are registered trademarks of Linear Technology Corporation. All other trademarks are the property of their respective owners.

PERFORMANCE SUMMARY Specifications are at T_A = 25°C

SYMBOL	PARAMETER	CONDITIONS	MIN	TYP	MAX	UNITS
V _{IN}	Input Voltage Range		11.2		13.2	V
V _{OUT}	Output Voltage			4.0		V
V _{CAP}	Supercap Float Voltage			2.4		V
I _{CHRG}	Supercap Charge Current				1.0	A
I _{VOUT}	Output Current	V _{IN} > 10.8V, PFI ≥ 0.8V, V _{OUT} ±1%, I _{CHRG} = 0A			1.0	A

BOARD PHOTO

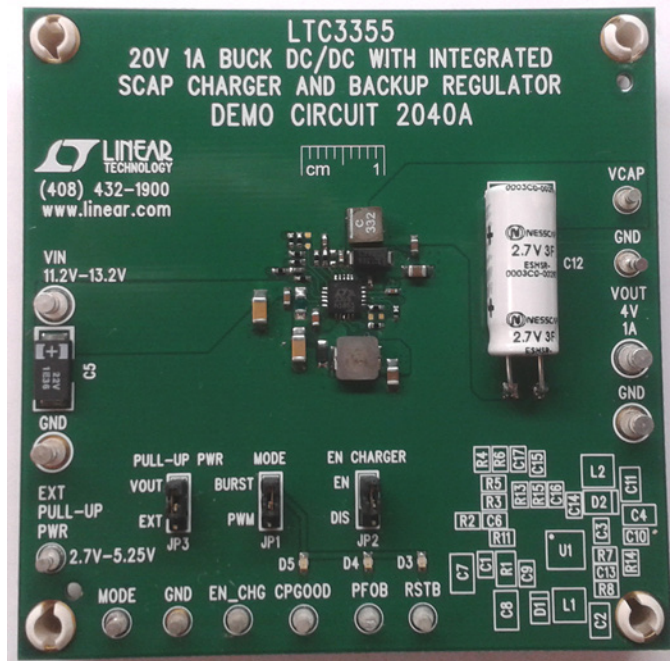

Figure 1

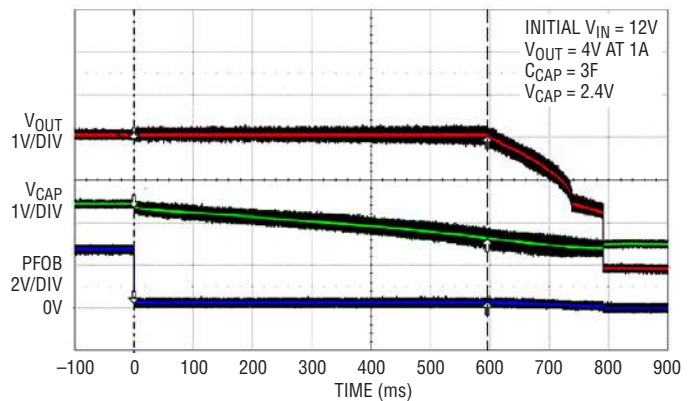

Figure 2. Backup Operation

QUICK START PROCEDURE

Refer to Figure 3 for the proper measurement equipment setup and jumper settings and follow the procedure below.

Note: When measuring the input or output voltage ripple, care must be taken to avoid a long ground lead on the oscilloscope probe. Measure the input or output voltage ripple by touching the probe tip directly across the VIN, VCAP, or VOUTx and GND terminals. See Figure 4 for proper scope probe technique.

1. Make sure the following jumpers are set as described below:
 - MODE jumper, JP1, to the BURST position;
 - EN CHARGER jumper, JP2, to the EN position;
 - PULL-UP PWR jumper, JP3, to the VOUT position.
2. Set PS1 to 0V and LD1 = 0A.
3. Slowly increase PS1 until VIN is equal to 12V. Observe the voltage on VOUT and VCAP. The CPGOOD LED extinguishes as the VCAP voltage approaches the set float voltage.

Note: Without an external supply used for the LED pull-up power, PS2, the CPGOOD, RSTB, or PFOB LEDs will not illuminate until VOUT has enough voltage.

4. Set LD1 to 1A. Observe the voltage on VOUT.
5. With an oscilloscope, connect one probe to the PFOB terminal with the vertical scale set to 2V/Div. Set another probe to the VOUT terminal with the vertical scale set to 1V/Div and set a third probe on the VCAP terminal with the scale set to 1V/Div.
6. Set the horizontal scale to 100ms/Div and set the oscilloscope to trigger on the falling edge of PFOB in "Normal" trigger mode.
7. Turn off PS1 and observe how long the output is maintained with 4W of power. Compare the results to Figure 2.
8. The VOUT and VCAP voltages, the input current limit, charge current and boost peak current can all be re-programmed via resistors. Please refer to the LTC3355 data sheet for more details.

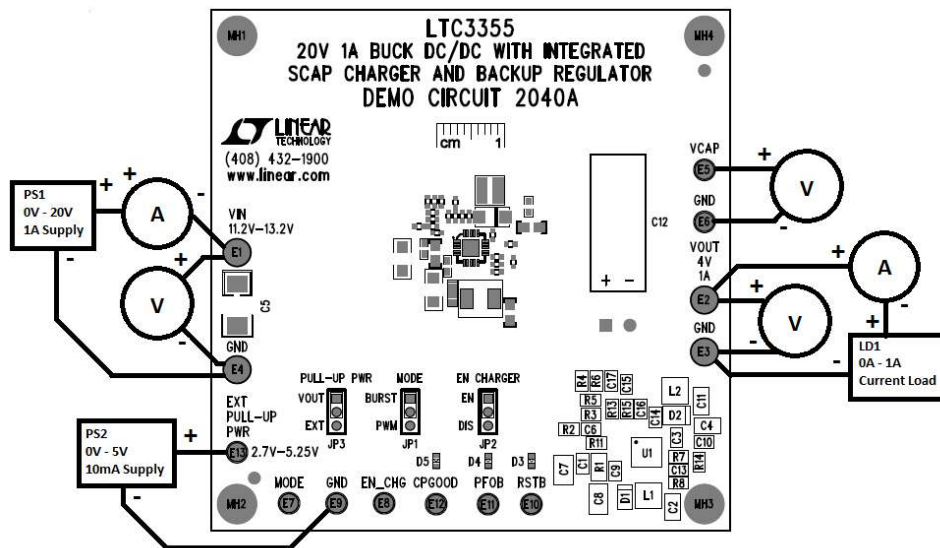

Figure 3. Proper Measurement Equipment Setup for DC1468A

QUICK START PROCEDURE

The MODE, EN_CHG, inputs and RSTB, PFOB, and CPGOOD outputs can be pulled up to VOUT or an external 0V to 5.5V supply. INTV_{CC} is an internal voltage rail and should not be used as an external supply. During start-up, an internal soft-start ramp limits the inrush current. The buck will enter PWM or Burst Mode operation depending on the state of the MODE pin after the buck is in regulation. Then the charger will charge the supercapacitor depending on the state of the EN_CHG pin and the input current limit.

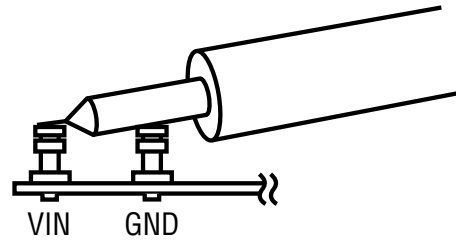

Figure 4. Measuring Input or Output Ripple

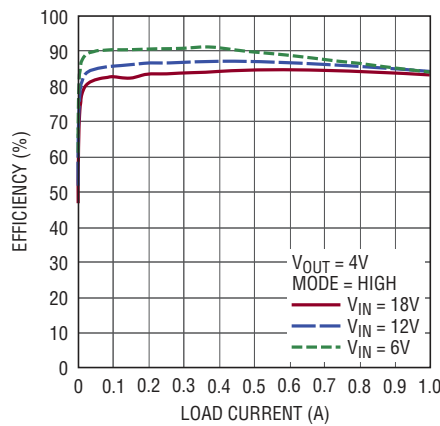

Figure 5. Buck Efficiency

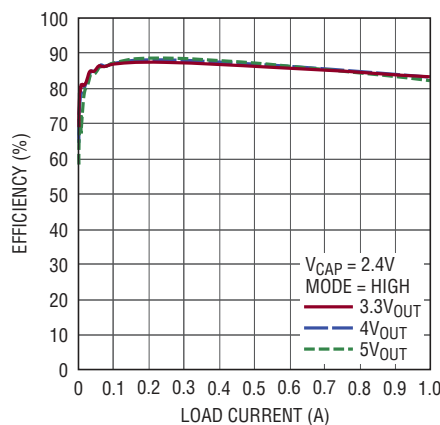

Figure 6. Boost Efficiency

DEMO MANUAL DC2040A

PARTS LIST

ITEM	QTY	REFERENCE	PART DESCRIPTION	MANUFACTURER/PART NUMBER
Required Circuit Components				
1	1	C1	CAP, CHIP, X7R, 0.1 μ F, \pm 10%, 50V, 0603	MURATA, GRM188R71H104K
2	2	C2, C4	CAP, CHIP, 47 μ F, X5R, 6.3V \pm 20%, 0805	TDK, C2012X5R0J476M
3	1	C6	CAP CHIP 4.7pF 50V 5% COG 0402	MURATA, GRM1555C1H4R7JA01D
4	2	C7, C8	CAP, CHIP, X5R, 10 μ F, \pm 10%, 25V, 1206	MURATA, GRMC31R61E106KA12L
5	1	C9	CAP, CHIP, X5R, 1 μ F, \pm 10%, 10V, 0603	TDK, C1608X5R1A105K
6	1	C11	CAP, CHIP, X5R, 10 μ F, 6.3V, \pm 20%, 0603	TDK, C1608X5R0J106M
7	1	C12	CAP SUPER 3F, 2.7V, RADIAL	NESSCAP, ESHSR-0003C0-002R7
8	1	C14	CAP, CHIP, X5R, 1 μ F, \pm 10%, 10V, 0402	MURATA, GRM155R61A105KE15D
9	1	C15	CAP CHIP 220pF 50V 5% COG 0402	MURATA, GRM1555C1H221JA01D
10	1	D1	DIODE, SCHOTTKY, 30V, 1A, TUMD2	ROHM, RSX201VA-30
11	1	D2	DIODE, SCHOTTKY, 30V, 2A, SMA	DIODES INC, B230A-13-F
12	1	L1	IND, SMT, 6.8 μ H, 121m Ω , \pm 20%, 2.1A, 5.2mmx5.5mm	VISHAY, IHLP2020BZER6R8M11
13	1	L2	IND, SMT, 3.3 μ H, 26m Ω , \pm 20%, 5.5A, 4mmx4mm	COILCRAFT, XAL4030-332MEB
14	1	R1	RES, 0.091 Ω \pm 5%, 1/4W, 0805	SUSUMU, RL1220T-R091-J
15	1	R3	RES, CHIP, 402k, \pm 1%, 1/10W, 0402	VISHAY, CRCW0402402KFKED
16	1	R4	RES, CHIP, 2.49M, \pm 1%, 1/16W, 0402	VISHAY, CRCW04022M49FKED
17	1	R5	RES, CHIP, 100k, \pm 1%, 1/16W, 0402	VISHAY, CRCW0402100KFKED
18	2	R6, R13	RES, CHIP, 200k, \pm 1%, 1/16W, 0402	VISHAY, CRCW0402200KFKED
19	1	R7	RES, CHIP, 665k, \pm 1%, 1/16W, 0402	VISHAY, CRCW0402665KFKED
20	1	R8	RES, CHIP, 332k, \pm 1%, 1/16W, 0402	VISHAY, CRCW0402332KFKED
21	1	R14	RES, CHIP, 60.4k, \pm 1%, 1/10W, 0402	VISHAY, CRCW040260K4FKED
22	1	R15	RES, CHIP, 154k, \pm 1%, 1/16W, 0402	VISHAY, CRCW0402154KFKTD
23	1	U1	20V 1A BUCK DC/DC WITH INTEGRATED SCAP CHARGER AND BACKUP REGULATOR	LINEAR TECH., LTC3355EUF
Additional Demo Board Circuit Components				
24	2	C3, C10	CAP, CHIP, X5R, 0.1 μ F, \pm 10%, 16V, 0402	MURATA, GRM155R71C104KA88
25	1	C5	CAP, CHIP, POSCAP, 22 μ F, \pm 10%, 25V, SMT	SANYO, 25TQC22M
26	0	C13, C16, C17	CAP CHIP, 0402	
27	3	D3-D5	LED 660NM SUPER RED DIFF 0603 SMD	LUMEX, SML-LX0603SRW-TR
28	1	R2	RES, CHIP, 20 Ω , \pm 1%, 1/16W, 0402	VISHAY, CRCW040220R0FKED
29	2	R9, 10	RES, CHIP, 1k, \pm 5%, 1/16W, 0402	VISHAY, CRCW04021K00JNED
30	2	R11, R12	RES, CHIP, 1.00Mk, \pm 5%, 1/16W, 0402	VISHAY, CRCW04021M00JNED
31	3	R16, R17, R18	RES, CHIP, 2k, \pm 5%, 1/16W, 0402	VISHAY, CRCW04022K00JNED
Hardware-For Demo Board Only				
32	4	E1, E2, E3, E4	TURRET, 0.09 DIA	MILL-MAX, 2501-2-00-80-00-00-07-0
33	9	E5-E13	TURRET, 0.061 DIA	MILL-MAX, 2308-2-00-80-00-00-07-0
34	3	JP1-JP3	HEADER, 3-PIN 0.079 SINGLE ROW	SULLINS, NRPN031PAEN-RC
35	3	JP1-JP3	SHUNT, 2mm	SAMTEC, 2SN-BK-G
36	0.00788		SCOTCH, REMOVABLE POSTER TAPE W/DISPENSER, 75" x 150"	3M, MMM109
37	4		STAND-OFF NYLON, 0.375" TALL (SNAP-ON)	KEystone, 8832 (SNAP ON)

SCHEMATIC DIAGRAM

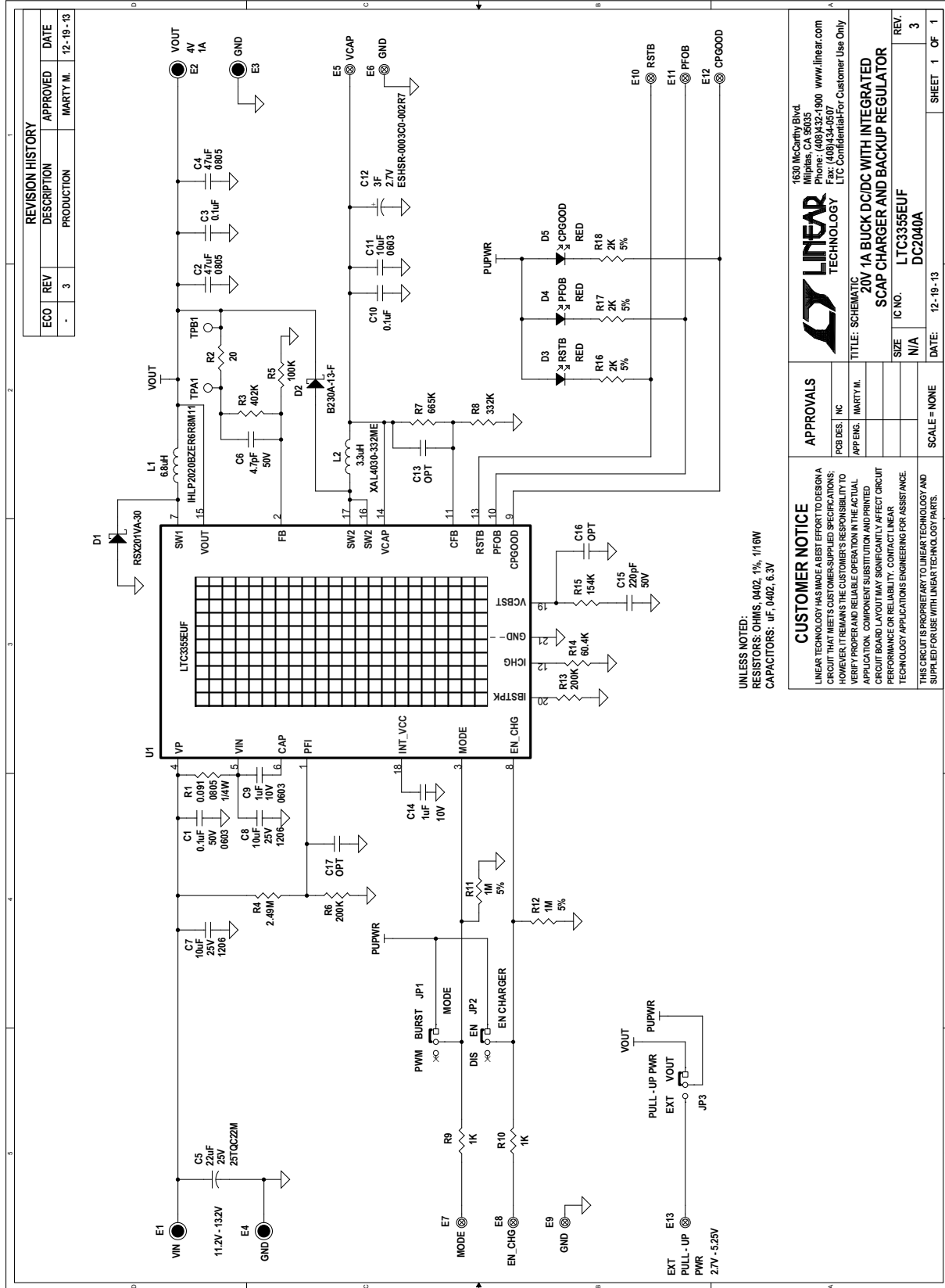

REVISION HISTORY				
ECO	REV	DESCRIPTION	APPROVED	DATE
-	3	PRODUCTION	MARTY M.	12-19-13

UNLESS NOTED:
RESISTORS: OHMS, 0402, 1%, 1/16W
CAPACITORS: µF, 0402, 6.3V

CUSTOMER NOTICE
LINEAR TECHNOLOGY HAS MADE A BEST EFFORT TO DESIGN A CIRCUIT THAT MEETS CUSTOMER-SUPPLIED SPECIFICATIONS; HOWEVER, IT REMAINS THE CUSTOMER'S RESPONSIBILITY TO VERIFY PROPER AND RELIABLE OPERATION IN THE ACTUAL APPLICATION. COMPONENT SUBSTITUTION AND PRINTED CIRCUIT BOARD LAYOUT MAY SIGNIFICANTLY AFFECT CIRCUIT PERFORMANCE OR RELIABILITY. CONTACT LINEAR TECHNOLOGY APPLICATIONS ENGINEERING FOR ASSISTANCE.
THIS CIRCUIT IS PROPRIETARY TO LINEAR TECHNOLOGY AND SUPPLIED FOR USE WITH LINEAR TECHNOLOGY PARTS.

APPROVALS	
P.C.B. DES.	INC
APP'NG.	MARTY M.

1630 McCarthy Blvd. Milpitas, CA 95035 Phone: (408)432-1900 www.linear.com Fax: (408)434-0507 LTC Confidential/For Customer Use Only	
TITLE: SCHEMATIC 20V 1A BUCK DC/DC WITH INTEGRATED SCAP CHARGER AND BACKUP REGULATOR	
SIZE	IC NO. LTC3355EUF
REV.	3
DATE: 12-19-13	SHEET 1 OF 1



Information furnished by Linear Technology Corporation is believed to be accurate and reliable. However, no responsibility is assumed for its use. Linear Technology Corporation makes no representation that the interconnection of its circuits as described herein will not infringe on existing patent rights.

DEMO MANUAL DC2040A

DEMONSTRATION BOARD IMPORTANT NOTICE

Linear Technology Corporation (LTC) provides the enclosed product(s) under the following **AS IS** conditions:

This demonstration board (DEMO BOARD) kit being sold or provided by Linear Technology is intended for use for **ENGINEERING DEVELOPMENT OR EVALUATION PURPOSES ONLY** and is not provided by LTC for commercial use. As such, the DEMO BOARD herein may not be complete in terms of required design-, marketing-, and/or manufacturing-related protective considerations, including but not limited to product safety measures typically found in finished commercial goods. As a prototype, this product does not fall within the scope of the European Union directive on electromagnetic compatibility and therefore may or may not meet the technical requirements of the directive, or other regulations.

If this evaluation kit does not meet the specifications recited in the DEMO BOARD manual the kit may be returned within 30 days from the date of delivery for a full refund. **THE FOREGOING WARRANTY IS THE EXCLUSIVE WARRANTY MADE BY THE SELLER TO BUYER AND IS IN LIEU OF ALL OTHER WARRANTIES, EXPRESSED, IMPLIED, OR STATUTORY, INCLUDING ANY WARRANTY OF MERCHANTABILITY OR FITNESS FOR ANY PARTICULAR PURPOSE. EXCEPT TO THE EXTENT OF THIS INDEMNITY, NEITHER PARTY SHALL BE LIABLE TO THE OTHER FOR ANY INDIRECT, SPECIAL, INCIDENTAL, OR CONSEQUENTIAL DAMAGES.**

The user assumes all responsibility and liability for proper and safe handling of the goods. Further, the user releases LTC from all claims arising from the handling or use of the goods. Due to the open construction of the product, it is the user's responsibility to take any and all appropriate precautions with regard to electrostatic discharge. Also be aware that the products herein may not be regulatory compliant or agency certified (FCC, UL, CE, etc.).

No License is granted under any patent right or other intellectual property whatsoever. **LTC assumes no liability for applications assistance, customer product design, software performance, or infringement of patents or any other intellectual property rights of any kind.**

LTC currently services a variety of customers for products around the world, and therefore this transaction **is not exclusive**.

Please read the DEMO BOARD manual prior to handling the product. Persons handling this product must have electronics training and observe good laboratory practice standards. **Common sense is encouraged.**

This notice contains important safety information about temperatures and voltages. For further safety concerns, please contact a LTC application engineer.

Mailing Address:

Linear Technology
1630 McCarthy Blvd.
Milpitas, CA 95035

Copyright © 2004, Linear Technology Corporation