



THIS INFORMATION IS CONFIDENTIAL AND PROPRIETARY TO CW INDUSTRIES INCORPORATED AND ITS AFFILIATES. IT MAY NOT BE DISCLOSED TO ANYONE, OTHER THAN CW INDUSTRIES PERSONNEL, WITHOUT WRITTEN AUTHORIZATION FROM CW INDUSTRIES INCORPORATED, SOUTHAMPTON, PENNSYLVANIA USA.

Rating	12(4)A 250V ac   c  US	Mounting Hole	Circuit Diagram
Contact Resistance	50m ohm Max.		
Insulation Resistance	DC 500V 100M ohm Min.		
Dielectric Strength	AC 1500V 1 minute		
Switch Function	6P DPDT ON-ON		
Operation Temperature	0°0~85°C		

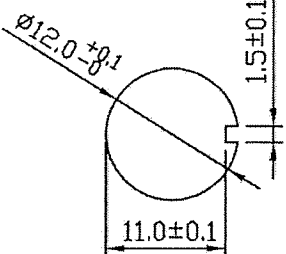
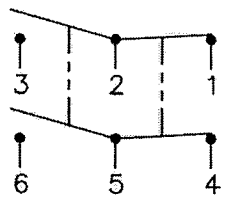
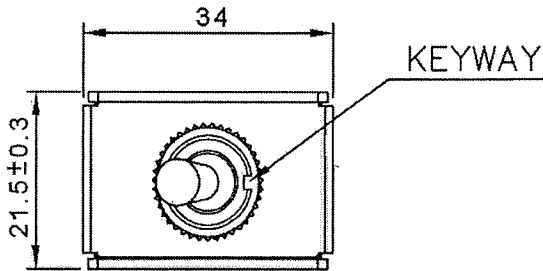

MATERIAL:
 Frame: Nylon 6/6, Black
 UL Flame: 94-V0
 Lever: Metal
 Terminal: Copper Alloy

Water proof and Dust Proof
 to fit IP-56

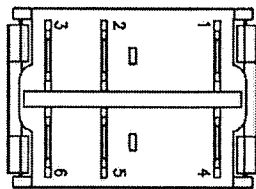
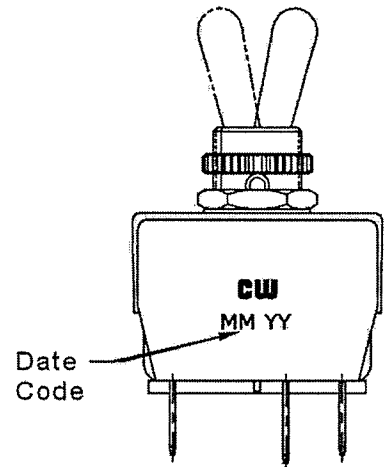
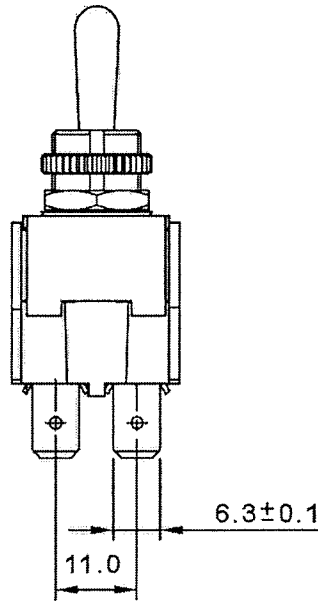
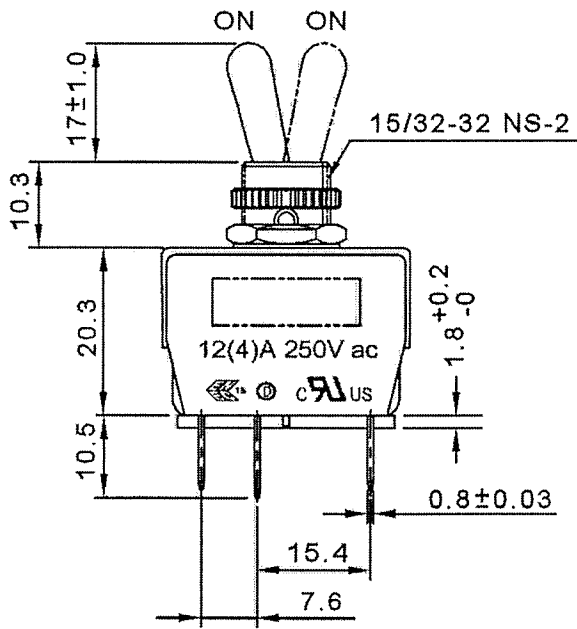

Tolerances Unless Otherwise Specified +/-0.5.

RoHS Compliant

5 Updated views, Materials & dimensions. 3-06-13.

CW INDUSTRIES
 Southampton, Pa. 18966
 Tel 215.355.7080/www.cwind.com

Date Drawn: 1/28/11

Rev. 5

Unit: mm

Checked By: *G. Guld*

Title:
TOGGLE SWITCH

CW P/N:
GTS448B101A1HR