



Connectors > Power Connectors > Circular Power > Circular Power Connectors



Connector Product Type: **Housing**

Operating Voltage: **600 VDC**

Connector System: **Wire-to-Wire**

Number of Positions: **24**

Sealable: **Yes**

## Features

### Product Type Features

Connector Seal & Plug Type	Elastomer Seal
Connector Product Type	Housing
Connector System	Wire-to-Wire
Sealable	Yes
Connector & Contact Terminates To	Wire & Cable
Connector & Housing Type	Plug
Circular Connector Shell Type	All Plastic

### Configuration Features

Reverse Numbering	Without
Number of Positions	24
Number of Power Positions	0
Number of Signal Positions	24

### Electrical Characteristics

Operating Voltage	600 VAC
-------------------	---------



### Contact Features

Reverse Gender	No
Contact Type	Socket
Contact Protection	With

### Mechanical Attachment

Mating Alignment Type	Keyed
Mating Alignment	With
Mating Retention Type	Threaded Coupling
Thread Size	1-3/8 - 18 UNEF-2A
Polarization Code	A
Connector Mounting Type	Cable Mount (Free-Hanging)
Mating Retention	With
Panel Mount Feature	Without

### Housing Features

Body Orientation	Straight
Housing Color	Black
Housing Material	Nylon 6/6 GF
Circular Connector Shell Size	23

### Usage Conditions

Operating Temperature Range	-55 – 105 °C[-67 – 221 °F]
Fluid Resistance	None

### Operation/Application

Circuit Application	Power & Signal
Shielded	No

### Industry Standards

UL Flammability Rating	UL 94V-0
------------------------	----------

### Packaging Features

Packaging Quantity	100
Packaging Method	Bag

### Product Compliance

[For compliance documentation, visit the product page on TE.com>](#)



EU RoHS Directive 2011/65/EU	Compliant
EU ELV Directive 2000/53/EC	Compliant
China RoHS 2 Directive MIIT Order No 32, 2016	No Restricted Materials Above Threshold
EU REACH Regulation (EC) No. 1907/2006	Current ECHA Candidate List: JUNE 2023 (235) Candidate List Declared Against: JAN 2023 (233) Does not contain REACH SVHC
Halogen Content	BFR/CFR/PVC Free, but Br/Cl >900 ppm in other sources.
Solder Process Capability	Not applicable for solder process capability

Product Compliance Disclaimer

This information is provided based on reasonable inquiry of our suppliers and represents our current actual knowledge based on the information they provided. This information is subject to change. The part numbers that TE has identified as EU RoHS compliant have a maximum concentration of 0.1% by weight in homogenous materials for lead, hexavalent chromium, mercury, PBB, PBDE, DBP, BBP, DEHP, DIBP, and 0.01% for cadmium, or qualify for an exemption to these limits as defined in the Annexes of Directive 2011/65/EU (RoHS2). Finished electrical and electronic equipment products will be CE marked as required by Directive 2011/65/EU. Components may not be CE marked. Additionally, the part numbers that TE has identified as EU ELV compliant have a maximum concentration of 0.1% by weight in homogenous materials for lead, hexavalent chromium, and mercury, and 0.01% for cadmium, or qualify for an exemption to these limits as defined in the Annexes of Directive 2000/53/EC (ELV). Regarding the REACH Regulation, the information TE provides on SVHC in articles for this part number is based on the latest European Chemicals Agency (ECHA) 'Guidance on requirements for substances in articles' posted at this URL: <https://echa.europa.eu/guidance-documents/guidance-on-reach>

### Compatible Parts



TE Part # CAT-AM71-C83998F  
Connectors with Posted Pin Contacts, CPC Series 1



TE Part # CAT-AM71-C83998J  
Cable/Panel Mount Connector, CPC Series 1



TE Part # 206838-3  
CPC RECPT SEALED SIZE 23-24



TE Part # 206838-4  
CPC RECPT SEALED SIZE 23-24

### Also in the Series | AMP CPC



Circular Connector Adapters(7)

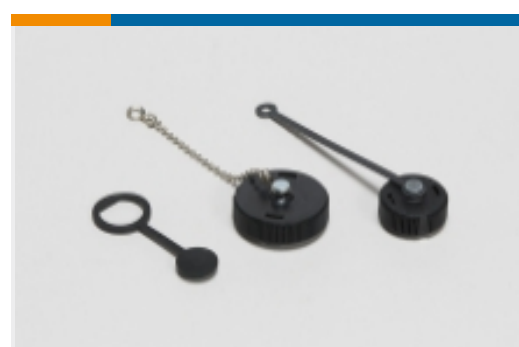

Circular Connector Caps & Covers(16)



Circular Connector Hardware(3)



Circular Connector Keying Plugs(2)



Circular Connector Seals(36)



Circular Power Connectors(459)



Connector Backshells(56)



Connector Strain Relief(6)



Insertion & Extraction Tools(1)

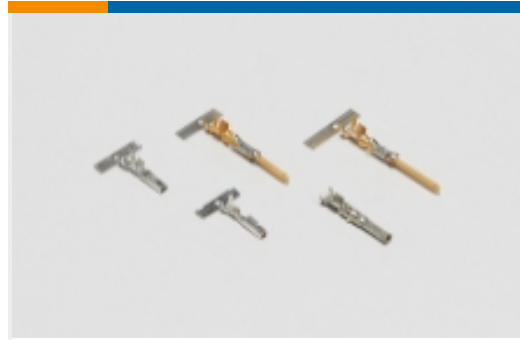

Power Contacts(6)

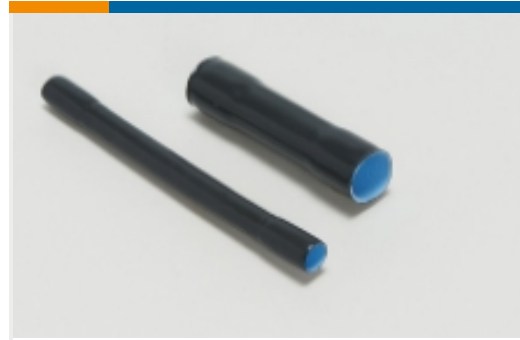

Sealing Sleeves(2)

### Customers Also Bought



TE Part #206838-3  
CPC RECPT SEALED SIZE 23-24



TE Part #206838-1  
23-24 RECEPT

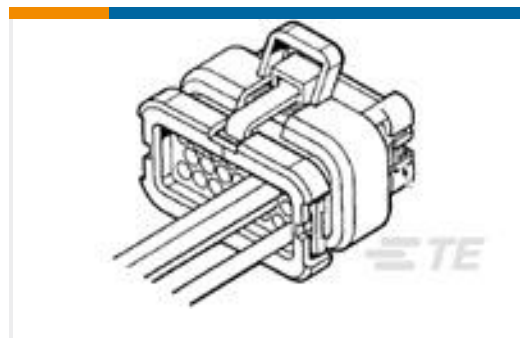

TE Part #776164-6  
35POS,AMPSEAL,SOC HSG ASSY,SLD, COD 6



TE Part #WM-2PA  
WEDGE LOCK, 2P, REC, GRY, DTM, A COD 6



TE Part #DTM04-2P-E003  
DEUTSCH DTM Housings



TE Part #EEC-5X650A  
ENCLOSURE, 5 X 6.50, BLK, VENT



TE Part #2106124-2  
Contact, Tab, Tin Plated, Std Lgth



TE Part #2106136-4  
Assembly, Receptacle, 4-Position



TE Part #2106056-8  
Assembly, Right Angle SMT Header, 4-Posi

### Documents



**Product Drawings**

**CPC PLUG ASSEMBLY SIZE 23-24**

English

---

**CAD Files**

**3D PDF**

3D

**Customer View Model**

[ENG\\_CVM\\_CVM\\_206837-3\\_H.2d\\_dxf.zip](#)

English

**Customer View Model**

[ENG\\_CVM\\_CVM\\_206837-3\\_H.3d\\_igs.zip](#)

English

**Customer View Model**

[ENG\\_CVM\\_CVM\\_206837-3\\_H.3d\\_stp.zip](#)

English

**3D PDF**

English

**Customer View Model**

[ENG\\_CVM\\_206837-3\\_G1.2d\\_dxf.zip](#)

English

**Customer View Model**

[ENG\\_CVM\\_206837-3\\_G1.3d\\_igs.zip](#)

English

**Customer View Model**

[ENG\\_CVM\\_206837-3\\_G1.3d\\_stp.zip](#)

English

By downloading the CAD file I accept and agree to the [Terms and Conditions](#) of use.

---

**Product Specifications**

**Application Specification**

English

---

**Agency Approvals**

**UL Report**

English