

## AHM Series



- IT & Medical Approvals
- Energy Efficiency Level V, CEC2008 & EISA 2007
- <0.5 W No Load Input Power
- Class I and Class II Models (Except AHM250)
- Very High Efficiency
- IP22 Environmental Rating
- 3 Year Warranty

## Specification

## Input

|                       |  |
|-----------------------|--|
| Input Voltage         | • 80-264 VAC (see derating curve)  |
| Input Frequency       | • 47-63 Hz   |
| Input Current         | • 85 W: 0.8 A at 115 VAC, 0.4 A<br>100 W: 1.0 A at 115 VAC, 0.5 A<br>150 W: 1.5 A at 115 VAC, 0.75 A<br>180 W: 1.7 A at 115 VAC, 0.9 A<br>250 W: 2.3 A at 115 VAC, 0.9 A at 230 VAC                |
| Inrush Current        | • 70 A typical, 120 A max at 230 VAC, cold start at 25 °C  |
| Power Factor          | • >0.9 at 115 VAC, 60 Hz at 250 VAC  |
| Earth Leakage Current | • 85 W: 70 µA typical, 180 µA max<br>100 W: 70 µA typical, 180 µA max<br>150 W: 80 µA typical, 200 µA max<br>180 W: 80 µA typical, 200 µA max<br>250 W: 80 µA typical, 200 µA max at 264 VAC/60 Hz |
| Input Protection      | • 85 W: Internal T2.5 A/250 V<br>100 W: Internal T2.5 A/250 V<br>150 W: Internal T4.0 A/250 V<br>180 W: Internal T4.0 A/250 V<br>250 W: Internal T6.3 A/250 V fuse in line and neutral             |
| No Load Input Power   | • <0.5 W   |

## Output

|                            |  |
|----------------------------|--|
| Output Voltage             | • See tables   |
| Output Voltage Trim        | • Not user-adjustable  |
| Minimum Load               | • No minimum load required   |
| Start Up Delay             | • 100-300 ms typical, model dependant <sup>(1)</sup>                       |
| Hold Up Time               | • 20 ms typical  |
| Line Regulation            | • ±1.5% maximum  |
| Load Regulation            | • ±3.0% maximum  |
| Transient Response         | • 5% max. deviation, recovery to within 1% in 500 µs for a 25% load change |
| Ripple & Noise             | • Typically less than 1%, 1.5% max pk-pk <sup>(2)</sup>                    |
| Overvoltage Protection     | • 125% typical, Recycle input to reset                                     |
| Overtemperature Protection | • Unit shuts down, auto recovery   |
| Overload Protection        | • 115-175%, auto recovery  |
| Short Circuit Protection   | • Trip and restart (hiccup mode)   |
| Temperature Coefficient    | • 0.05 %/°C  |

## General

|                     |  |
|---------------------|--|
| Efficiency          | • 92% typical  |
| Energy Efficiency   | • Level V  |
| Isolation           | • 4000 VAC In to Out, 2 x MOPP<br>1500 VAC In to Earth, 1 x MOPP<br>500 VAC Out to Earth, 1 x MOPP |
| Switching Frequency | • 45-200 KHz variable  |
| Power Density       | • 4.4-5.7 W/in <sup>3</sup>  |
| MTBF                | • 153 kHrs typical to MIL-HDBK-217F at 25 °C, GB   |

## Environmental

|                       |  |
|-----------------------|--|
| Operating Temperature | • 0 °C to +60 °C, derate linearly from 100% power at +40 °C to 60% power at +60 °C                 |
| Cooling               | • Convection-cooled  |
| Operating Humidity    | • 5-95% RH, non-condensing   |
| Storage Temperature   | • -40 °C to +85 °C   |
| Operating Altitude    | • 3000 m   |
| Shock                 | • 3 x 30 g/11 ms shocks in both +ve & -ve directions along the 3 orthogonal axis, total 18 shocks. |
| Vibration             | • Three axis 5-500 Hz at 2 g x 10 sweeps   |

## EMC &amp; Safety

|                      |   |
|----------------------|---|
| Emissions            | • EN55011/32, class B conducted<br>EN55011/32, class B radiated   |
| Harmonic Currents    | • EN61000-3-2, class A  |
| Voltage Flicker      | • EN61000-3-3   |
| ESD Immunity         | • EN61000-4-2, level 3, Perf Criteria A   |
| Radiated Immunity    | • EN61000-4-3, level 3, Perf Criteria A   |
| EFT/Burst            | • EN61000-4-4, level 3, Perf Criteria A   |
| Surge                | • EN61000-4-5, installation class 3, Perf Criteria A  |
| Conducted Immunity   | • EN61000-4-6, level 3, Perf Criteria A   |
| Magnetic Field       | • EN61000-4-8, level 3, Perf Criteria A   |
| Dips & Interruptions | • EN61000-4-11, EN60601-1-2   |
| Safety Approvals     | • EN60601-1, ANSI/AAMI ES60601-1, CSA22.2 No. 60601-1 per cUL, Including Risk Management, EN62368-1, UL62368-1. Denan (PSE) certification |

## Notes

1. See longform datasheet for further information.
2. Measured at the end of the output cable with 10 µF electrolytic and 0.1 µF ceramic capacitor.

## Models and Ratings

| Output Power | Output Voltage | Output Current | Model Number <sup>(1)</sup> |
|--------------|----------------|----------------|-----------------------------|
| 85 W         | 12.0VDC        | 7.08 A         | AHM85PS12                   |
| 85 W         | 15.0VDC        | 5.67 A         | AHM85PS15                   |
| 85 W         | 19.0VDC        | 4.47 A         | AHM85PS19                   |
| 85 W         | 24.0VDC        | 3.54 A         | AHM85PS24                   |
| 85 W         | 12.0VDC        | 7.08 A         | AHM85PS12C2                 |
| 85 W         | 15.0VDC        | 5.67 A         | AHM85PS15C2                 |
| 85 W         | 19.0VDC        | 4.47 A         | AHM85PS19C2                 |
| 85 W         | 24.0VDC        | 3.54 A         | AHM85PS24C2                 |

### Notes

1. Models with suffix 'C2' have a Class II equipment protection classification.
2. For IEC320-C8 input connector with Class II models, add suffix '-8' to the model number, e.g. AHM85PS24C2-8.
3. For optional input connector retention clip, add suffix '-A' to the model number e.g. AHM85PS24-A, not available for C8 connectors.
4. Alternate case colours available for OEM quantities, contact sales for information.

## Mechanical Details

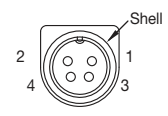
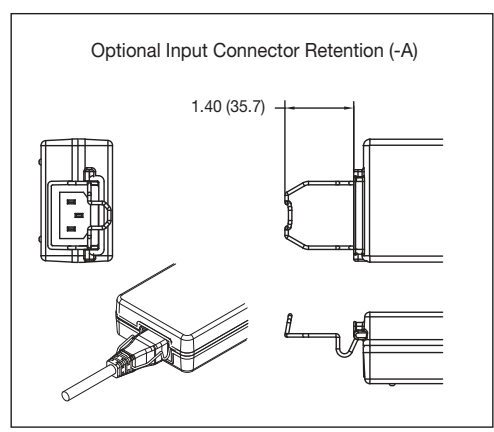
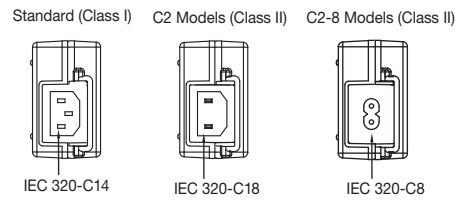
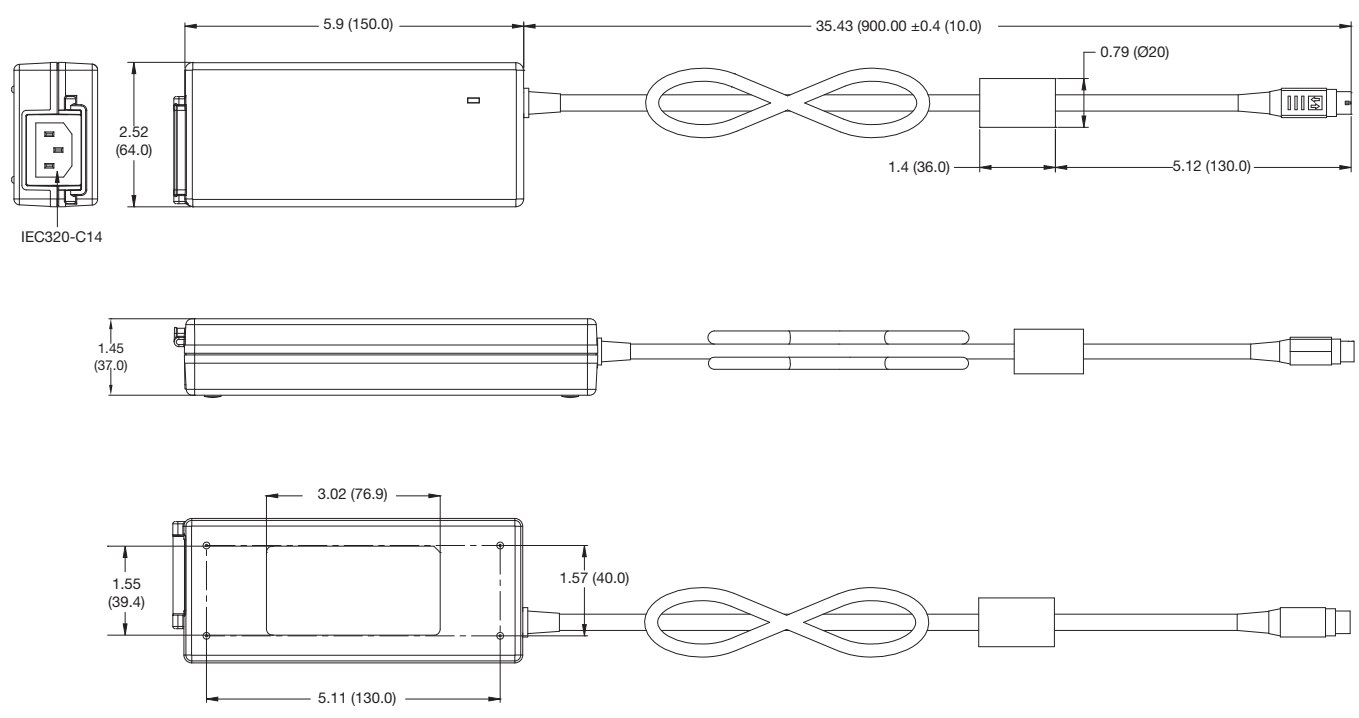

| Output Connector equivalent to KPPX-4P (Non Locking) |          |
|--|----------|
| Pin 1  | Output + |
| Pin 2  | Output + |
| Pin 3  | Return   |
| Pin 4  | Return   |
| Outer Shell  | GND*     |
| Outer Shell C2 Models                                | Floating |

\* Functional earth.

### Notes

1. Tolerance is 0.02 (0.5) maximum, except output cable length.
2. Weight 0.9 lbs (400 g).
3. Dimensions shown in inches (mm).
4. Alternate case colours available for OEM quantities, contact sales for information.



Models and Ratings

| Output Power | Output Voltage | Output Current | Model Number <sup>(1)</sup> |
|--------------|----------------|----------------|-----------------------------|
| 100 W        | 12.0 VDC       | 8.33 A         | AHM100PS12                  |
| 100 W        | 15.0 VDC       | 6.67 A         | AHM100PS15                  |
| 100 W        | 19.0 VDC       | 5.26 A         | AHM100PS19                  |
| 100 W        | 24.0 VDC       | 4.16 A         | AHM100PS24                  |
| 100 W        | 48.0 VDC       | 2.08 A         | AHM100PS48                  |
| 100 W        | 12.0 VDC       | 8.33 A         | AHM100PS12C2                |
| 100 W        | 15.0 VDC       | 6.67 A         | AHM100PS15C2                |
| 100 W        | 19.0 VDC       | 5.26 A         | AHM100PS19C2                |
| 100 W        | 24.0 VDC       | 4.16 A         | AHM100PS24C2                |
| 100 W        | 48.0 VDC       | 2.08 A         | AHM100PS48C2                |

Notes

1. Models with suffix 'C2' have a class II equipment protection classification.
2. For IEC320-C8 input connector with class II models, add suffix '-8' to the model number, e.g. AHM100PS24C2-8.
3. For optional input connector retention clip, add suffix '-A' to the model number e.g. AHM100PS24-A, not available for C8 connectors.
4. Alternate case colours available for OEM quantities, contact sales for information.

Mechanical Details

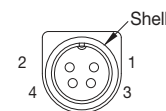
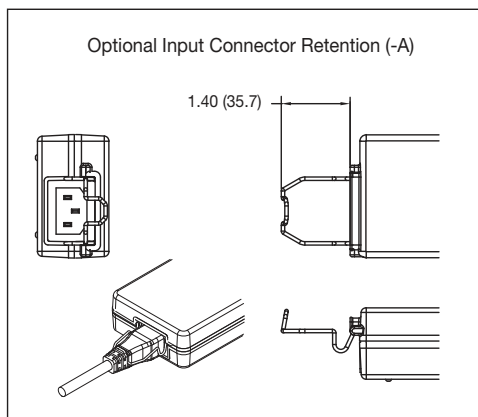
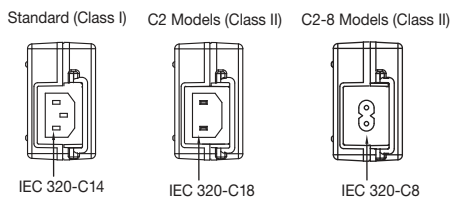
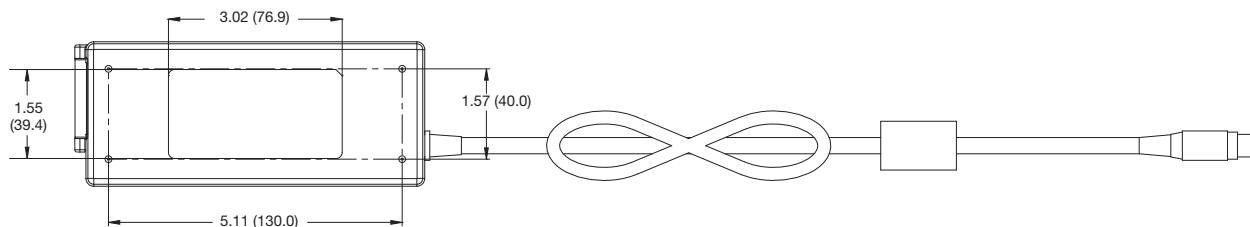
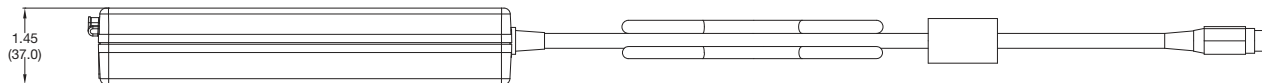
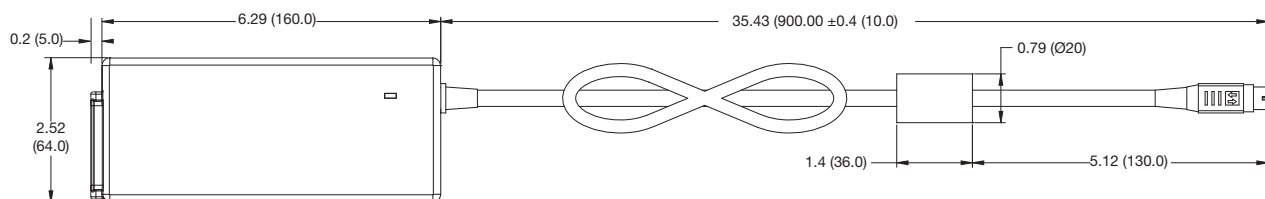

| Output Connector equivalent to KPPX-4P (Non Locking) |          |
|--|----------|
| Pin 1  | Output + |
| Pin 2  | Output + |
| Pin 3  | Return   |
| Pin 4  | Return   |
| Outer Shell  | GND*     |
| Outer Shell C2 Models                                | Floating |

\* Functional earth.

Notes

1. Tolerance is 0.02 (0.5) maximum, except output cable length.
2. Weight 1.1 lbs (500 g).
3. Dimensions shown in inches (mm).

## Models and Ratings

| Output Power | Output Voltage | Output Current | Model Number <sup>(1)</sup> |
|--------------|----------------|----------------|-----------------------------|
| 150 W        | 12.0 VDC       | 12.50 A        | AHM150PS12                  |
| 150 W        | 15.0 VDC       | 10.00 A        | AHM150PS15                  |
| 150 W        | 19.0 VDC       | 7.89 A         | AHM150PS19                  |
| 150 W        | 24.0 VDC       | 6.25 A         | AHM150PS24                  |
| 150 W        | 48.0 VDC       | 3.13 A         | AHM150PS48                  |
| 150 W        | 12.0 VDC       | 12.50 A        | AHM150PS12C2                |
| 150 W        | 15.0 VDC       | 10.00 A        | AHM150PS15C2                |
| 150 W        | 19.0 VDC       | 7.89 A         | AHM150PS19C2                |
| 150 W        | 24.0 VDC       | 6.25 A         | AHM150PS24C2                |
| 150 W        | 48.0 VDC       | 3.13 A         | AHM150PS48C2                |

### Notes

- For optional input connector retention clip, add suffix '-A' to the model number e.g. AHM150PS24-A, not available for C8 connectors. Models with suffix 'C2' have a class II equipment protection classification. For IEC320-C8 input connector with class II models, add suffix '-8' to the model number, e.g. AHM150PS24C2-8.
- Alternate case colours available for OEM quantities, contact sales for information.

## Mechanical Details

Dimensions shown in inches (mm).

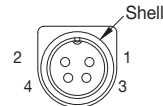
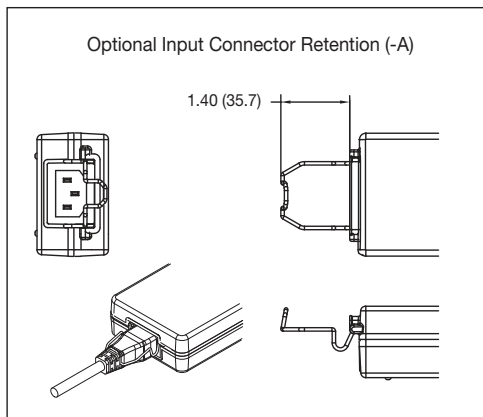
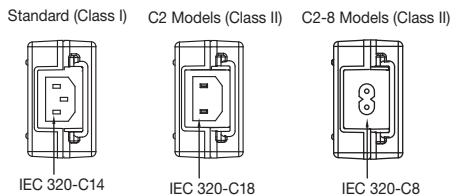
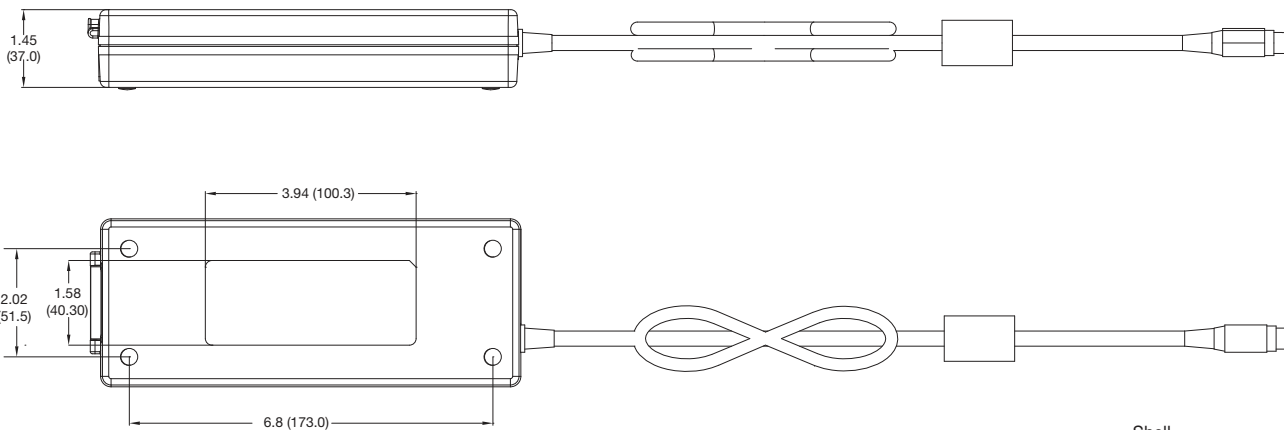
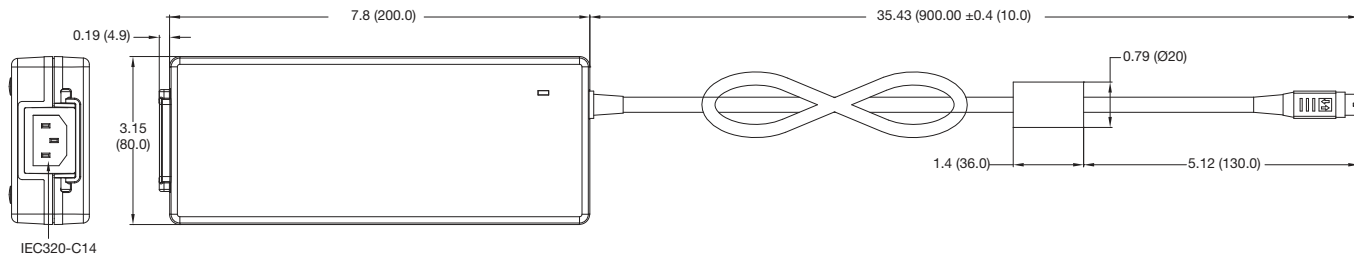

| Output Connector equivalent to KPPX-4P (Non Locking) |          |
|--|----------|
| Pin 1  | Output + |
| Pin 2  | Output + |
| Pin 3  | Return   |
| Pin 4  | Return   |
| Outer Shell  | GND*     |
| Outer Shell C2 Models                                | Floating |

\* Functional earth.

### Notes

- Tolerance is 0.02 (0.5) maximum, except output cable length.
- Weight 1.3 lbs (600 g).

Models and Ratings

| Output Power | Output Voltage | Output Current | Model Number |
|--------------|----------------|----------------|--------------|
| 165 W        | 12.0 VDC       | 13.75 A        | AHM180PS12   |
| 180 W        | 15.0 VDC       | 12.00 A        | AHM180PS15   |
| 180 W        | 19.0 VDC       | 9.47 A         | AHM180PS19   |
| 180 W        | 24.0 VDC       | 7.50 A         | AHM180PS24   |
| 180 W        | 48.0 VDC       | 3.75 A         | AHM180PS48   |
| 165 W        | 12.0 VDC       | 13.75 A        | AHM180PS12C2 |
| 180 W        | 15.0 VDC       | 12.00 A        | AHM180PS15C2 |
| 180 W        | 19.0 VDC       | 9.47 A         | AHM180PS19C2 |
| 180 W        | 24.0 VDC       | 7.50 A         | AHM180PS24C2 |
| 180 W        | 48.0 VDC       | 3.75 A         | AHM180PS48C2 |

Notes

- For optional input connector retention clip, add suffix '-A' to the model number e.g. AHM180PS24-A, not available for C8 connectors. Models with suffix 'C2' have a class II equipment protection classification. For IEC320-C8 input connector with class II models, add suffix '-8' to the model number, e.g. AHM180PS24C2-8.
- Alternate case colours available for OEM quantities, contact sales for information.

Mechanical Details

Dimensions shown in inches (mm).

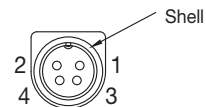
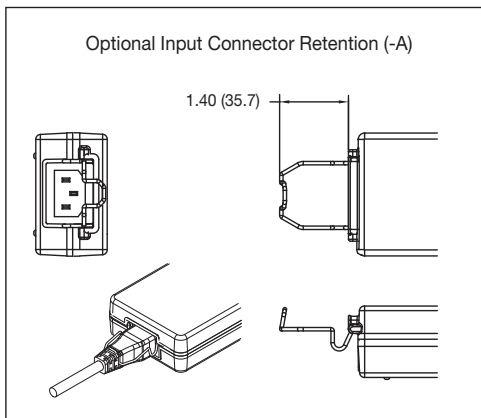
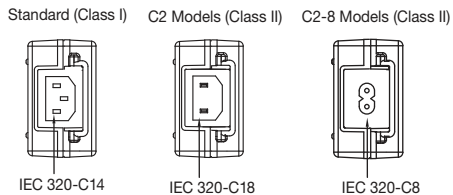
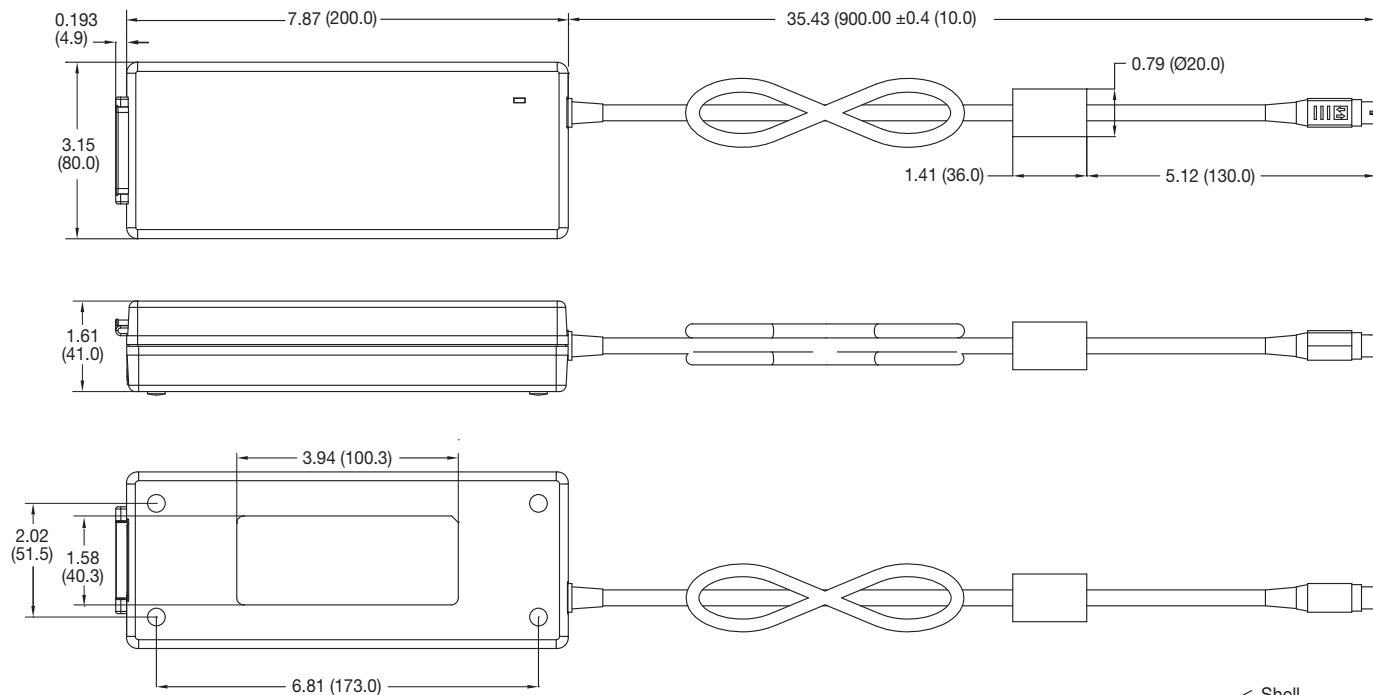

| Output Connector equivalent to KPPX-4P (Non Locking) |          |
|--|----------|
| Pin 1  | Output + |
| Pin 2  | Output + |
| Pin 3  | Return   |
| Pin 4  | Return   |
| Outer Shell  | GND*     |
| Outer Shell C2 Models                                | Floating |

\* Functional earth.

Notes

- Dimensions shown in inches (mm). Tolerance is 0.02 (0.5) maximum, except output cable length.
- Weight 1.4 lbs (620 g)

**Models and Ratings**

| Output Power | Output Voltage | Output Current | Model Number <sup>(2)</sup> |
|--------------|----------------|----------------|-----------------------------|
| 210 W        | 12.0 VDC       | 17.50 A        | AHM250PS12T                 |
| 220 W        | 15.0 VDC       | 14.66 A        | AHM250PS15T                 |
| 240 W        | 19.0 VDC       | 12.63 A        | AHM250PS19T                 |
| 250 W        | 24.0 VDC       | 10.41 A        | AHM250PS24T                 |
| 250 W        | 48.0 VDC       | 5.21 A         | AHM250PS48T                 |

**Notes**

1. For optional input connector retention clip, add suffix '-A' to the model number e.g. AHM250PS24T-A.
2. For 6 pin DIN connector, remove 'T' from the end of the model number e.g. AHM250PS24 (DIN connector for medical applications only).

**Mechanical Details**

Dimensions shown in inches (mm).

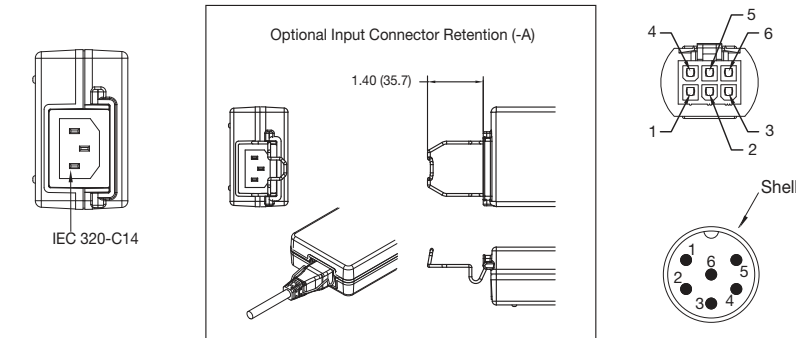
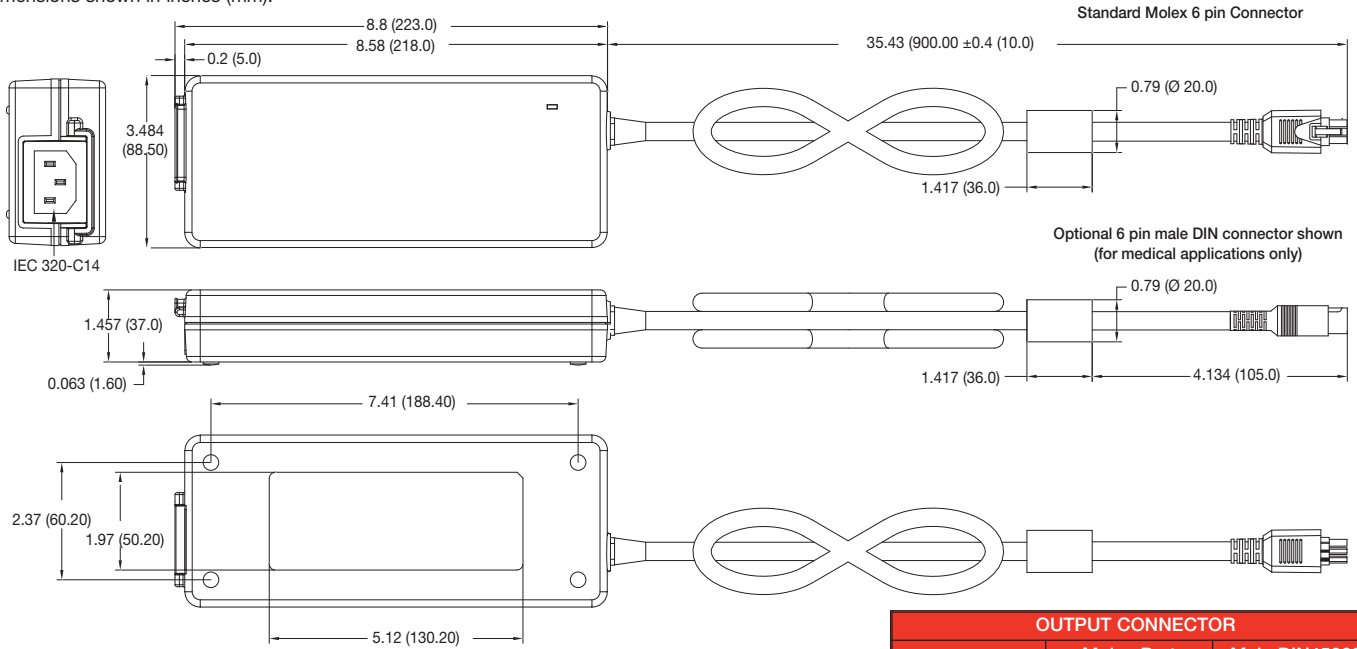

| OUTPUT CONNECTOR |                            |                      |
|------------------|----------------------------|----------------------|
| Pin No.          | Molex Part No.: 39-03-9062 | Male DIN45322 series |
| Pin 1            | Return                     | Output +             |
| Pin 2            | Return                     | Return               |
| Pin 3            | Return                     | Return               |
| Pin 4            | Output +                   | Return               |
| Pin 5            | Output +                   | Output +             |
| Pin 6            | Output +                   | Output +             |
| Outer Shell      |                            | GND*                 |

\* Functional earth.

**Notes**

1. Dimensions shown in inches (mm). Tolerance is 0.02 (0.5) maximum, except output cable length.
2. Weight 2.2 lbs (1000 g).

**Derating Curve**

