

# Miniature Push-Pull Circular Connectors

## HR25A Series

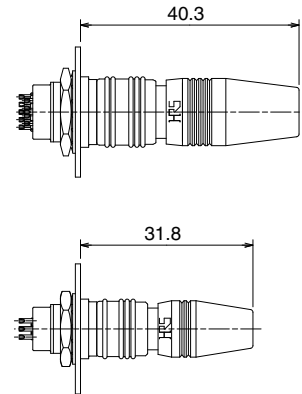

### Mated dimensions



### ■ Features

#### 1. Small size – high density

Outer diameters - plugs (max) : 11mm : 4, 6 and 8 positions  
13mm : 12, 16 and 20 positions

#### 2. Simple push-in/ pull-out mating / un-mating

Polarized for correct insertion by a straight push-in movement.  
Built-in lock release mechanism securely locks mated connectors while allowing quick disconnection by simply pulling on the plug release collar.

#### 3. Several mounting number of positions, styles and terminations

Number of positions : 4, 6, 8, 12, 16 and 20  
Connector : Plug, jack, receptacle  
Termination : Solder, crimp or PCB mounting type only for receptacle  
Choice of socket or pin contacts for plugs and receptacles.

#### 4. Metal shells

Secure lock between the metal shells provides excellent ground connection for the applications requiring EMI protection.

#### 5. RoHS compliant

All materials used in are compliant with RoHS regulations.

### ■ Diagrams of Connectors in Combination

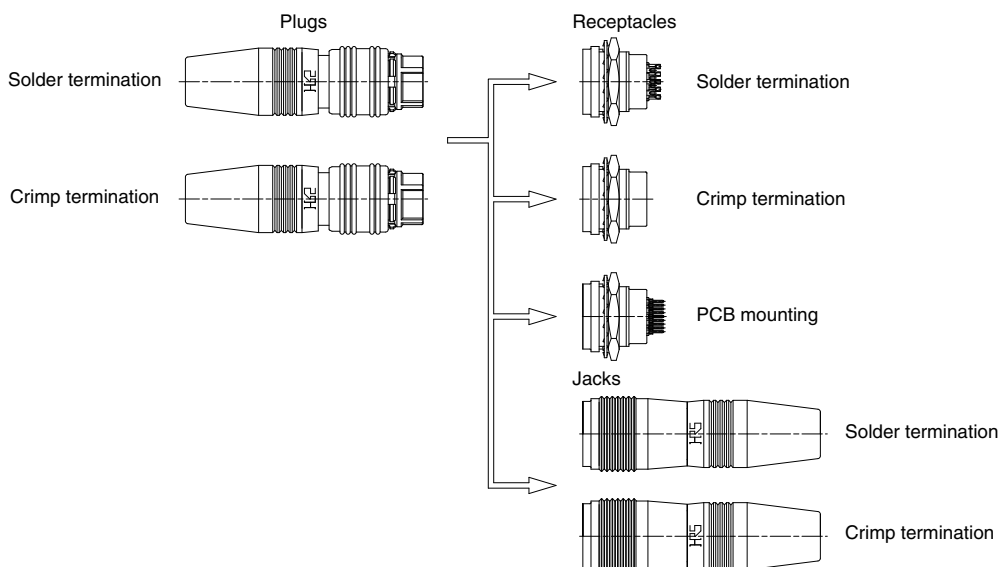

## ■ Specifications

Ratings	Current rating	1A	Operating temperature range	-25°C to +85°C
	Voltage rating	30V AC, 42V DC	Storage temperature range	-10°C to +60°C
Item	Specification		Conditions	
1. Insulation resistance	1,000MΩ min.		100V DC	
2. Withstanding voltage	No flashover or insulation breakdown		100V AC / 1 minute (test voltage)	
3. Contact resistance	30mΩ max.		1A DC	
4. Durability	Contact resistance : 50mΩ max.		No damage, cracks or parts dislocation 1,000 cycles	
5. Vibration	No electrical discontinuity of 10μs or longer No damage, cracks or parts dislocation.		Frequency : 10 to 55Hz, single amplitude of 0.75mm 5 minute cycle, 10 cycles in each of the 3 axis	
6. Humidity	Insulation resistance : 5MΩ min. (at high humidity) Insulation resistance : 50MΩ min. (when dry) No damage, cracks or parts dislocation.		96 hours at 40°C, and humidity of 90 to 95%	
7. Temperature cycle	Insulation resistance : 1,000MΩ min.		Temperature : -55°C → room temp. → +85°C → room temp. Time : 30min. → 2 to 3 min. → 30min. → 2 to 3 min. 5 cycles	

## ■ Materials / Finish

Item	Material	Finish	Remarks
Plug Jack	Outer shell	Zinc alloy	Nickel plated
	Insulator	PPS	UL94V-0
	Gasket, boots	Ethylene propylene rubber, Chloroprene rubber	
	Contacts	Phosphor bronze	Gold plated
Receptacle	Outer shell	Zinc alloy	Nickel plated
	Insulator	PPS	UL94V-0
	Contacts	Phosphor bronze	Gold plated

## ■ Product Number Structure

Refer to the chart below when determining the product specifications from the product number.  
Please select from the product numbers listed in this catalog when placing orders.

**HR25A - 7 P - 6 S C (\*\*)**

①
② ③
④ ⑤ ⑥
⑦

① Model name : HR25A Series	⑤ Contact type : S : Female contacts P : Male contacts
② Shell size : The shell size is the outer diameter of the mating end of the plug.	⑥ Termination type : Blank : Solder C : Crimp A : DIP
③ Connector type : P : Plug R : Receptacle J : Jack	⑦ Other specifications A two-digit character is added to indicate other specifications as needed.
④ Number of contacts : 4, 6, 8, 12, 16, 20	

■ Plug

● Solder termination (contacts inserted)

Shell size : 7

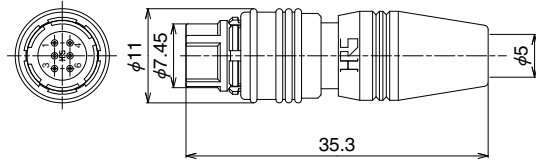

Shell size : 9

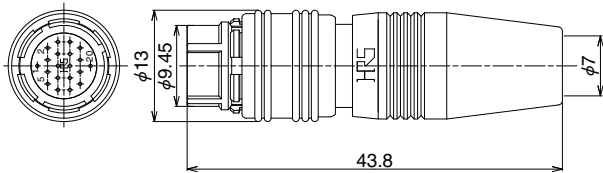

All dimensions : mm

Shell size	No. of contacts	Male contact type		Female contact type	
		Part No.	HRS No.	Part No.	HRS No.
7	4	HR25A-7P-4P	125-0612-1	HR25A-7P-4S	125-0613-4
	6	HR25A-7P-6P(31)	125-0602-8 31	HR25A-7P-6S	125-0611-9
	8	HR25A-7P-8P	125-0609-7	HR25A-7P-8S	125-0610-6
9	12	HR25A-9P-12P	125-0607-1	HR25A-9P-12S	125-0608-4
	16	HR25A-9P-16P	125-0605-6	HR25A-9P-16S	125-0606-9
	20	HR25A-9P-20P	125-0600-2	HR25A-9P-20S	125-0604-3

● Crimp termination (separate contacts required)

Shell size	No. of contacts	Male contact type		Female contact type	
		Part No.	HRS No.	Part No.	HRS No.
9	12	HR25A-9P-12PC	125-0652-6	HR25A-9P-12SC	125-0653-9
	16	HR25A-9P-16PC	125-0650-0	HR25A-9P-16SC	125-0651-3
	20	HR25A-9P-20PC	125-0648-9	HR25A-9P-20SC	125-0649-1

## ■ Receptacle

### ● Solder termination (contacts inserted)

Shell size : 7

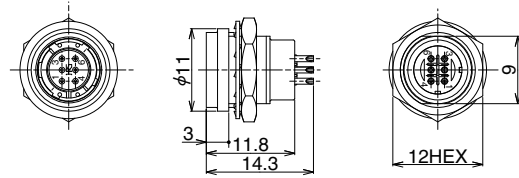

Shell size : 9

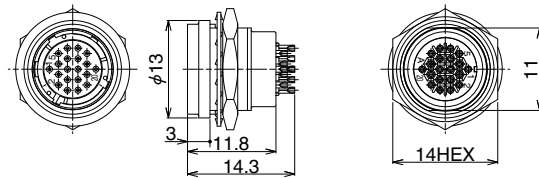

All dimensions : mm

Shell size	No. of contacts	Male contact type		Female contact type	
		Part No.	HRS No.	Part No.	HRS No.
7	4	HR25A-7R-4P	125-0623-8	HR25A-7R-4S	125-0622-5
	6	HR25A-7R-6P	125-0621-2	HR25A-7R-6S	125-0603-0
	8	HR25A-7R-8P	125-0620-0	HR25A-7R-8S	125-0619-0
9	12	HR25A-9R-12P	125-0618-8	HR25A-9R-12S	125-0617-5
	16	HR25A-9R-16P	125-0616-2	HR25A-9R-16S	125-0615-0
	20	HR25A-9R-20P	125-0614-7	HR25A-9R-20S	125-0601-5

### ● Crimp termination (separate contacts required)

Male contact type  
HR25A-9R-20PC

Female contact type  
HR25A-9R-20SC

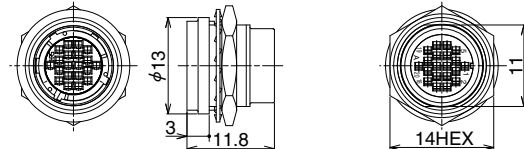
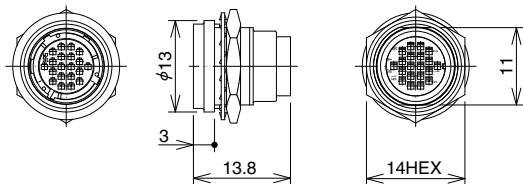

All dimensions : mm

Shell size	No. of contacts	Male contact type		Female contact type	
		Part No.	HRS No.	Part No.	HRS No.
9	12	HR25A-9R-12PC	125-0659-5	HR25A-9R-12SC	125-0658-2
	16	HR25A-9R-16PC	125-0657-0	HR25A-9R-16SC	125-0656-7
	20	HR25A-9R-20PC	125-0654-1	HR25A-9R-20SC	125-0655-4

## ■ Receptacle

### ● Through hole (for PC board mounting)

Shell size : 7  
HR25A-7R-6SA

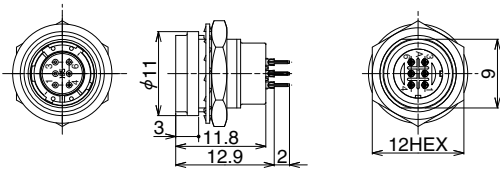

Shell size : 9  
HR25A-9R-20SA

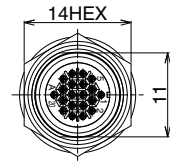
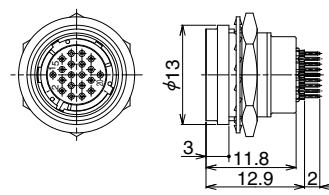

All dimensions : mm

Shell size	No. of contacts	Male contact type		Female contact type	
		Part No.	HRS No.	Part No.	HRS No.
7	4	HR25A-7R-4PA	125-0647-6	HR25A-7R-4SA	125-0646-3
	6	HR25A-7R-6PA	125-0645-0	HR25A-7R-6SA	125-0644-8
	8	HR25A-7R-8PA	125-0643-5	HR25A-7R-8SA	125-0642-2
9	12	HR25A-9R-12PA	125-0641-0	HR25A-9R-12SA	125-0640-7
	16	HR25A-9R-16PA	125-0639-8	HR25A-9R-16SA	125-0638-5
	20	HR25A-9R-20PA	125-0637-2	HR25A-9R-20SA	125-0636-0

## ■ Jack

### ● Solder termination (contact inserted)

Shell size : 7  
HR25A-7J-6S

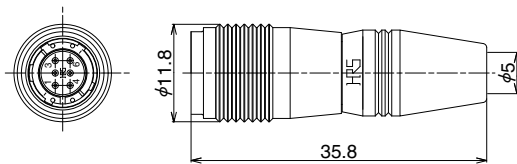

Shell size : 9  
HR25A-9J-20S

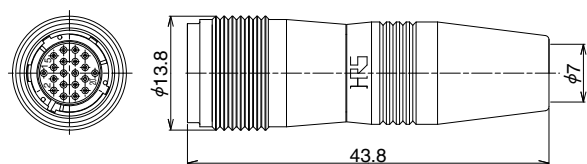

All dimensions : mm

Shell size	No. of contacts	Male contact type		Female contact type	
		Part No.	HRS No.	Part No.	HRS No.
7	4	HR25A-7J-4P	125-0635-7	HR25A-7J-4S	125-0634-4
	6	HR25A-7J-6P	125-0633-1	HR25A-7J-6S	125-0632-9
	8	HR25A-7J-8P	125-0631-6	HR25A-7J-8S	125-0630-3
9	12	HR25A-9J-12P	125-0629-4	HR25A-9J-12S	125-0628-1
	16	HR25A-9J-16P	125-0627-9	HR25A-9J-16S	125-0626-6
	20	HR25A-9J-20P	125-0625-3	HR25A-9J-20S	125-0624-0

### ● Crimp termination (separate contacts required)

Shell size	No. of contacts	Male contact type		Female contact type	
		Part No.	HRS No.	Part No.	HRS No.
9	12	HR25A-9J-12PC	125-0665-8	HR25A-9J-12SC	125-0664-5
	16	HR25A-9J-16PC	125-0663-2	HR25A-9J-16SC	125-0662-0
	20	HR25A-9J-20PC	125-0661-7	HR25A-9J-20SC	125-0660-4

◆ Crimp contact

Male contact

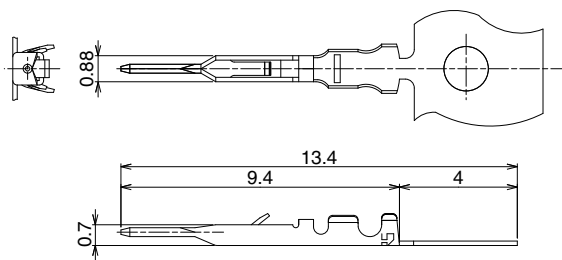

Female contact

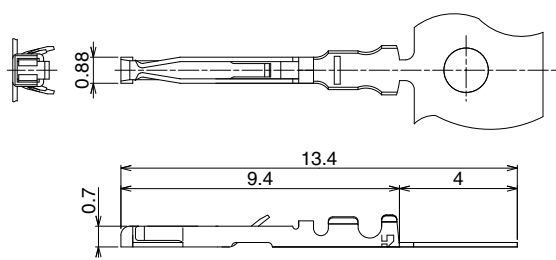

All dimensions : mm

Type	Part No.	HRS No.	Conductor size / construction	Type	Part No.	HRS No.	Conductor size / construction
Loose contact	HR25-PC-111	125-0419-1	30 AWG	Loose contact	HR25-SC-111	125-0421-3	30 AWG
Reel contact	HR25-PC-211	125-0420-0		Reel contact	HR25-SC-211	125-0422-6	

Note 1 : Wire jacket outer diameter 0.71mm max.

Note 2 : Loose piece contacts are packaged 100 pcs/pack. Reel contacts are packaged 10,000 pcs/reel.

◆ Applicable tools

Type	Part No.	HRS No.	Used on
Manual contact crimping tool	HR25-TA3032HC	150-0207-3	HR25-PC-111 or HR25-SC-111
Automatic crimping machine	CM-105C	901-0001-0	—
Applicator	AP105-HR25-1	901-2040-6	HR25-PC-211 or HR25-SC-211
Cable clamp crimp tool	HR10A-TC-02	150-0041-2	—
Solder termination fixture	HR25A-7P-T02	150-0243-7	HR25A-7P For tightening
	HR25-7P-T01	150-0085-8	HR25A-7P For wiring
Plug shell tightening fixture	HR25A-9P-T02	150-0242-4	HR25A-9P For tightening
	HR25-9P-T01	150-0086-0	HR25A-9P For wiring
Contact extraction tool	HR25-TP	150-0091-0	—

◆ Panel cutouts

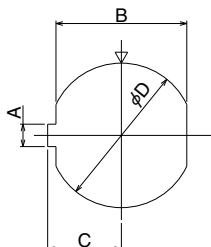

All dimensions : mm

Dimensions	HR25A-7R	HR25A-9R
A	1.55 <sup>+0.05</sup> <sub>0</sub>	
B	9.05 <sup>+0.03</sup> <sub>-0.02</sub>	11.05 <sup>+0.03</sup> <sub>-0.02</sub>
C	5.1 <sup>+0.1</sup> <sub>0</sub>	6.1 <sup>+0.1</sup> <sub>0</sub>
D	10 <sup>+0.05</sup> <sub>0</sub>	12 <sup>+0.05</sup> <sub>0</sub>
Applicable panel thickness	0.7 to 2	

Note 1 : The receptacle panel cutout is a view from the mating side.

◆ PCB mounting pattern (for through-hole PC board mounting)

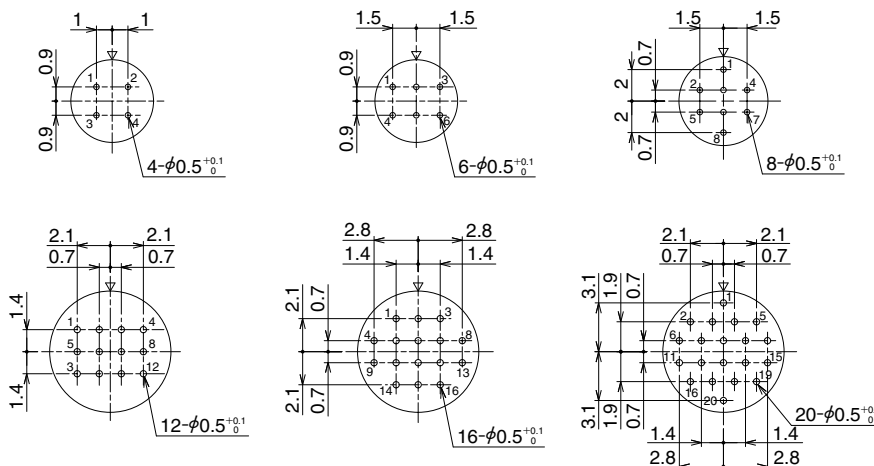

Note 1 : The above diagrams are viewed from the engagement side of the socket insert (i.e., the wiring side of the pin insert).

Note 2 : The ▽ mark of the above diagrams indicates the engagement guide key position.

Note 3 : Plated through hole location and diameter tolerance: ±0.05.

## ◆ Contact Position Arrangement

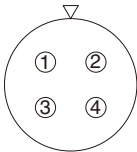
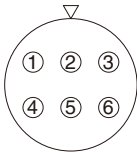
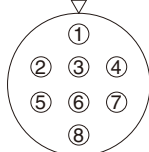
Shell size	Size 7		
Contact configuration			
No. of contacts	4	6	8
Withstand voltage	100V AC for 1 minute		
Current capacity	1A		
Insulation resistance	1,000MΩ or greater		
Contact resistance	30mΩ		
Solderpot inner diameter	0.5mm dia.		

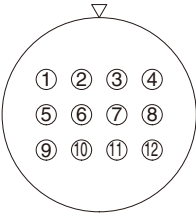
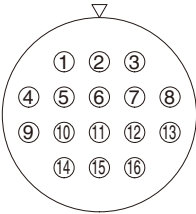
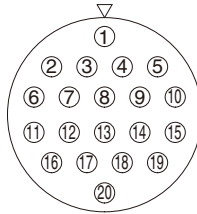
Shell size	Size 9		
Contact configuration			
No. of contacts	12	16	20
Withstand voltage	100V AC for 1 minute		
Current capacity	1A		
Insulation resistance	1,000MΩ or greater		
Contact resistance	30mΩ		
Solderpot inner diameter	0.5mm dia.		

Note 1 : The above diagrams are viewed from the engagement side of the socket insert (i.e., the wiring side of the pin insert).

Note 2 : The ▽ mark of the above diagrams indicates the engagement guide key position.

Note 3 : The withstand voltage indicates the test voltage value. For regular use the voltage used should be less than 30V AC or 42V DC.

Note 4 : The current capacity of the crimp terminals indicates the value when using wire of 30 AWG.

Note 5 : The insulation resistance indicates a value when measured at 100V DC.

## ◆ Precautions

1. Switch off the power of the circuit before disconnecting or plugging-in the connectors.
2. Use connectors with socket contacts at the power side of the circuit.
3. Make sure that the coupling is in completely cocked position.
4. Cable clamping, cable rotation, and other forces may vary with the cable construction.  
Please make sure that your cable is suitable for use with these connectors before usage and production.
5. For plug and jack, screw part of shell has an anti-looseness coating (Mec process), but the adhesive function is impaired when they are reused. Therefore, apply Loctite 263 which is manufactured by Henkel Japan Ltd., Tokyo to the screw part during reassembly in order to prevent looseness.

# MEMO:

Lined area for memo with horizontal dashed lines.

---

## HIROSE ELECTRIC CO.,LTD.

2-6-3,Nakagawa Chuoh,Tsuzuki-Ku,Yokohama-Shi 224-8540,JAPAN  
<https://www.hirose.com/>

---