

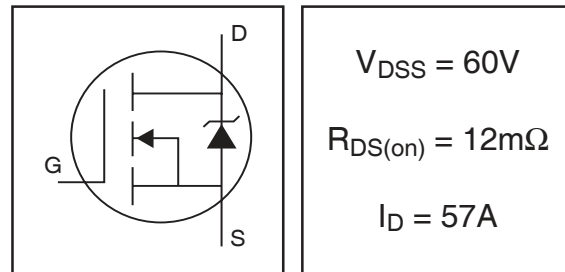
**Features**

- Advanced Process Technology
- Ultra Low On-Resistance
- 175°C Operating Temperature
- Fast Switching
- Repetitive Avalanche Allowed up to Tjmax
- Lead-Free

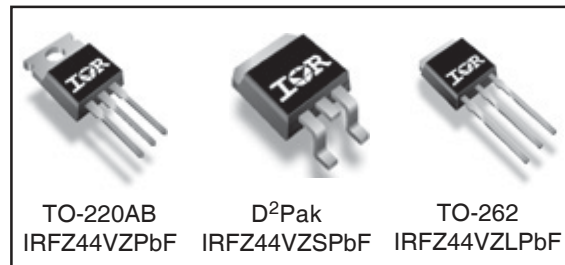
**Description**

This HEXFET® Power MOSFET utilizes the latest processing techniques to achieve extremely low on-resistance per silicon area. Additional features of this design are a 175°C junction operating temperature, fast switching speed and improved repetitive avalanche rating. These features combine to make this design an extremely efficient and reliable device for use in a wide variety of applications.

HEXFET® Power MOSFET



$V_{DSS} = 60V$   
 $R_{DS(on)} = 12m\Omega$   
 $I_D = 57A$



**Absolute Maximum Ratings**

	Parameter	Max.	Units
$I_D @ T_C = 25^\circ C$	Continuous Drain Current, $V_{GS} @ 10V$ (Silicon Limited)	57	A
$I_D @ T_C = 100^\circ C$	Continuous Drain Current, $V_{GS} @ 10V$	40	
$I_{DM}$	Pulsed Drain Current ①	230	
$P_D @ T_C = 25^\circ C$	Power Dissipation	92	W
	Linear Derating Factor	0.61	W/°C
$V_{GS}$	Gate-to-Source Voltage	$\pm 20$	V
$E_{AS}$ (Thermally limited)	Single Pulse Avalanche Energy ②	73	mJ
$E_{AS}$ (Tested )	Single Pulse Avalanche Energy Tested Value ③	110	
$I_{AR}$	Avalanche Current ④	See Fig.12a, 12b, 15, 16	A
$E_{AR}$	Repetitive Avalanche Energy ⑤		mJ
$T_J$	Operating Junction and	-55 to + 175	°C
$T_{STG}$	Storage Temperature Range		
	Soldering Temperature, for 10 seconds	300 (1.6mm from case )	
	Mounting Torque, 6-32 or M3 screw ⑦	10 lbf•in (1.1N•m)	

**Thermal Resistance**

	Parameter	Typ.	Max.	Units
$R_{\theta JC}$	Junction-to-Case	—	1.64	°C/W
$R_{\theta CS}$	Case-to-Sink, Flat Greased Surface ⑧	0.50	—	
$R_{\theta JA}$	Junction-to-Ambient ⑨	—	62	
$R_{\theta JA}$	Junction-to-Ambient (PCB Mount) ⑩	—	40	

# IRFZ44VZS/LPbF

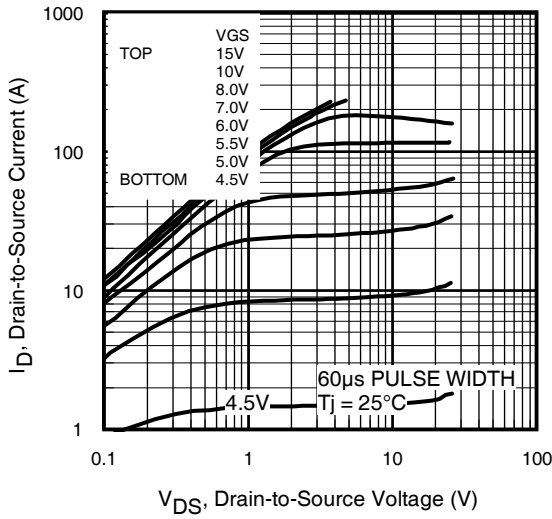
International  
**IR** Rectifier

## Electrical Characteristics @ T<sub>J</sub> = 25°C (unless otherwise specified)

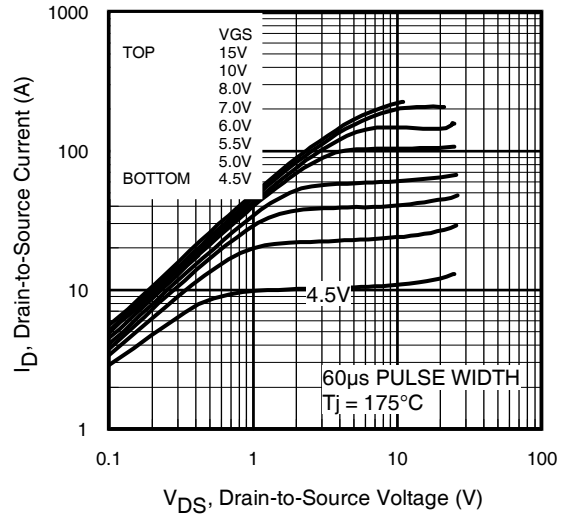
	Parameter	Min.	Typ.	Max.	Units	Conditions
V <sub>(BR)DSS</sub>	Drain-to-Source Breakdown Voltage	60	—	—	V	V <sub>GS</sub> = 0V, I <sub>D</sub> = 250μA
ΔV <sub>(BR)DSS</sub> /ΔT <sub>J</sub>	Breakdown Voltage Temp. Coefficient	—	0.061	—	V/°C	Reference to 25°C, I <sub>D</sub> = 1mA
R <sub>DS(on)</sub>	Static Drain-to-Source On-Resistance	—	9.6	12	mΩ	V <sub>GS</sub> = 10V, I <sub>D</sub> = 34A ③
V <sub>GS(th)</sub>	Gate Threshold Voltage	2.0	—	4.0	V	V <sub>DS</sub> = V <sub>GS</sub> , I <sub>D</sub> = 250μA
g <sub>fs</sub>	Forward Transconductance	25	—	—	V	V <sub>DS</sub> = 25V, I <sub>D</sub> = 34A
I <sub>DSS</sub>	Drain-to-Source Leakage Current	—	—	20	μA	V <sub>DS</sub> = 60V, V <sub>GS</sub> = 0V
		—	—	250		V <sub>DS</sub> = 60V, V <sub>GS</sub> = 0V, T <sub>J</sub> = 125°C
I <sub>GSS</sub>	Gate-to-Source Forward Leakage	—	—	200	nA	V <sub>GS</sub> = 20V
	Gate-to-Source Reverse Leakage	—	—	-200		V <sub>GS</sub> = -20V
Q <sub>g</sub>	Total Gate Charge	—	43	65		I <sub>D</sub> = 34A
Q <sub>gs</sub>	Gate-to-Source Charge	—	11	—	nC	V <sub>DS</sub> = 48V
Q <sub>gd</sub>	Gate-to-Drain ("Miller") Charge	—	18	—		V <sub>GS</sub> = 10V ③
t <sub>d(on)</sub>	Turn-On Delay Time	—	14	—	ns	V <sub>DD</sub> = 30V
t <sub>r</sub>	Rise Time	—	62	—		I <sub>D</sub> = 34A
t <sub>d(off)</sub>	Turn-Off Delay Time	—	35	—		R <sub>G</sub> = 12 Ω
t <sub>f</sub>	Fall Time	—	38	—		V <sub>GS</sub> = 10V ③
L <sub>D</sub>	Internal Drain Inductance	—	4.5	—	nH	Between lead, 6mm (0.25in.) from package and center of die contact
L <sub>S</sub>	Internal Source Inductance	—	7.5	—		
C <sub>iss</sub>	Input Capacitance	—	1690	—	pF	V <sub>GS</sub> = 0V
C <sub>oss</sub>	Output Capacitance	—	270	—		V <sub>DS</sub> = 25V
C <sub>rss</sub>	Reverse Transfer Capacitance	—	130	—		f = 1.0MHz
C <sub>oss</sub>	Output Capacitance	—	1870	—		V <sub>GS</sub> = 0V, V <sub>DS</sub> = 1.0V, f = 1.0MHz
C <sub>oss</sub>	Output Capacitance	—	260	—		V <sub>GS</sub> = 0V, V <sub>DS</sub> = 48V, f = 1.0MHz
C <sub>oss eff.</sub>	Effective Output Capacitance	—	510	—		V <sub>GS</sub> = 0V, V <sub>DS</sub> = 0V to 48V ④

## Source-Drain Ratings and Characteristics

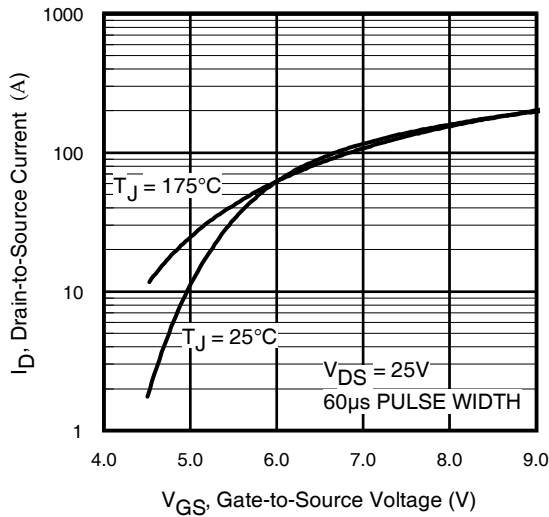
	Parameter	Min.	Typ.	Max.	Units	Conditions
I <sub>S</sub>	Continuous Source Current (Body Diode)	—	—	57	A	MOSFET symbol showing the integral reverse p-n junction diode.
I <sub>SM</sub>	Pulsed Source Current (Body Diode) ①	—	—	230		
V <sub>SD</sub>	Diode Forward Voltage	—	—	1.3	V	T <sub>J</sub> = 25°C, I <sub>S</sub> = 34A, V <sub>GS</sub> = 0V ③
t <sub>rr</sub>	Reverse Recovery Time	—	23	35	ns	T <sub>J</sub> = 25°C, I <sub>F</sub> = 34A, V <sub>DD</sub> = 30V
Q <sub>rr</sub>	Reverse Recovery Charge	—	17	26	nC	di/dt = 100A/μs ③
t <sub>on</sub>	Forward Turn-On Time	Intrinsic turn-on time is negligible (turn-on is dominated by LS+LD)				



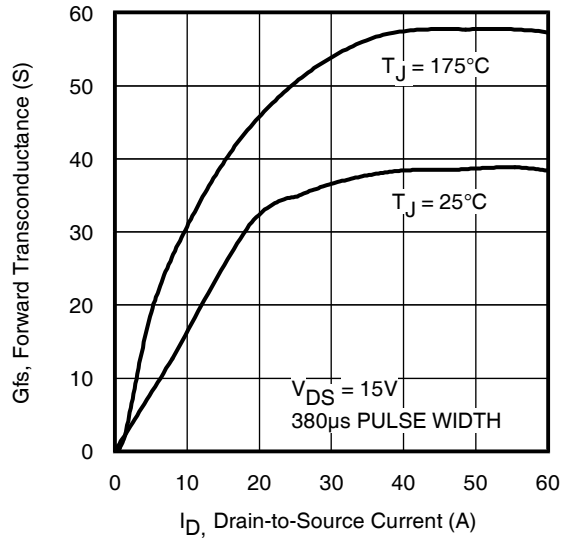
**Fig 1.** Typical Output Characteristics



**Fig 2.** Typical Output Characteristics

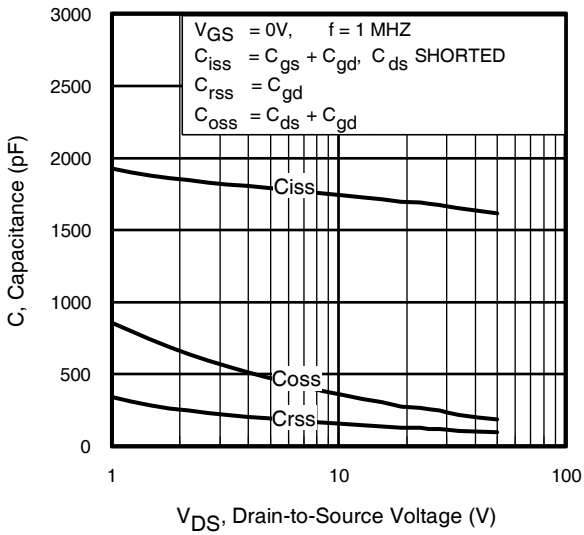


**Fig 3.** Typical Transfer Characteristics

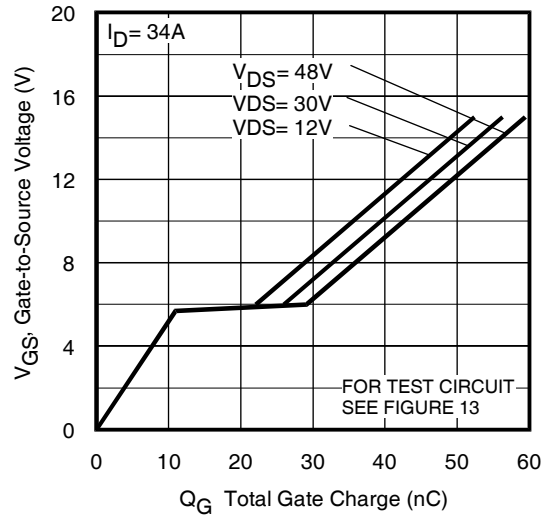


**Fig 4.** Typical Forward Transconductance Vs. Drain Current

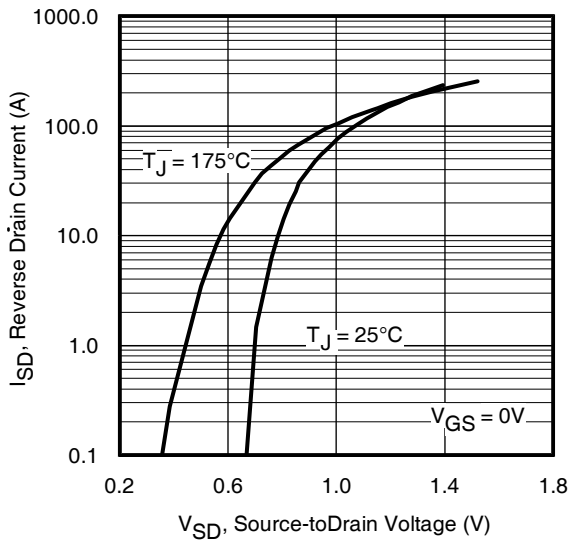
# IRFZ44VZS/LPbF



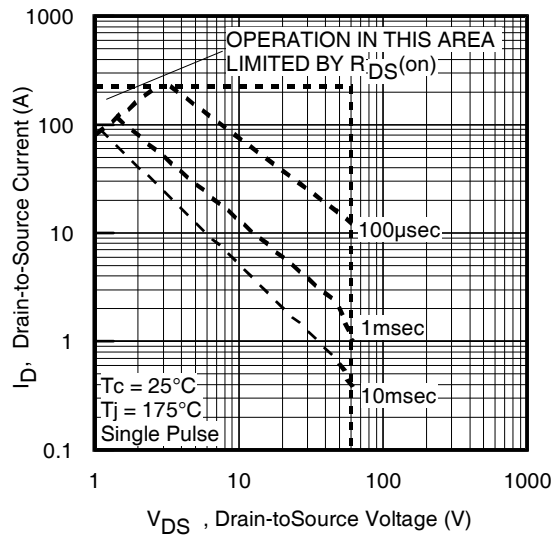
**Fig 5.** Typical Capacitance Vs. Drain-to-Source Voltage



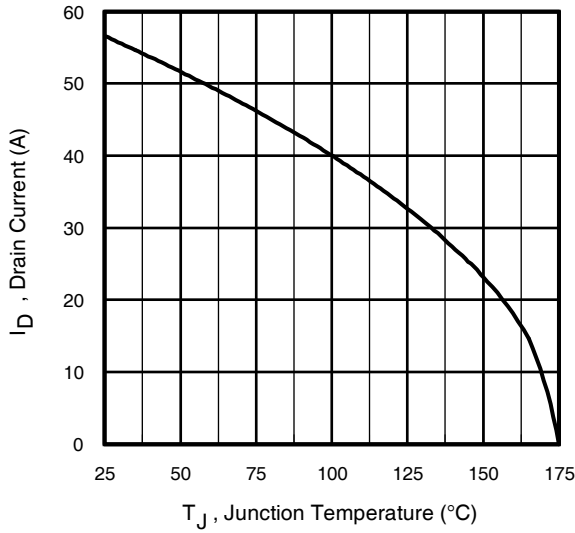
**Fig 6.** Typical Gate Charge Vs. Gate-to-Source Voltage



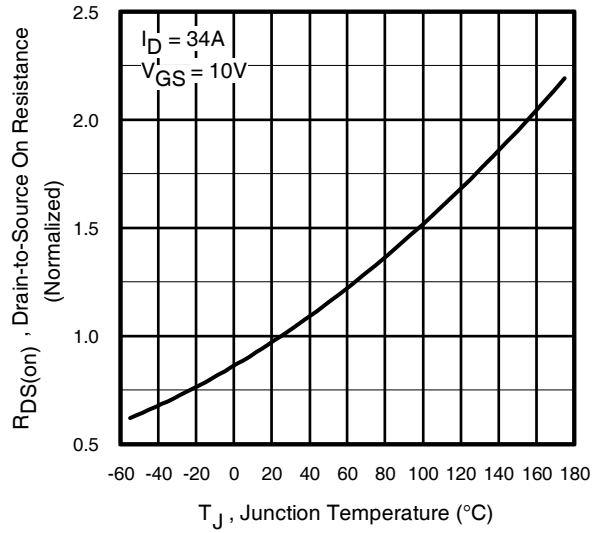
**Fig 7.** Typical Source-Drain Diode Forward Voltage



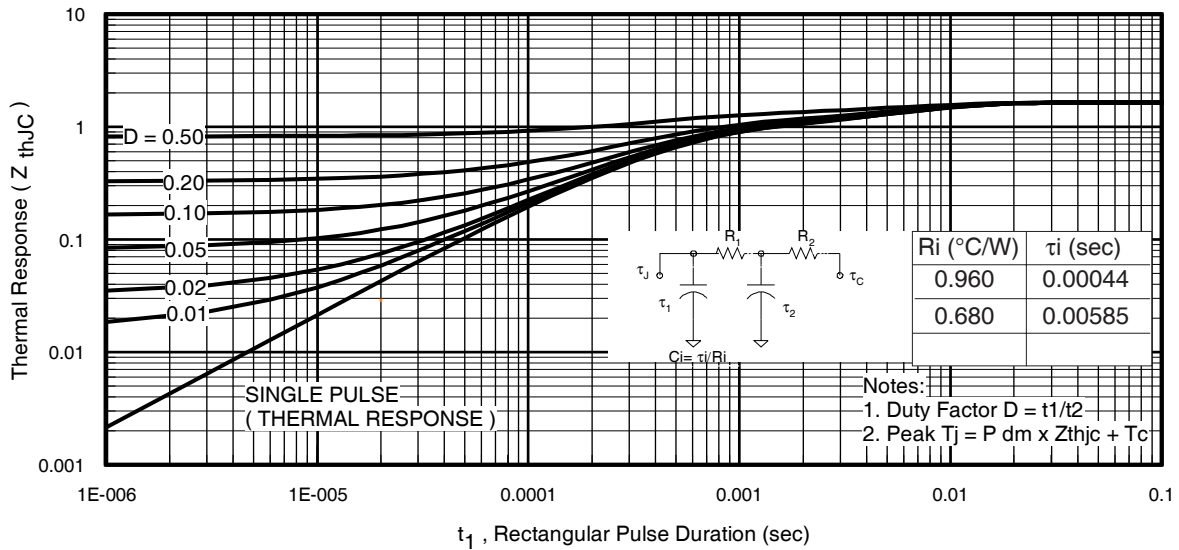
**Fig 8.** Maximum Safe Operating Area



**Fig 9.** Maximum Drain Current Vs. Case Temperature

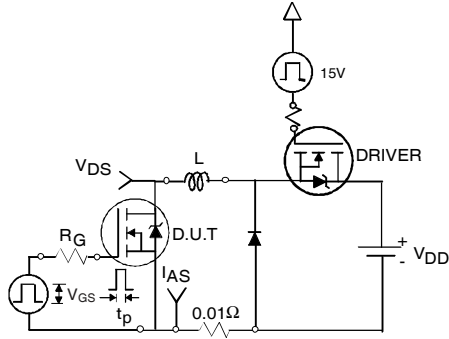


**Fig 10.** Normalized On-Resistance Vs. Temperature

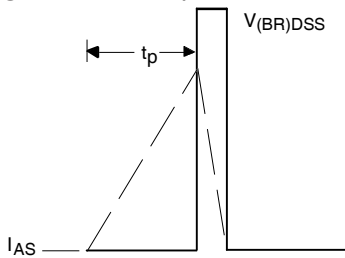


**Fig 11.** Maximum Effective Transient Thermal Impedance, Junction-to-Case

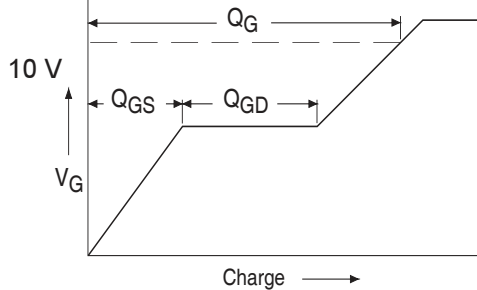
# IRFZ44VZS/LPbF



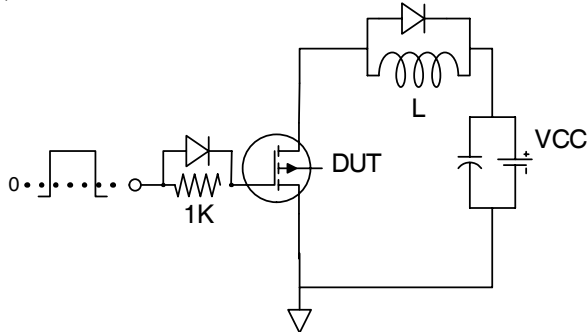
**Fig 12a.** Unclamped Inductive Test Circuit



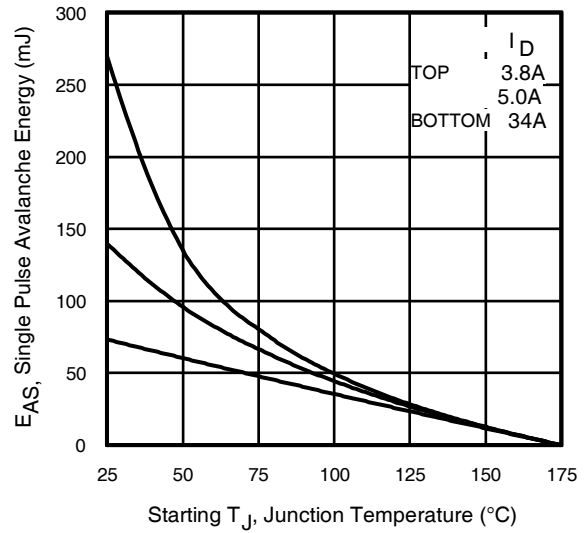
**Fig 12b.** Unclamped Inductive Waveforms



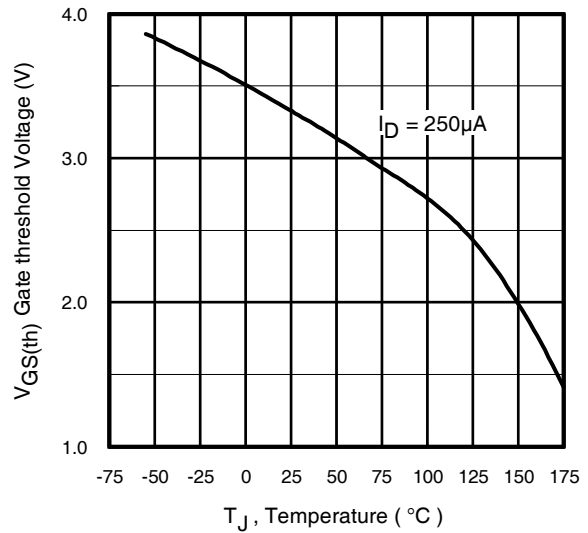
**Fig 13a.** Basic Gate Charge Waveform



**Fig 13b.** Gate Charge Test Circuit



**Fig 12c.** Maximum Avalanche Energy Vs. Drain Current



**Fig 14.** Threshold Voltage Vs. Temperature

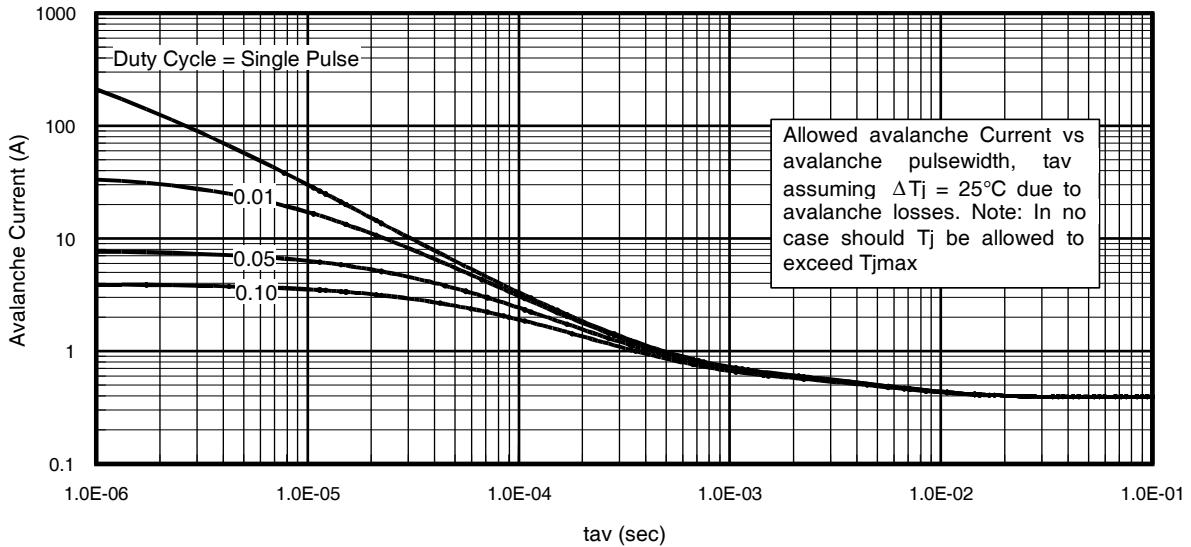


Fig 15. Typical Avalanche Current Vs.Pulsewidth

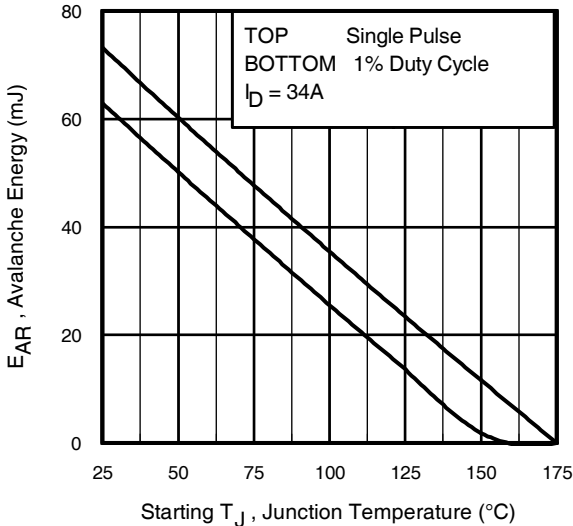


Fig 16. Maximum Avalanche Energy Vs. Temperature

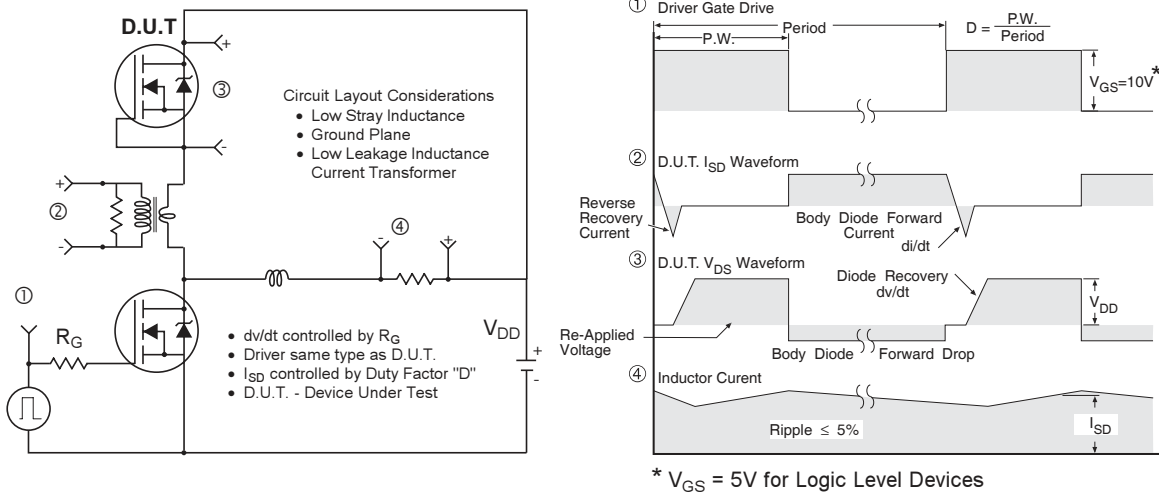
**Notes on Repetitive Avalanche Curves , Figures 15, 16:**  
(For further info, see AN-1005 at [www.irf.com](http://www.irf.com))

1. Avalanche failures assumption:  
Purely a thermal phenomenon and failure occurs at a temperature far in excess of  $T_{jmax}$ . This is validated for every part type.
2. Safe operation in Avalanche is allowed as long as  $T_{jmax}$  is not exceeded.
3. Equation below based on circuit and waveforms shown in Figures 12a, 12b.
4.  $P_{D(ave)}$  = Average power dissipation per single avalanche pulse.
5. BV = Rated breakdown voltage (1.3 factor accounts for voltage increase during avalanche).
6.  $I_{av}$  = Allowable avalanche current.
7.  $\Delta T$  = Allowable rise in junction temperature, not to exceed  $T_{jmax}$  (assumed as 25°C in Figure 15, 16).  
 $t_{av}$  = Average time in avalanche.  
 $D$  = Duty cycle in avalanche =  $t_{av} \cdot f$   
 $Z_{thJC}(D, t_{av})$  = Transient thermal resistance, see figure 11)

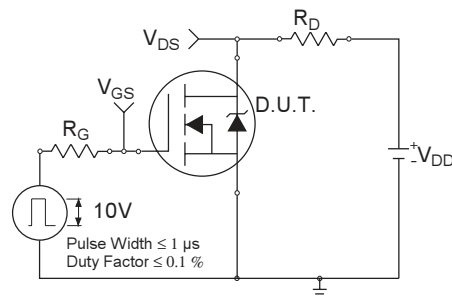
$$P_{D(ave)} = 1/2 ( 1.3 \cdot BV \cdot I_{av} ) = \Delta T / Z_{thJC}$$

$$I_{av} = 2\Delta T / [ 1.3 \cdot BV \cdot Z_{th} ]$$

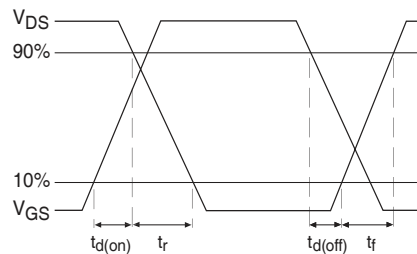
$$E_{AS(AR)} = P_{D(ave)} \cdot t_{av}$$



**Fig 17. Peak Diode Recovery dv/dt Test Circuit for N-Channel HEXFET® Power MOSFETs**



**Fig 18a. Switching Time Test Circuit**

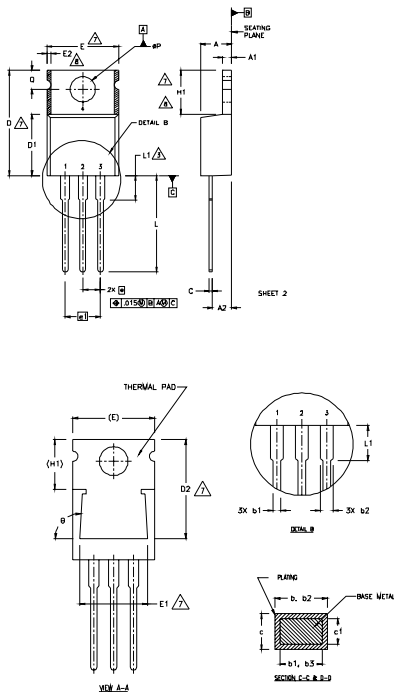


**Fig 18b. Switching Time Waveforms**



## TO-220AB Package Outline

Dimensions are shown in millimeters (inches)



**NOTES:**

- 1 DIMENSIONING AND TOLERANCING PER ASME Y14.5 M- 1994.
- 2 DIMENSIONS ARE SHOWN IN INCHES [MILLIMETERS].
- 3 LEAD DIMENSION AND FINISH UNCONTROLLED IN L1.
- 4 DIMENSION D & E DO NOT INCLUDE MOLD FLASH. MOLD FLASH SHALL NOT EXCEED .005" (0.127) PER SIDE. THESE DIMENSIONS ARE MEASURED AT THE OUTERMOST EXTREMES OF THE PLASTIC BODY.
- 5 DIMENSION b1 & c1 APPLY TO BASE METAL ONLY.
- 6 CONTROLLING DIMENSION - INCHES.
- 7 THERMAL PAD CONTOUR OPTIONAL WITHIN DIMENSIONS E, H1, D2 & E1
- 8 DIMENSION E2 X H1 DEFINE A ZONE WHERE STAMPING AND SINGULATION IRREGULARITIES ARE ALLOWED.

**LEAD ASSIGNMENTS**

- HEMSET**
- 1 - GATE
  - 2 - DRAIN
  - 3 - SOURCE

**IGBTs - CoPACK**

- 1 - GATE
- 2 - COLLECTOR
- 3 - EMITTER

**DIODES**

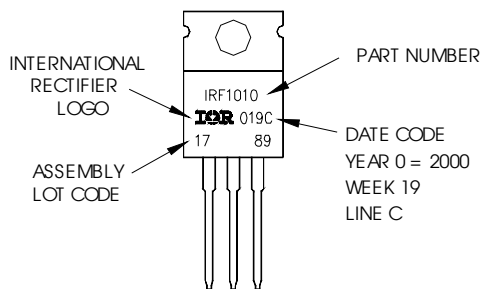
- 1 - ANODE/OPEN
- 2 - CATHODE
- 3 - ANODE

SYMBOL	DIMENSIONS				NOTES
	MILLIMETERS		INCHES		
	MIN.	MAX.	MIN.	MAX.	
A	3.56	4.82	.140	.190	
A1	0.51	1.40	.020	.055	
A2	2.04	2.92	.080	.115	
b	0.38	1.01	.015	.040	
b1	0.38	0.96	.015	.038	5
b2	1.15	1.77	.045	.070	
b3	1.15	1.73	.045	.068	
c	0.36	0.61	.014	.024	
c1	0.36	0.56	.014	.022	5
D	14.22	16.51	.560	.650	4
D1	8.38	9.02	.330	.355	
D2	12.19	12.88	.480	.507	7
E	9.66	10.66	.380	.420	4,7
E1	8.38	8.89	.330	.350	7
e	2.54 BSC		.100 BSC		
e1	5.08		.200 BSC		
H1	5.85	6.55	.230	.270	7,8
L	12.70	14.73	.500	.580	
L1	-	6.35	-	.250	3
ØP	3.54	4.08	.139	.161	
Q	2.54	3.42	.100	.135	
Ø	90°-93°		90°-93°		

## TO-220AB Part Marking Information

EXAMPLE: THIS IS AN IRF1010  
LOT CODE 1789  
ASSEMBLED ON WW 19, 2000  
IN THE ASSEMBLY LINE "C"

Note: "P" in assembly line position  
indicates "Lead-Free"



**Notes:**

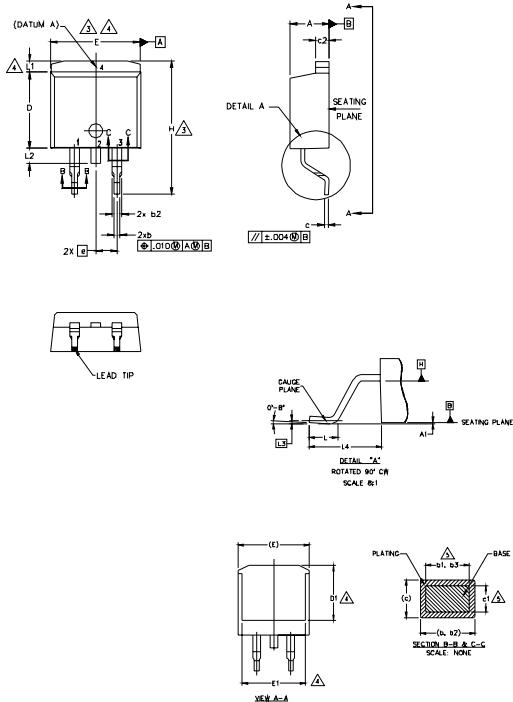
1. For an Automotive Qualified version of this part please see <http://www.irf.com/product-info/auto/>
2. For the most current drawing please refer to IR website at <http://www.irf.com/package/>

# IRFZ44VZS/LPbF

International  
**IR** Rectifier

## D<sup>2</sup>Pak (TO-263AB) Package Outline

Dimensions are shown in millimeters (inches)



- NOTES:
1. DIMENSIONING AND TOLERANCING PER ASME Y14.5M-1994
  2. DIMENSIONS ARE SHOWN IN MILLIMETERS (INCHES).
  3. DIMENSION D & E DO NOT INCLUDE MOLD FLASH. MOLD FLASH SHALL NOT EXCEED 0.127 (.005") PER SIDE. THESE DIMENSIONS ARE MEASURED AT THE OUTMOST EXTREMES OF THE PLASTIC BODY AT DATUM H.
  4. THERMAL PAD CONTOUR OPTIONAL WITHIN DIMENSION E, L1, D1 & E1.
  5. DIMENSION b1 AND c1 APPLY TO BASE METAL ONLY.
  6. DATUM A & B TO BE DETERMINED AT DATUM PLANE H.
  7. CONTROLLING DIMENSION: INCH.
  8. OUTLINE CONFORMS TO JEDEC OUTLINE TO-263AB.

SYMBOL	DIMENSIONS				NOTES
	MILLIMETERS		INCHES		
	MIN.	MAX.	MIN.	MAX.	
A	4.06	4.83	.160	.190	5
A1	0.00	0.254	.000	.010	
b	0.51	0.99	.020	.039	
b1	0.51	0.89	.020	.035	5
b2	1.14	1.78	.045	.070	
b3	1.14	1.73	.045	.068	5
c	0.38	0.74	.015	.029	
c1	0.38	0.58	.015	.023	5
c2	1.14	1.65	.045	.065	
D	8.38	9.65	.330	.380	3
D1	6.86	-	.270	-	
E	9.65	10.67	.380	.420	3,4
E1	6.22	-	.245	-	
e	2.54 BSC		.100 BSC		4
H	14.61	15.88	.575	.625	
L	1.78	2.79	.070	.110	4
L1	-	1.65	-	.066	
L2	1.27	1.78	-	.070	
L3	0.25 BSC		.010 BSC		
L4	4.78	5.28	.188	.208	

### LEAD ASSIGNMENTS

#### HEXFET

- 1.- GATE
2. 4.- DRAIN
- 3.- SOURCE

#### IGBTs, CoPACK

- 1.- GATE
2. 4.- COLLECTOR
- 3.- EMITTER

#### DIODES

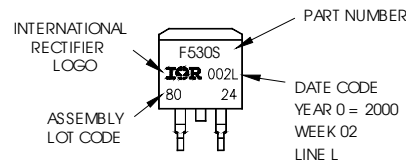
- 1.- ANODE \*
2. 4.- CATHODE
- 3.- ANODE

\* PART DEPENDENT.

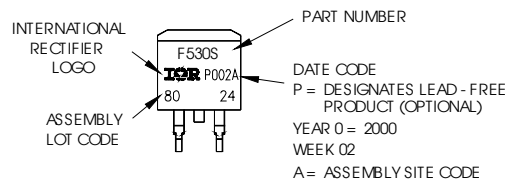
## D<sup>2</sup>Pak (TO-263AB) Part Marking Information

EXAMPLE: THIS IS AN IRF530S WITH  
LOT CODE 8024  
ASSEMBLED ON WW 02, 2000  
IN THE ASSEMBLY LINE "L"

Note: "P" in assembly line position  
indicates "Lead - Free"



OR

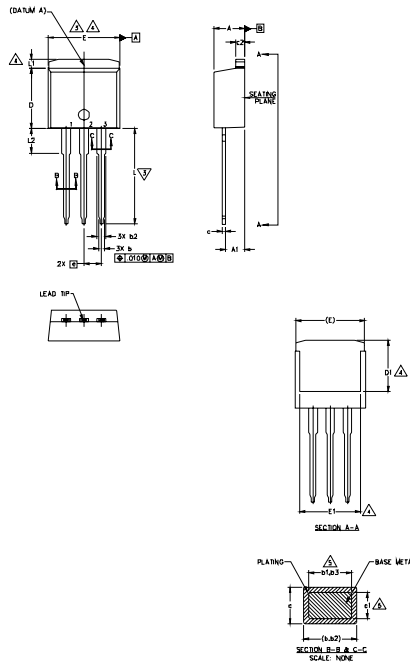


### Notes:

1. For an Automotive Qualified version of this part please see <http://www.irf.com/product-info/auto/>
2. For the most current drawing please refer to IR website at <http://www.irf.com/package/>

## TO-262 Package Outline

Dimensions are shown in millimeters (inches)



NOTES:

1. DIMENSIONING AND TOLERANCING PER ASME Y14.5M-1994
2. DIMENSIONS ARE SHOWN IN MILLIMETERS [INCHES]
3. DIMENSION D & E DO NOT INCLUDE MOLD FLASH. MOLD FLASH SHALL NOT EXCEED 0.127 [0.005"] PER SIDE. THESE DIMENSIONS ARE MEASURED AT THE OUTMOST EXTREMES OF THE PLASTIC BODY.
4. THERMAL PAD CONTOUR OPTIONAL WITHIN DIMENSION E, L1, D1 & E1.
5. DIMENSION b1 AND c1 APPLY TO BASE METAL ONLY.
6. CONTROLLING DIMENSION: INCH.
7. OUTLINE CONFORM TO JEDEC TO-262 EXCEPT A1(max.), b(min.) AND D1(min.) WHERE DIMENSIONS DERIVED THE ACTUAL PACKAGE OUTLINE.

SYMBOL	DIMENSIONS				NOTES
	MILLIMETERS		INCHES		
	MIN.	MAX.	MIN.	MAX.	
A	4.06	4.83	.160	.190	
A1	2.03	3.02	.080	.119	
b	0.51	0.99	.020	.039	
b1	0.51	0.89	.020	.035	5
b2	1.14	1.78	.045	.070	
b3	1.14	1.73	.045	.068	5
c	0.38	0.74	.015	.029	
c1	0.38	0.58	.015	.023	5
c2	1.14	1.65	.045	.065	
D	8.38	9.65	.330	.380	3
D1	6.86	-	.270	-	4
E	9.65	10.67	.380	.420	3,4
E1	6.22	-	.245	-	4
e	2.54	BSC	.100	BSC	
L	13.46	14.10	.530	.555	
L1	-	1.65	-	.065	
L2	3.56	3.71	.140	.146	

LEAD ASSIGNMENTS

HEXFET

- 1.- GATE
- 2.- DRAIN
- 3.- SOURCE
- 4.- DRAIN

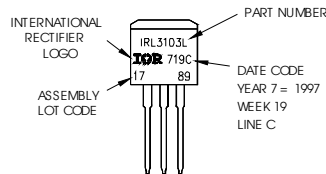
IGBTs, CoPACK

- 1.- GATE
- 2.- COLLECTOR
- 3.- EMITTER
- 4.- COLLECTOR

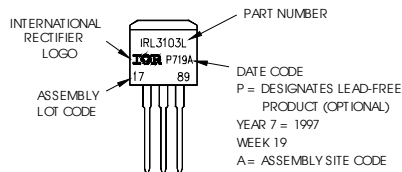
## TO-262 Part Marking Information

EXAMPLE: THIS IS AN IRL3103L  
LOT CODE 1789  
ASSEMBLED ON WW 19, 1997  
IN THE ASSEMBLY LINE "C"

Note: "P" in assembly line position  
indicates "Lead - Free"



OR



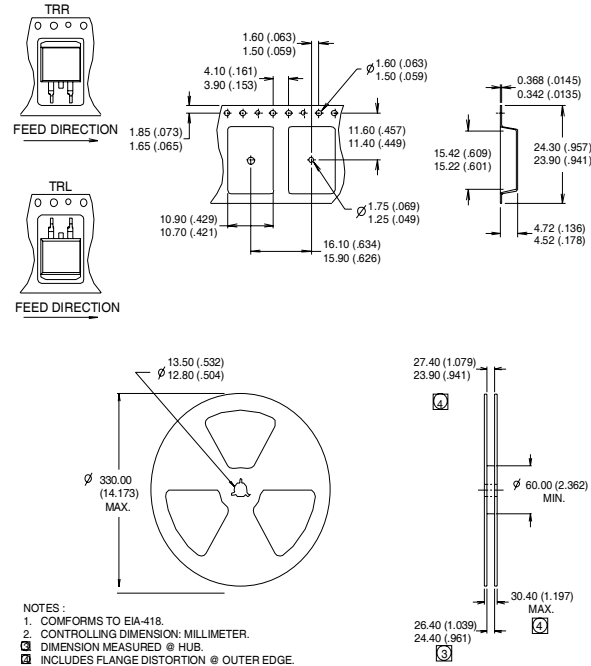
Notes:

1. For an Automotive Qualified version of this part please see <http://www.irf.com/product-info/automotive/>
2. For the most current drawing please refer to IR website at <http://www.irf.com/package/>

# IRFZ44VZS/LPbF

International  
**IR** Rectifier

## D<sup>2</sup>Pak Tape & Reel Infomation



### Notes:

- ① Repetitive rating; pulse width limited by max. junction temperature. (See fig. 11).
- ② Limited by  $T_{Jmax}$ , starting  $T_J = 25^\circ C$ ,  $L = 0.12mH$ ,  $R_G = 25\Omega$ ,  $I_{AS} = 34A$ ,  $V_{GS} = 10V$ . Part not recommended for use above this value.
- ③ Pulse width  $\leq 1.0ms$ ; duty cycle  $\leq 2\%$ .
- ④  $C_{oss}$  eff. is a fixed capacitance that gives the same charging time as  $C_{oss}$  while  $V_{DS}$  is rising from 0 to 80%  $V_{DSS}$ .
- ⑤ Limited by  $T_{Jmax}$ , see Fig.12a, 12b, 15, 16 for typical repetitive avalanche performance.
- ⑥ This value determined from sample failure population. 100% tested to this value in production.
- ⑦ This is only applied to TO-220AB package.
- ⑧ This is applied to D<sup>2</sup>Pak, when mounted on 1" square PCB (FR-4 or G-10 Material). For recommended footprint and soldering techniques refer to application note #AN-994.

Data and specifications subject to change without notice.  
 This product has been designed and qualified for the Industrial market.  
 Qualification Standards can be found on IR's Web site.

International  
**IR** Rectifier

IR WORLD HEADQUARTERS: 233 Kansas St., El Segundo, California 90245, USA Tel: (310) 252-7105  
 TAC Fax: (310) 252-7903

Visit us at [www.irf.com](http://www.irf.com) for sales contact information. 09/2010

[www.irf.com](http://www.irf.com)

## **IMPORTANT NOTICE**

The information given in this document shall in no event be regarded as a guarantee of conditions or characteristics ("Beschaffheitsgarantie").

With respect to any examples, hints or any typical values stated herein and/or any information regarding the application of the product, Infineon Technologies hereby disclaims any and all warranties and liabilities of any kind, including without limitation warranties of non-infringement of intellectual property rights of any third party.

In addition, any information given in this document is subject to customer's compliance with its obligations stated in this document and any applicable legal requirements, norms and standards concerning customer's products and any use of the product of Infineon Technologies in customer's applications.

The data contained in this document is exclusively intended for technically trained staff. It is the responsibility of customer's technical departments to evaluate the suitability of the product for the intended application and the completeness of the product information given in this document with respect to such application.

For further information on the product, technology, delivery terms and conditions and prices please contact your nearest Infineon Technologies office ([www.infineon.com](http://www.infineon.com)).

## **WARNINGS**

Due to technical requirements products may contain dangerous substances. For information on the types in question please contact your nearest Infineon Technologies office.

Except as otherwise explicitly approved by Infineon Technologies in a written document signed by authorized representatives of Infineon Technologies, Infineon Technologies' products may not be used in any applications where a failure of the product or any consequences of the use thereof can reasonably be expected to result in personal injury.