



Pb-free  
HEAT



## 105/107 Series

Numeric Display/ Case Size 22.8 x 33.0 mm

### Features

Case Size	22.8 x 33.0 mm (W x H)
Product features	<ul style="list-style-type: none"><li>• Each color has anode common and cathode common respectively.</li><li>• A black case and a gray case are available.</li><li>• No lead package</li><li>• Lead-free soldering compatible</li></ul>
Peak wavelength	Green : 565nm Orange : 605nm Red : 660nm
Number of Digit	1 Digit
Segment Shape	Arrow Feather Type
Character Height	25.4 mm
Die materials	Green : GaP Orange : GaAsP Red : GaAlAs
Soldering methods	TTW (Through The Wave) soldering and manual soldering
ESD	More than 2kV(HBM)
Packing	Tray

### Recommended Applications

Amusement Equipment, Electric Household Appliances, Other General Applications

## Emitted Color

Part No.				Material	Emitted Color	※1 Chip/ Segment
Anode Common		Cathode Common				
Case Color Black	Case Color Gray	Case Color Black	Case Color Gray			
NAG105P	NAG107P	NKG105P	NKG107P	GaP	Green	2
						1
NAA105	NAA107	NKA105	NKA107	GaAsP	Orange	2
						1
NAR105	NAR107	NKR105	NKR107	GaAlAs	Red	2
						1

※1 Segment NO. a, b, c, d, e, f, g : 2 chips / Segment  
 Segment NO. D.P : 1 chip / Segment

## Absolute Maximum Ratings

(Ta=25°C)

Item	Symbol	Absolute Maximum Ratings						Unit
		Green		Orange		Red		
		Chip / Segment						
		2	1	2	1	2	1	
Power Dissipation	Pd	126	63	126	63	120	60	mW/seg
Forward Current	I <sub>F</sub>	25		25		30		mA/seg
Pulse Forward Current ※2	I <sub>FRM</sub>	100		100		120		mA/seg
Derating (Ta=25°C or higher)	ΔI <sub>F</sub>	0.34		0.34		0.41		mA/°C
	ΔI <sub>FRM</sub>	1.35		1.35		1.64		mA/°C
Reverse Voltage	V <sub>R</sub>	8	4	8	4	8	4	V
Operating Temperature	T <sub>opr</sub>	-20 ~ +85		-20 ~ +85		-20 ~ +85		°C
Storage Temperature	T <sub>sta</sub>	-20 ~ +85		-20 ~ +85		-20 ~ +85		°C

※2 I<sub>FRM</sub> Measurement condition : Duty 1/5, f = 1kHz

## Electro-Optical Characteristics

(Ta=25°C)

Item	Conditions	Symbol		Characteristics						Unit
				Green		Orange		Red		
				Chip / Segment						
				2	1	2	1	2	1	
Luminous Intensity(Rank B)	I <sub>F</sub> =20mA	I <sub>V</sub>	MIN.	4	2	8	4	10	5	mcd/seg
			TYP.	8	4	16	8	20	10	
Luminous Intensity(Rank C)	I <sub>F</sub> =20mA	I <sub>V</sub>	MIN.	-		-		20	10	mcd/seg
			TYP.	-		-		25	12.5	
Forward Voltage	I <sub>F</sub> =20mA	V <sub>F</sub>	TYP.	4.4	2.2	4.4	2.2	3.4	1.7	V/seg
			MAX.	5.0	2.5	5.0	2.5	4.0	2.0	
Reverse Current	-	I <sub>R</sub>	MAX.	100 (V <sub>R</sub> =8V)	100 (V <sub>R</sub> =4V)	100 (V <sub>R</sub> =8V)	100 (V <sub>R</sub> =4V)	100 (V <sub>R</sub> =8V)	100 (V <sub>R</sub> =4V)	μ A/seg
Peak Wavelength	I <sub>F</sub> =20mA	λ <sub>p</sub>	TYP.	565		605		660		nm
Spectral Line Half Width	I <sub>F</sub> =20mA	Δλ	TYP.	30		30		30		nm

## Technical Data(Green)

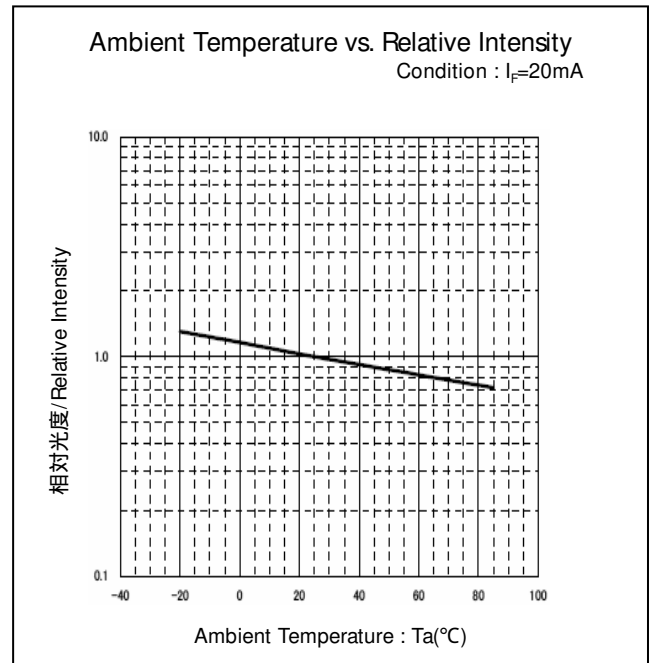
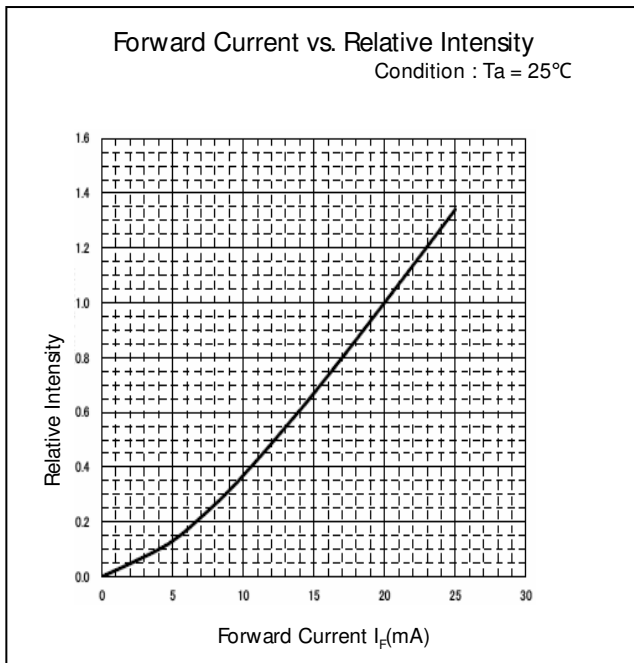
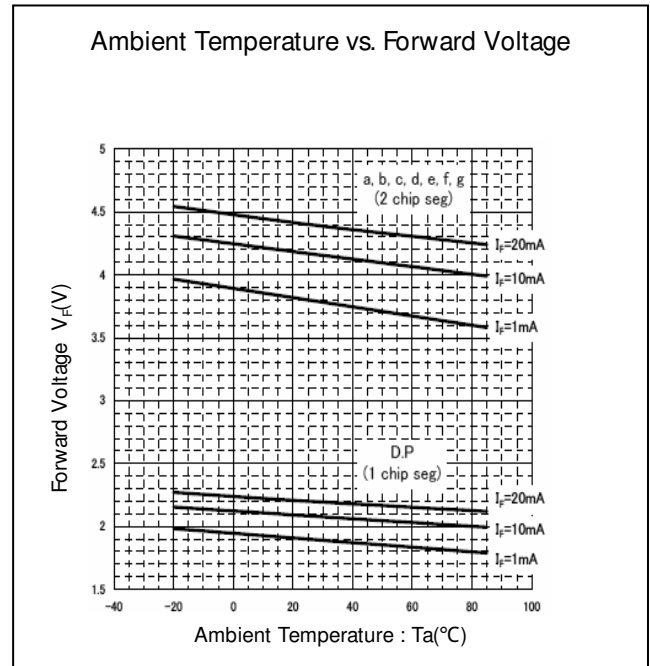
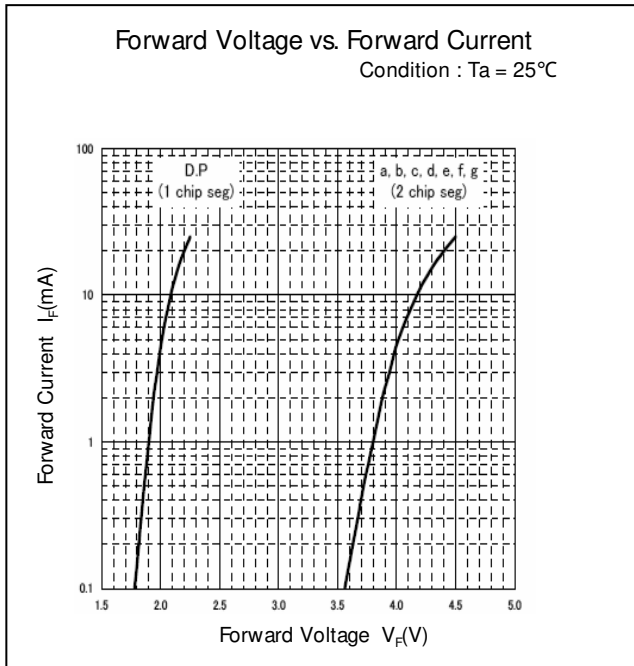

## Technical Data(Green)

Ambient Temperature vs. Maximum Forward Current

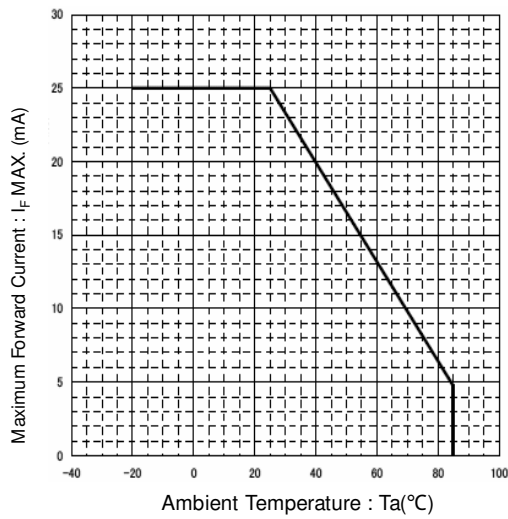

Ambient Temperature vs. Power Dissipation

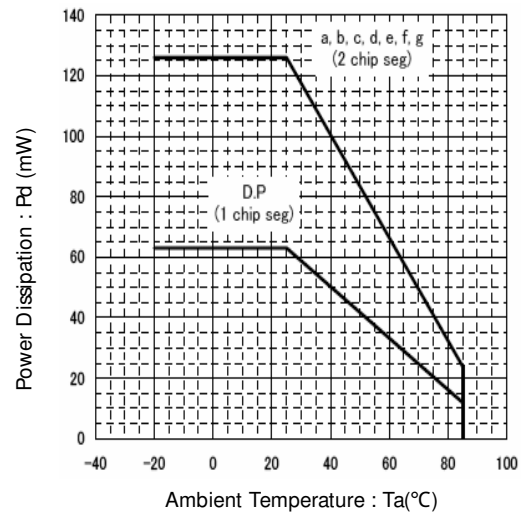

Duty Factor vs. Maximum Tolerable Pulse Forward Current  
Condition : Ta = 25°C

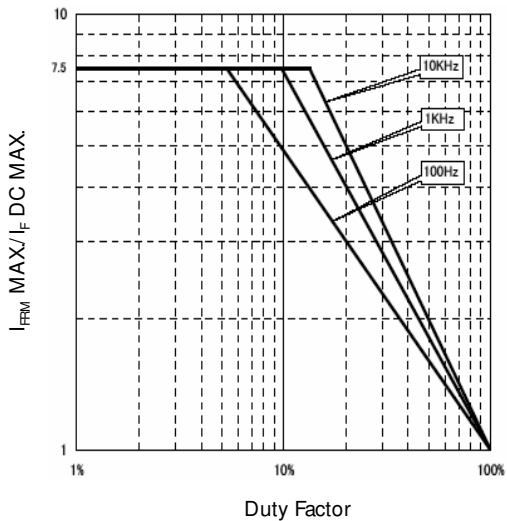

## Technical Data(Orange)

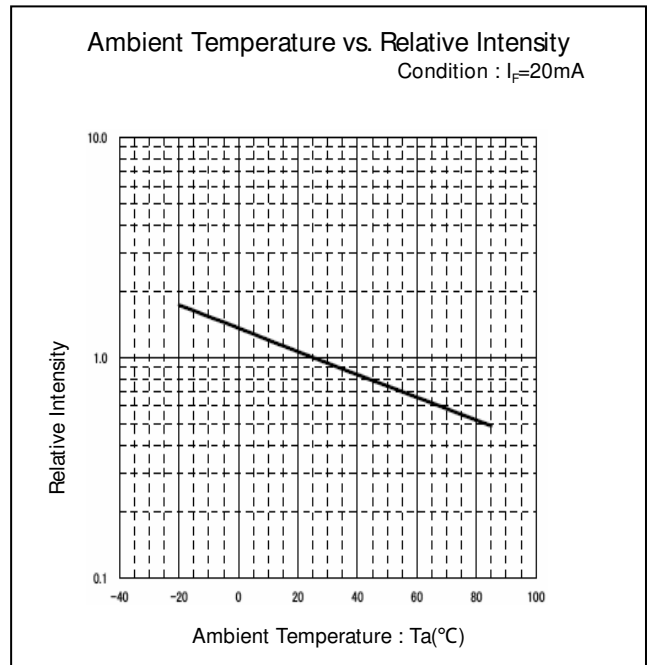
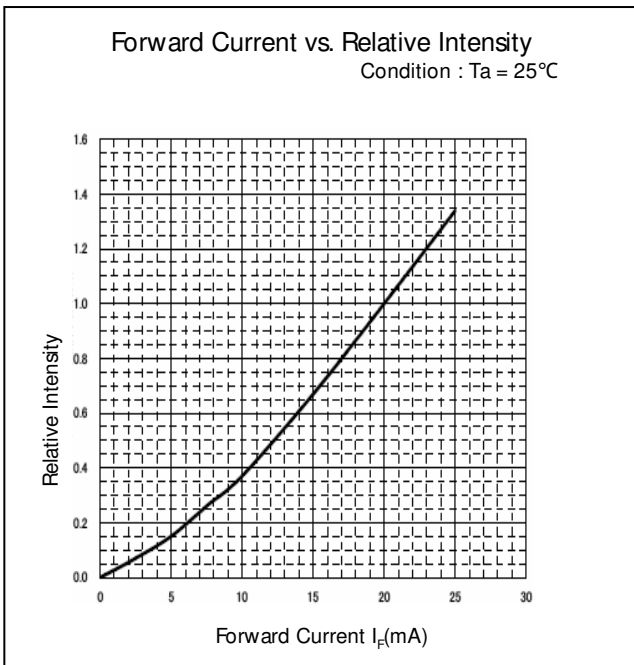
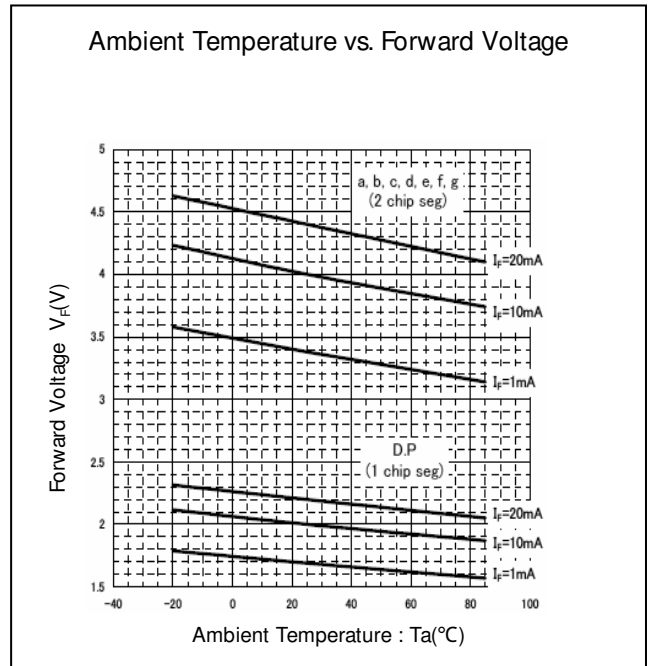
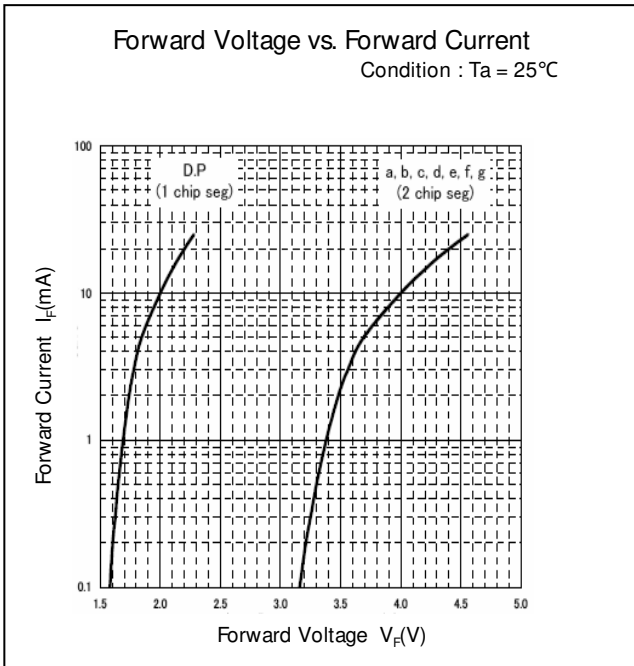

## Technical Data(Orange)

Ambient Temperature vs. Maximum Forward Current

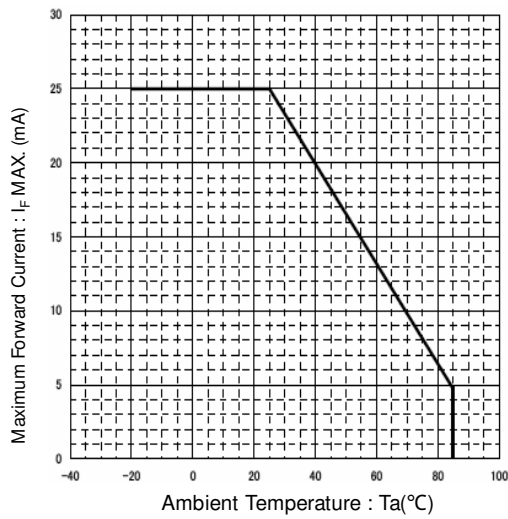

Ambient Temperature vs. Power Dissipation

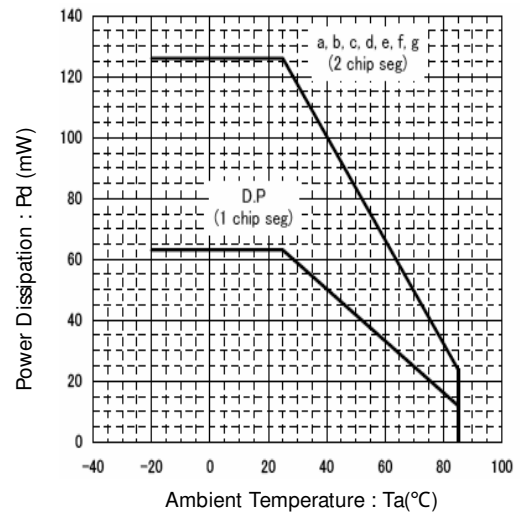

Duty Factor vs. Maximum Tolerable Pulse Forward Current  
Condition : Ta = 25°C

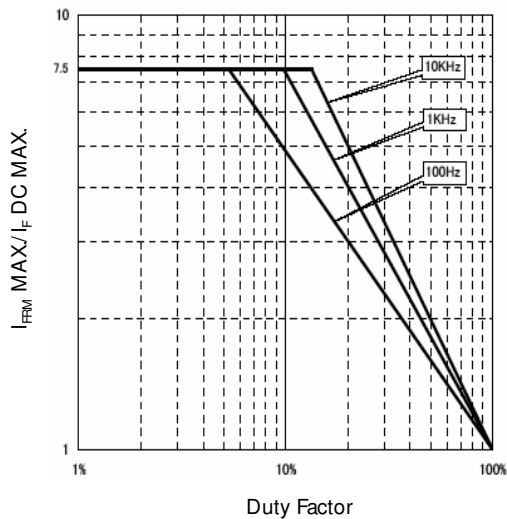

## Technical Data(Red)

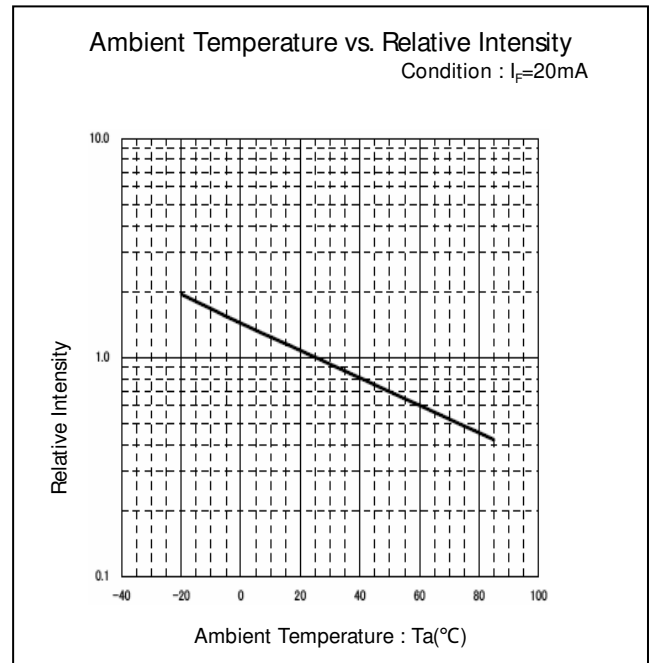
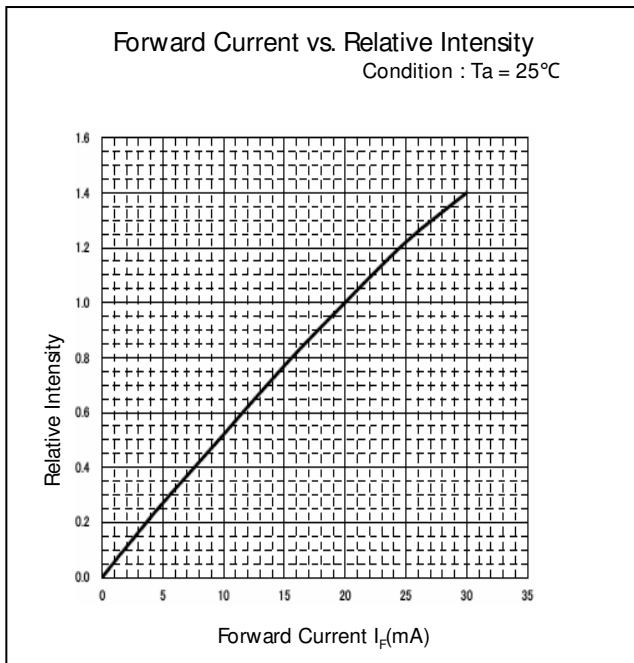
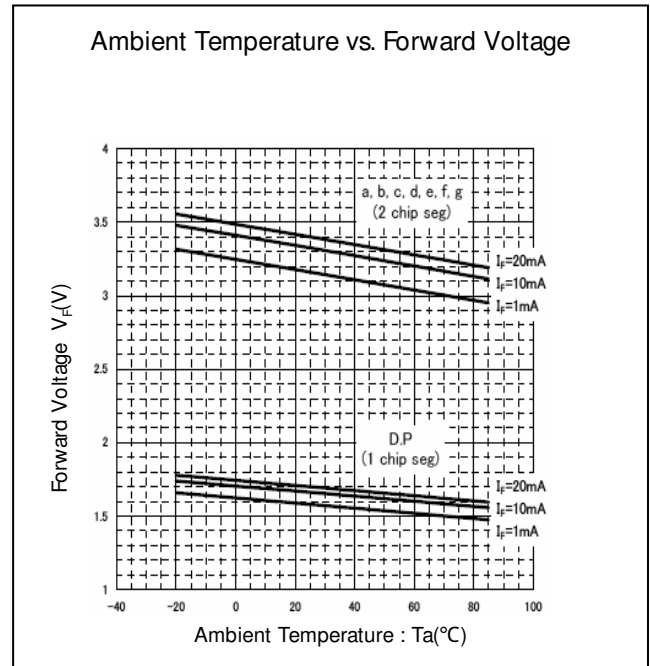
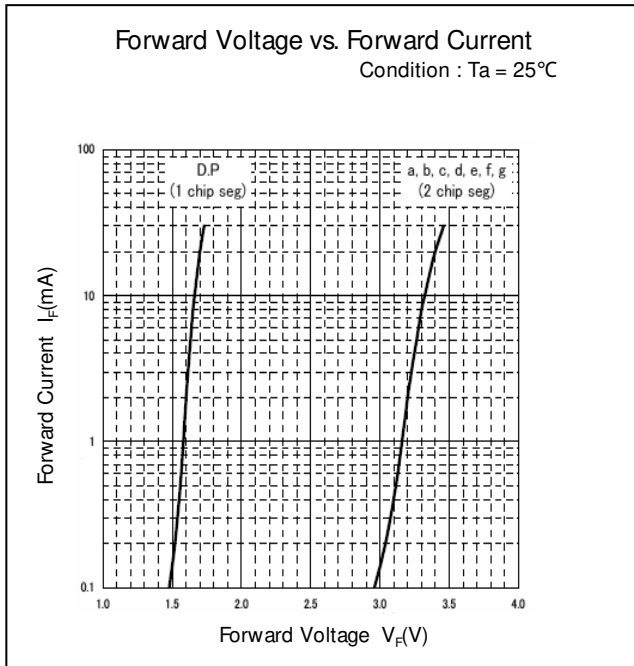

## Technical Data(Red)

Ambient Temperature vs. Maximum Forward Current

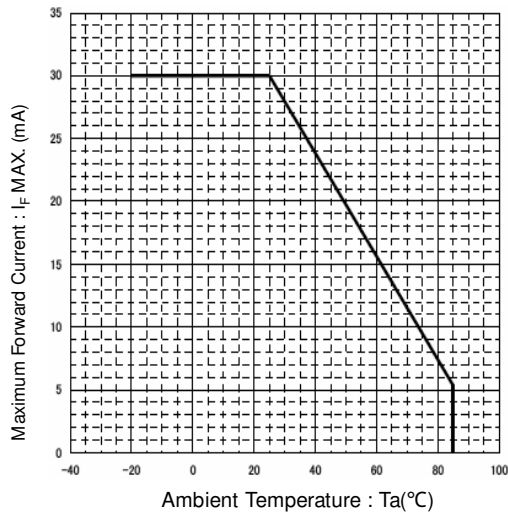

Ambient Temperature vs. Power Dissipation

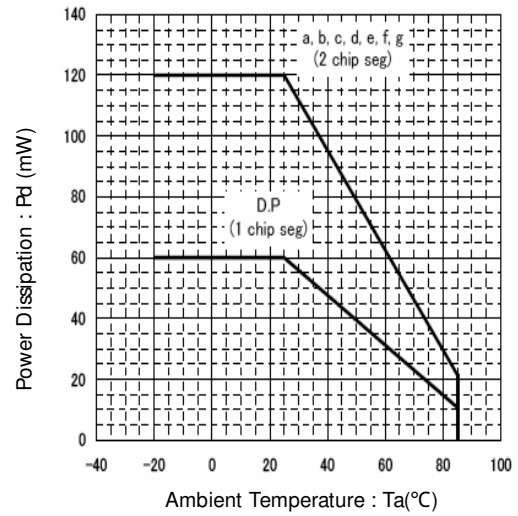

Duty Factor vs. Maximum Tolerable Pulse Forward Current  
Condition : Ta = 25°C

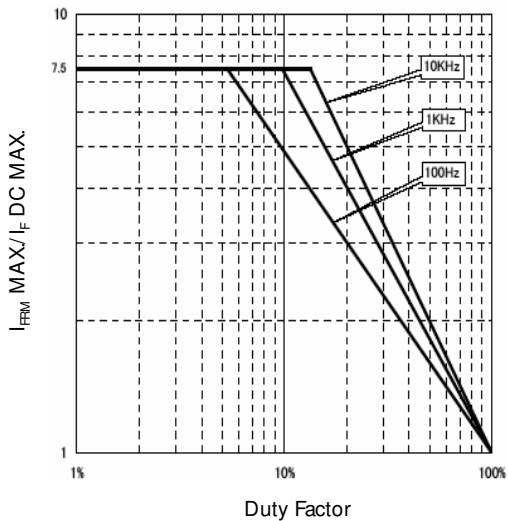



## Package Dimensions

(Unit: mm)

(Tolerance : ± 0.25 mm)

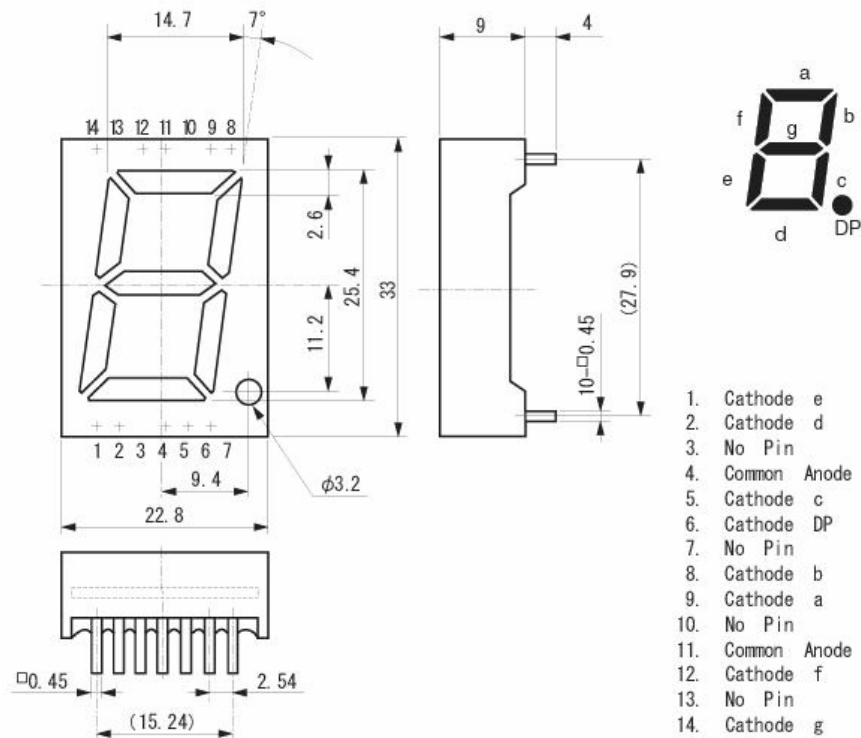

- Cathode common types have a reverse polarity.

## TTW (Through The Wave) soldering Conditions

---

Pre-heating	100 °C 60 s	(MAX.) Resin surface temperature (MAX.)
Solder Bath Temp.	265 °C	(MAX.)
Dipping Time	5 s	(MAX.)
Position	At least 2.0 mm away from resin body	

- 1) The dip soldering process shall be 2 times maximum.
- 2) The product shall be cooled to normal temperature before the second dipping process.

## Manual Soldering Conditions

---

Iron tip temp.	400 °C	(MAX.) (30 W Max.)
Soldering time and frequency	3 s 2 times	(MAX.) (MAX.)
Position	At least 2.0 mm away from resin body	

## Reliability Testing Result

Reliability Testing Result	Applicable Standard	Testing Conditions	Duration	Failure
Room Temp. Operating Life	EIAJED-4701/100(101)	Ta = 25°C, If = Maximum Rated Current/seg	1,000 h	0/10
Resistance to Soldering Heat	EIAJED-4701/300(302)	260±5°C, 3mm from package base	10s	0/10
Temperature Cycling	EIAJED-4701/100(105)	Minimum Rated Storage Temperature(30min) ~Normal Temperature(15min) ~Maximum Rated Storage Temperature(30min) ~Normal Temperature(15min)	5 cycles	0/10
Wet High Temp. Storage Life	EIAJED-4701/100(103)	Ta = 60±2°C, RH = 90±5%	1,000 h	0/10
High Temp. Storage Life	EIAJED-4701/200(201)	Ta = Maximum Rated Storage Temperature	1,000 h	0/10
Low Temp. Storage Life	EIAJED-4701/200(202)	Ta = Minimum Rated Storage Temperature	1,000 h	0/10
Lead Tension	EIAJED-4701/400(401)	5N, 1time	10s	0/10
Vibration, Variable Frequency	EIAJED-4701/400(403)	98.1m/s <sup>2</sup> (10G), 100 ~ 2KHz sweep for 20min., XYZ each direction	2 h	0/10
Lead Bend	EIAJED-4701/400(401)	2.5N, 0° ↔ 90°	2 times	0/10
Shock	JISC 7201 A-8	It falls on wood engraving from height of 75cm.	3 times	0/10

## Failure Criteria

Items	Symbols	Conditions	Failure criteria
Luminous Intensity	Iv	If Value of each product Luminous Intensity	Testing Min. Value < Spec. Min. Value x 0.5
Forward Voltage	V <sub>F</sub>	If Value of each product Forward Voltage	Testing Max. Value ≥ Spec. Max. Value x 1.2
Reverse Current	I <sub>R</sub>	V <sub>R</sub> = Maximum Rated Reverse Voltage V	Testing Max. Value ≥ Spec. Max. Value x 2.5
Cosmetic Appearance	-	-	No notable, decoloration, deformation and cracking

## Special Notice to Customers Using the Products and Technical Information Shown in This Data Sheet

---

- 1) The technical information shown in the data sheets are limited to the typical characteristics and circuit examples of the referenced products. It does not constitute the warranting of industrial property nor the granting of any license.
- 2) For the purpose of product improvement, the specifications, characteristics and technical data described in the data sheets are subject to change without prior notice. Therefore it is recommended that the most updated specifications be used in your design.
- 3) When using the products described in the data sheets, please adhere to the maximum ratings for operating voltage, heat dissipation characteristics, and other precautions for use. We are not responsible for any damage which may occur if these specifications are exceeded.
- 4) The products described in the data sheets are made to be used in standard electronic applications such as office automation appliances, communication devices, audio visual, home appliances, and measuring instruments.
- 5) If the products in the data sheets are to be used for purposes other than the above which requires high level reliability and safety where failure and or malfunction of the product may cause death or other serious effects on the human body such as airplane, space activity, transportation, medical, nuclear), please contact our sales personnel.
- 6) In order to export the products or technologies described in this data sheet which are under the "Foreign Exchange and Foreign Trade Control Law," it is necessary to first obtain an export permit from the Japanese government.
- 7) No part of this data sheet may be reprinted or reproduced without prior written permission from Stanley Electric Co., Ltd.
- 8) The most updated edition of this data sheet can be obtained from the address below:  
<http://www.stanley-components.com>