

FMG1G400US60H

Molding Type Module

General Description

Fairchild IGBT Power Module provides low conduction and switching losses as well as short circuit ruggedness. It's designed for the applications such as motor control, uninterrupted power supplies (UPS) and general inverters where short-circuit ruggedness is required.

Features

- Short Circuit Rated Time; 10us @ $T_C = 100^\circ\text{C}$, $V_{GE} = 15\text{V}$
- High Speed Switching
- Low Saturation Voltage : $V_{CE(sat)} = 2.1\text{V}$ @ $I_C = 400\text{A}$
- High Input Impedance
- Fast & Soft Anti-Parallel FWD
- UL Certified No.E209204

Application

- AC & DC Motor Controls
- General Purpose Inverters
- Robotics
- Servo Controls
- UPS

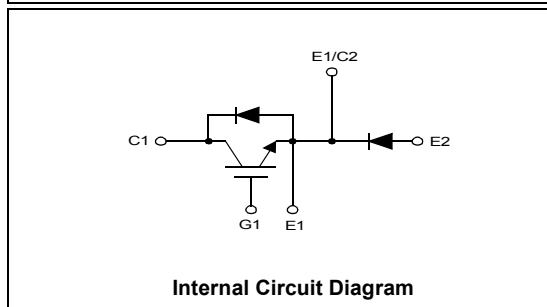
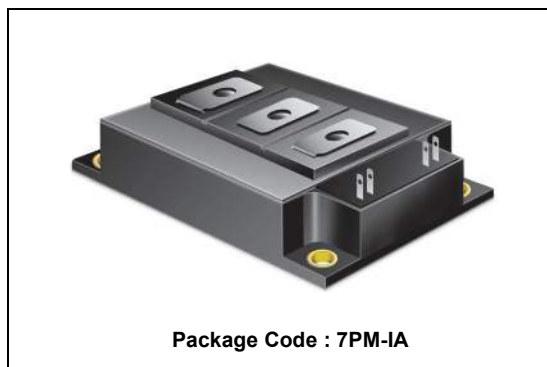

Absolute Maximum Ratings $T_C = 25^\circ\text{C}$ unless otherwise noted

Symbol	Description	FMG1G400US60H	Units
V_{CES}	Collector-Emitter Voltage	600	V
V_{GES}	Gate-Emitter Voltage	± 20	V
I_C	Collector Current @ $T_C = 80^\circ\text{C}$	400	A
$I_{CM(1)}$	Pulsed Collector Current	800	A
I_F	Diode Continuous Forward Current @ $T_C = 80^\circ\text{C}$	400	A
I_{FM}	Diode Maximum Forward Current	800	A
P_D	Maximum Power Dissipation @ $T_C = 25^\circ\text{C}$	1136	W
T_{SC}	Short Circuit Withstand Time @ $T_C = 100^\circ\text{C}$	10	us
T_J	Operating Junction Temperature	-40 to +150	$^\circ\text{C}$
T_{STG}	Storage Temperature Range	-40 to +125	$^\circ\text{C}$
V_{ISO}	Isolation Voltage @ AC 1minute	2500	V
Mounting Torque	Power Terminal Screw : M6	4.0	N.m
	Mounting Screw : M6	4.0	N.m

Notes :

(1) Repetitive rating : Pulse width limited by max. junction temperature

Electrical Characteristics of IGBT T_C = 25°C unless otherwise noted

Symbol	Parameter	Test Conditions	Min.	Typ.	Max.	Units
Off Characteristics						
BV _{CES}	Collector-Emitter Breakdown Voltage	V _{GE} = 0V, I _C = 250uA	600	--	--	V
ΔBV _{CES} /ΔT _J	Temperature Coeff. of Breakdown Voltage	V _{GE} = 0V, I _C = 1mA	--	0.6	--	V/°C
I _{CES}	Collector Cut-Off Current	V _{CE} = V _{CES} , V _{GE} = 0V	--	--	250	uA
I _{GES}	Gate - Emitter Leakage Current	V _{GE} = V _{GES} , V _{CE} = 0V	--	--	± 100	nA

On Characteristics

V _{GE(th)}	Gate - Emitter Threshold Voltage	I _C = 400mA, V _{CE} = V _{GE}	5.0	6.5	8.5	V
V _{CE(sat)}	Collector to Emitter Saturation Voltage	I _C = 400A, V _{GE} = 15V	--	2.1	2.7	V

Switching Characteristics

t _{d(on)}	Turn-On Delay Time	V _{CC} = 300 V, I _C = 400A, R _G = 2Ω, V _{GE} = 15V, Inductive Load, T _C = 25°C	--	160	--	ns
t _r	Rise Time		--	220	--	ns
t _{d(off)}	Turn-Off Delay Time		--	230	--	ns
t _f	Fall Time		--	150	250	ns
E _{on}	Turn-On Switching Loss		--	9.5	--	mJ
E _{off}	Turn-Off Switching Loss	--	21	--	mJ	
t _{d(on)}	Turn-On Delay Time	V _{CC} = 300 V, I _C = 400A, R _G = 2Ω, V _{GE} = 15V, Inductive Load, T _C = 125°C	--	320	--	ns
t _r	Rise Time		--	240	--	ns
t _{d(off)}	Turn-Off Delay Time		--	290	--	ns
t _f	Fall Time		--	230	--	ns
E _{on}	Turn-On Switching Loss		--	11	--	mJ
E _{off}	Turn-Off Switching Loss	--	26	--	mJ	
T _{sc}	Short Circuit Withstand Time	V _{CC} = 300 V, V _{GE} = 15V @ T _C = 100°C	10	--	--	us
Q _g	Total Gate Charge	V _{CE} = 300 V, I _C = 400A, V _{GE} = 15V	--	1200	--	nC
Q _{ge}	Gate-Emitter Charge		--	310	--	nC
Q _{gc}	Gate-Collector Charge		--	490	--	nC

Electrical Characteristics of DIODE T_C = 25°C unless otherwise noted

Symbol	Parameter	Test Conditions	Min.	Typ.	Max.	Units	
V _{FM}	Diode Forward Voltage	I _F = 400A	T _C = 25°C	--	1.9	2.8	V
			T _C = 100°C	--	1.8	--	
t _{rr}	Diode Reverse Recovery Time	I _F = 400A	T _C = 25°C	--	90	130	ns
			T _C = 100°C	--	130	--	
I _{rr}	Diode Peak Reverse Recovery Current	di / dt = 800 A/us	T _C = 25°C	--	35	46	A
			T _C = 100°C	--	76	--	
Q _{rr}	Diode Reverse Recovery Charge	I _F = 400A	T _C = 25°C	--	1580	3000	nC
			T _C = 100°C	--	4940	--	

Thermal Characteristics

Symbol	Parameter	Typ.	Max.	Units
R _{θJC}	Junction-to-Case (IGBT Part, per 1/2 Module)	--	0.11	°C/W
R _{θJC}	Junction-to-Case (DIODE Part, per 1/2 Module)	--	0.18	°C/W
R _{θJC}	Case-to-Sink (Conductive grease applied)	0.03	--	°C/W
Weight	Weight of Module	360	--	g

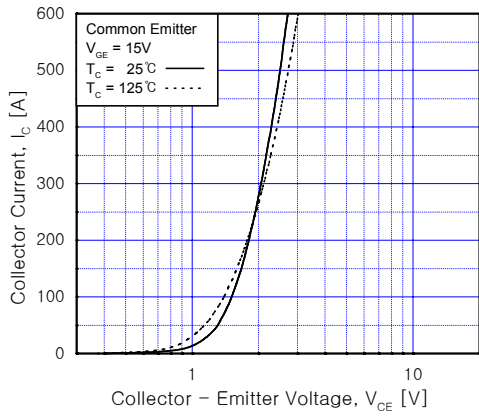

Fig 1. Typical Output Characteristics

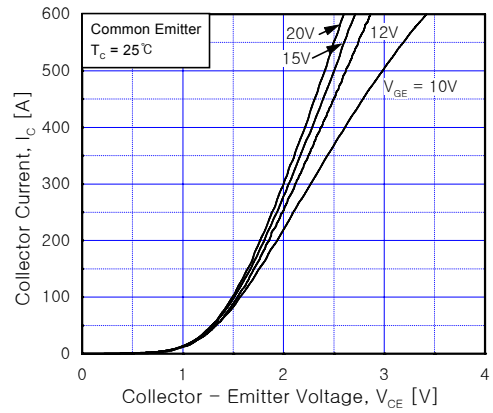

Fig 2. Typical Saturation Voltage Characteristics

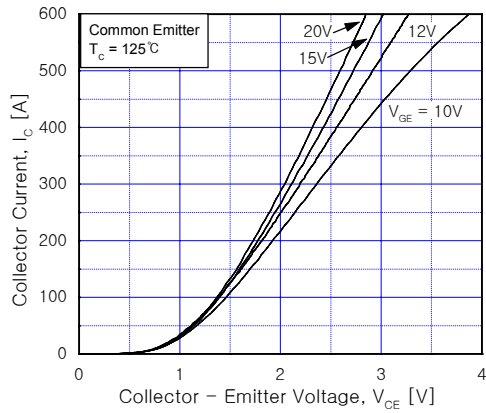

Fig 3. Typical Saturation Voltage Characteristics

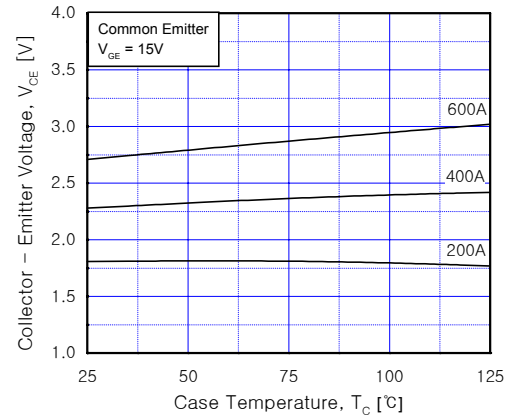

Fig 4. Saturation Voltage vs. Case Temperature at Variant Current Level

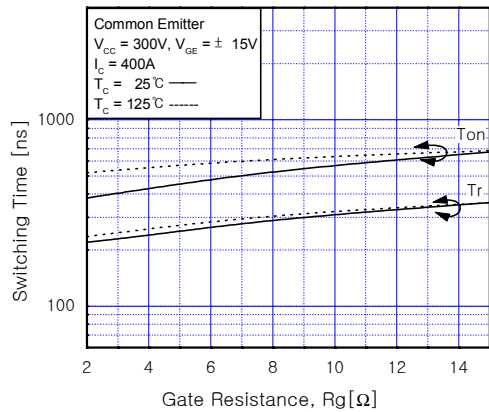

Fig 5. Turn-On Characteristics vs. Gate Resistance

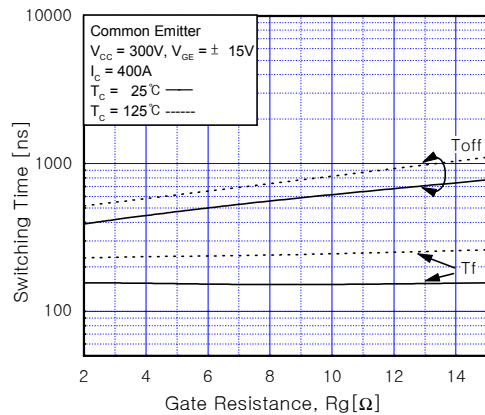

Fig 6. Turn-Off Characteristics vs. Gate Resistance

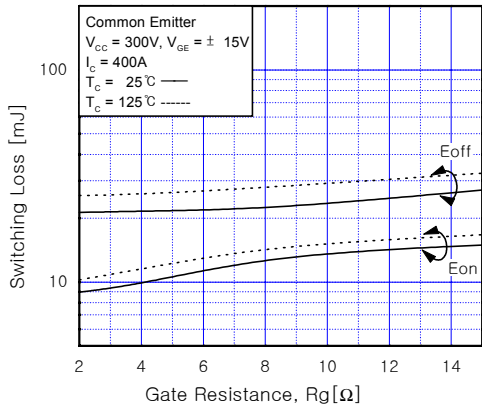

Fig 7. Switching Loss vs. Gate Resistance

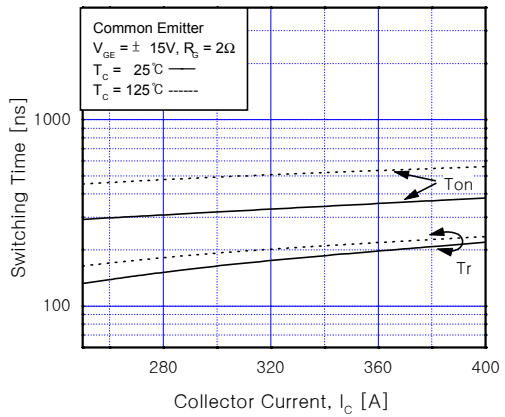

Fig 8. Turn-On Characteristics vs. Collector Current

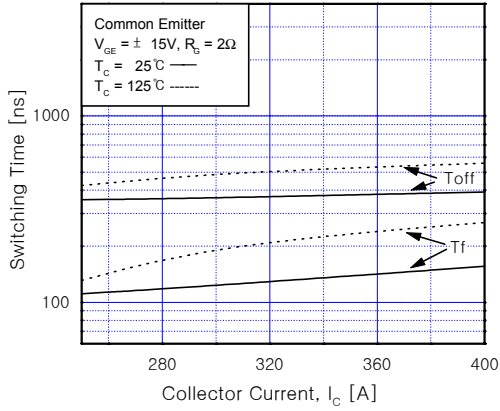

Fig 9. Turn-Off Characteristics vs. Collector Current

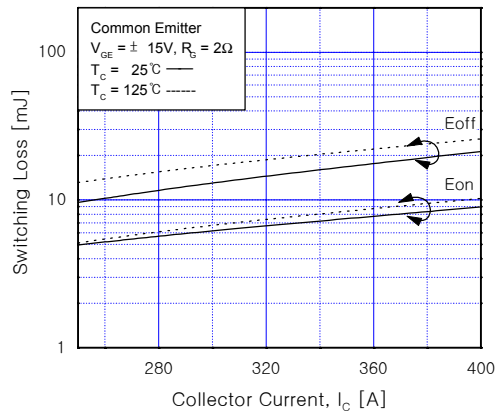

Fig 10. Switching Loss vs. Collector Current

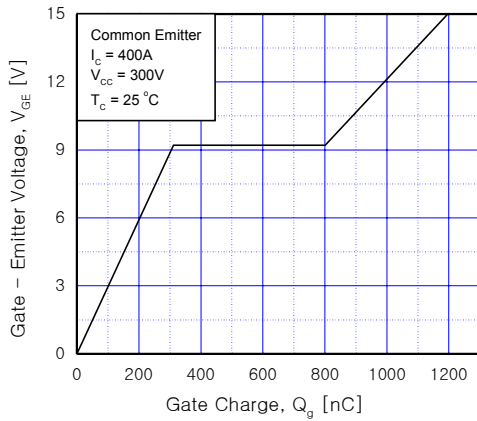

Fig 11. Gate Charge Characteristics

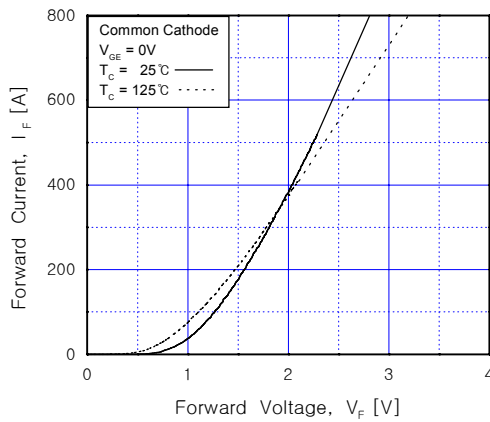

Fig 12. Forward Characteristics (diode)

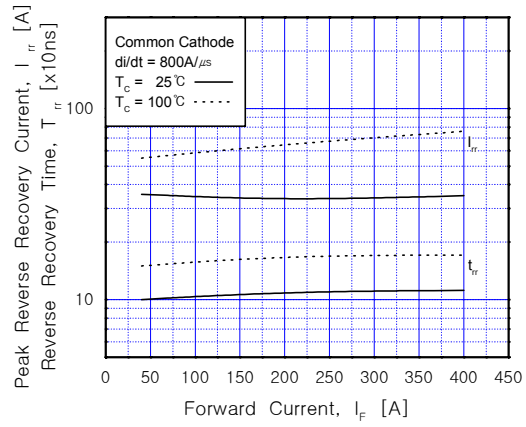
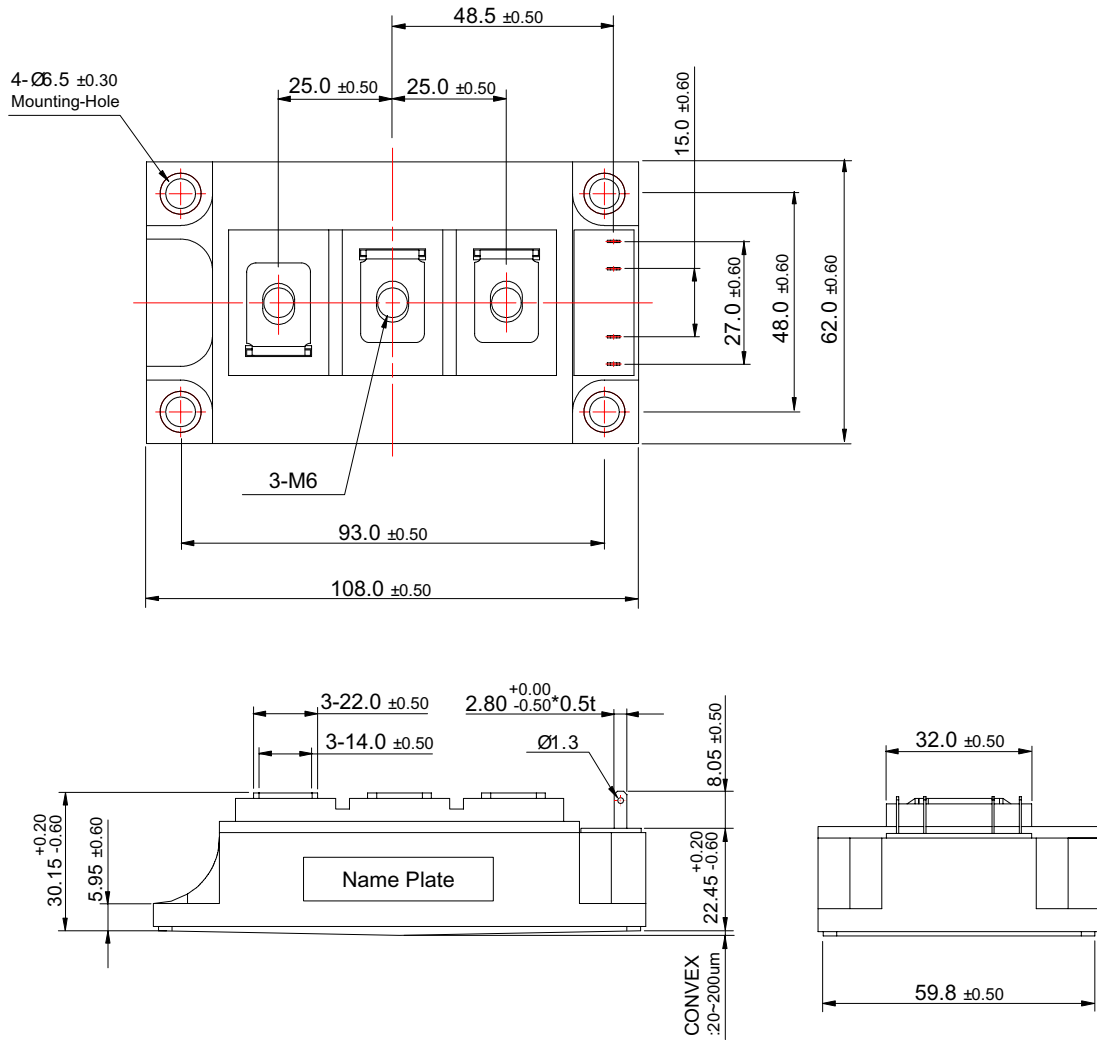

Fig 13. Reverse Recovery Characteristics(diode)

Package Dimension

7PM-IA



Dimensions in Millimeters

TRADEMARKS

The following are registered and unregistered trademarks Fairchild Semiconductor owns or is authorized to use and is not intended to be an exhaustive list of all such trademarks.

ACE ^x TM	FACT Quiet series TM	ISOPLANAR TM	POP TM	SuperFET TM
ActiveArray TM	FAST [®]	LittleFET TM	Power247 TM	SuperSOT TM -.3
Bottomless TM	FAST ^r TM	MICROCOUPLER TM	PowerTrench [®]	SuperSOT TM -.6
CoolFET TM	FPS TM	MicroFET TM	QFET TM	SuperSOT TM -.8
CROSSVOLT TM	FRFET TM	MicroPak TM	QS TM	SyncFET TM
DOME TM	GlobalOptoisolator TM	MICROWIRE TM	QT Optoelectronics TM	TinyLogic [®]
EcoSPARK TM	GTO TM	MSX TM	Quiet Series TM	TINYOPTO TM
E ² CMOS TM	HiSeC TM	MSXPro TM	RapidConfigure TM	TruTranslation TM
EnSigna TM	I ² C TM	OCX TM	RapidConnect TM	UHC TM
FACT TM	ImpliedDisconnect TM	OCXPro TM	SILENT SWITCHER [®]	UltraFET [®]
Across the board. Around the world. TM		OPTOLOGIC [®]	SMART START TM	VCX TM
The Power Franchise TM		OPTOPLANAR TM	SPM TM	
Programmable Active Droop TM		PACMAN TM	Stealth TM	

DISCLAIMER

FAIRCHILD SEMICONDUCTOR RESERVES THE RIGHT TO MAKE CHANGES WITHOUT FURTHER NOTICE TO ANY PRODUCTS HEREIN TO IMPROVE RELIABILITY, FUNCTION OR DESIGN. FAIRCHILD DOES NOT ASSUME ANY LIABILITY ARISING OUT OF THE APPLICATION OR USE OF ANY PRODUCT OR CIRCUIT DESCRIBED HEREIN; NEITHER DOES IT CONVEY ANY LICENSE UNDER ITS PATENT RIGHTS, NOR THE RIGHTS OF OTHERS.

LIFE SUPPORT POLICY

FAIRCHILD'S PRODUCTS ARE NOT AUTHORIZED FOR USE AS CRITICAL COMPONENTS IN LIFE SUPPORT DEVICES OR SYSTEMS WITHOUT THE EXPRESS WRITTEN APPROVAL OF FAIRCHILD SEMICONDUCTOR CORPORATION.

As used herein:

1. Life support devices or systems are devices or systems which, (a) are intended for surgical implant into the body, or (b) support or sustain life, or (c) whose failure to perform when properly used in accordance with instructions for use provided in the labeling, can be reasonably expected to result in significant injury to the user.
2. A critical component is any component of a life support device or system whose failure to perform can be reasonably expected to cause the failure of the life support device or system, or to affect its safety or effectiveness.

PRODUCT STATUS DEFINITIONS

Definition of Terms

Datasheet Identification	Product Status	Definition
Advance Information	Formative or In Design	This datasheet contains the design specifications for product development. Specifications may change in any manner without notice.
Preliminary	First Production	This datasheet contains preliminary data, and supplementary data will be published at a later date. Fairchild Semiconductor reserves the right to make changes at any time without notice in order to improve design.
No Identification Needed	Full Production	This datasheet contains final specifications. Fairchild Semiconductor reserves the right to make changes at any time without notice in order to improve design.
Obsolete	Not In Production	This datasheet contains specifications on a product that has been discontinued by Fairchild semiconductor. The datasheet is printed for reference information only.