

APPROVAL SHEET

RFBPF Series – 3225(1210)- RoHS Compliance

MULTILAYER CERAMIC BAND PASS FILTER

Halogens Free Product

475~675 MHz Band Application

P/N: RFBPF3225200Y07B1U

*Contents in this sheet are subject to change without prior notice.

FEATURES

1. Miniature footprint: 3.2 X 2.5 X 2.0 mm³
2. Low Insertion Loss
3. High Rejection
4. LTCC process

APPLICATIONS

1. 475 ~ 675 MHz Band application
2. For MoCA application

CONSTRUCTION

Top view

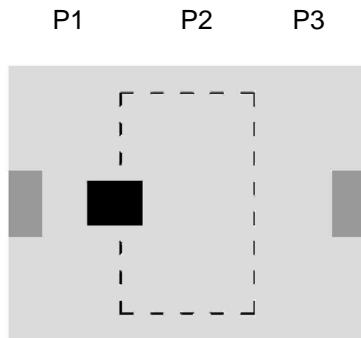

PIN	Connection
1	Input port
2	GND
3	Output port

DIMENSIONS

Figure	Symbol	Dimension (mm)
Top view 	L	3.20 ± 0.20
	W	2.50 ± 0.20
	T	2.00 max.
Bottom view 	A	0.95 ± 0.20
	B	0.60 ± 0.20
	C	0.30 ± 0.15
	D	0.70 ± 0.15
	E	1.20 ± 0.15
	F	2.00 ± 0.15

ELECTRICAL CHARACTERISTICS

RFBPF3225200Y07B1U	Specification
Frequency range	475 ~ 675 MHz
Insertion Loss	2.50 dB max. at +25°C 2.70 dB max. at -40°C ~ +85°C
VSWR	2.00 max
Port Impedance	75 Ω
Attenuation (min.)	60 dB @ 2.5 MHz 40 dB @ 2.5 ~ 100 MHz 35 dB @ 100 ~ 200 MHz 35 dB @ 200 ~ 300 MHz 8 dB @ 300 ~ 400 MHz 57 dB @ 950 MHz 47 dB @ 950 ~ 2025 MHz 41 dB @ 2025 ~ 2500 MHz 35 dB @ 2500 ~ 3000 MHz
Operation Temperature Range	-40°C ~ +85°C

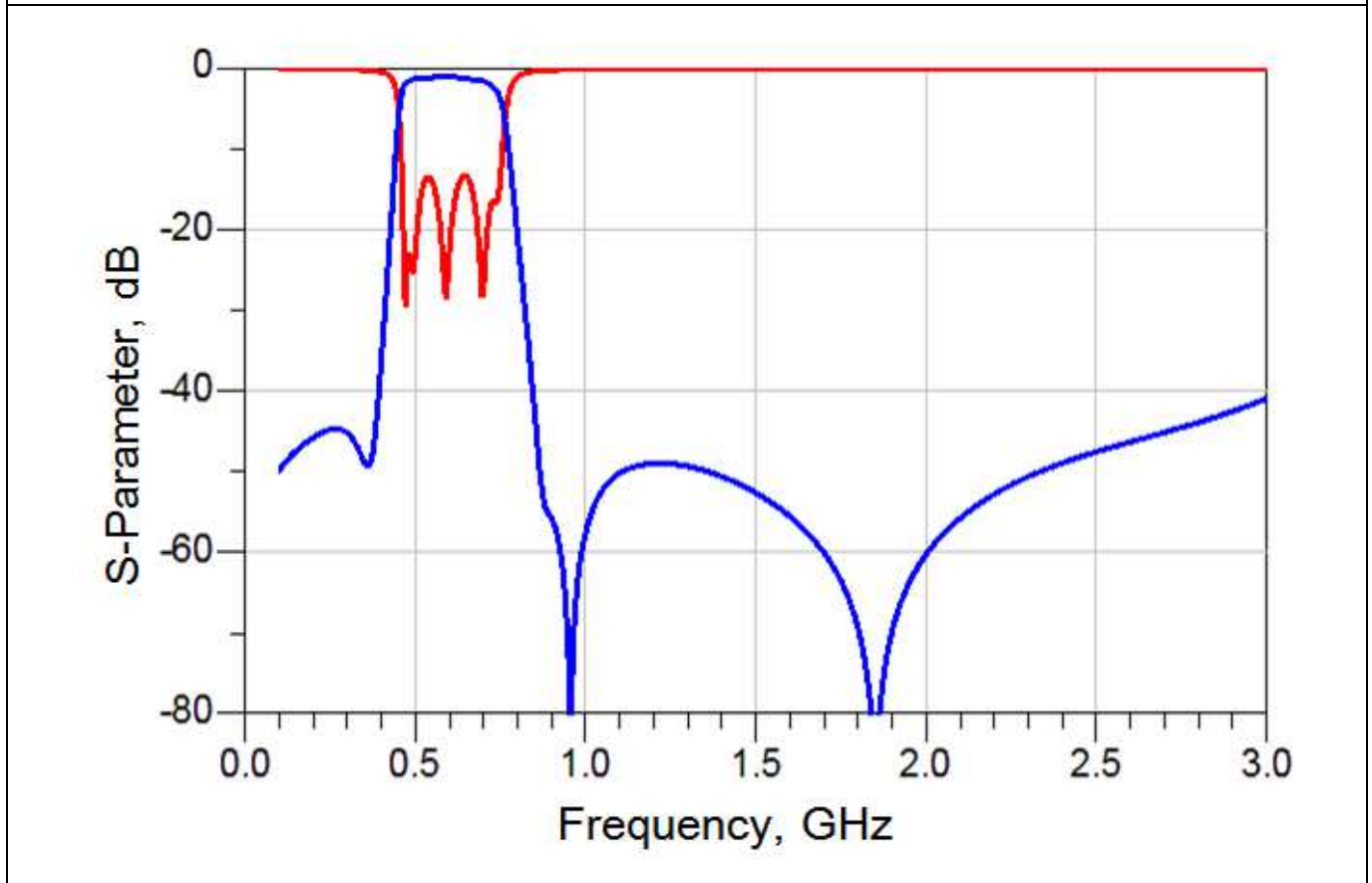
Typical Electrical Chart

SOLDER LAND PATTERN

Figure

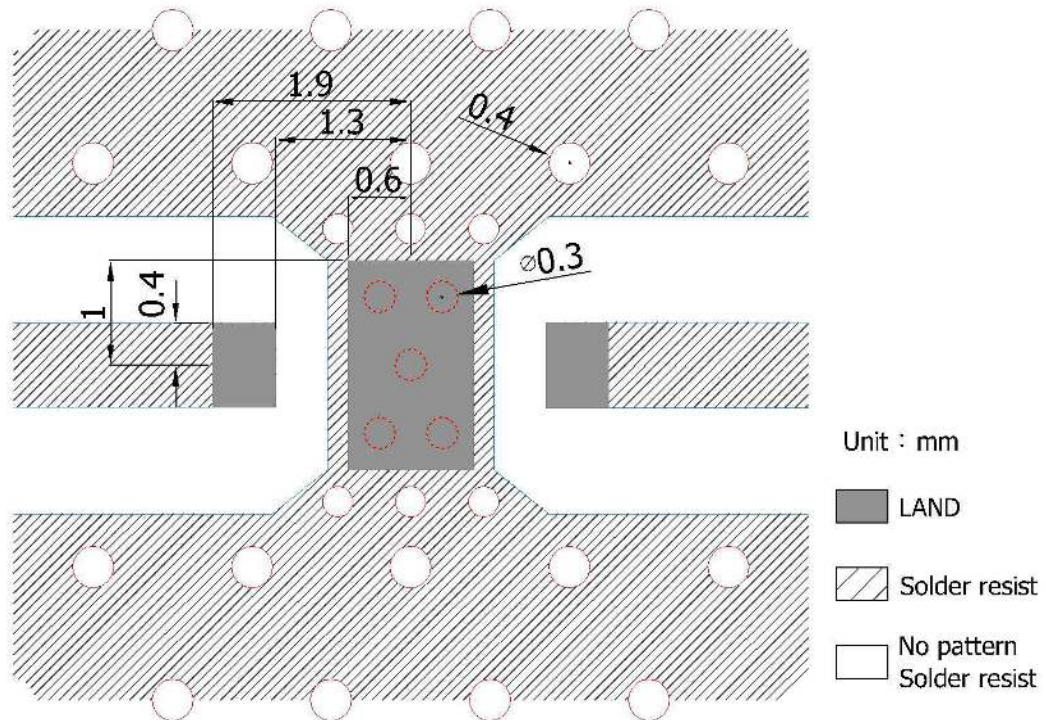

Unit : mm

Line width to be designed to match 75 Ω characteristic impedance, depending on PCB material and thickness.
Both of impedance 50 Ω and 75 Ω are the same land pattern.

Test board

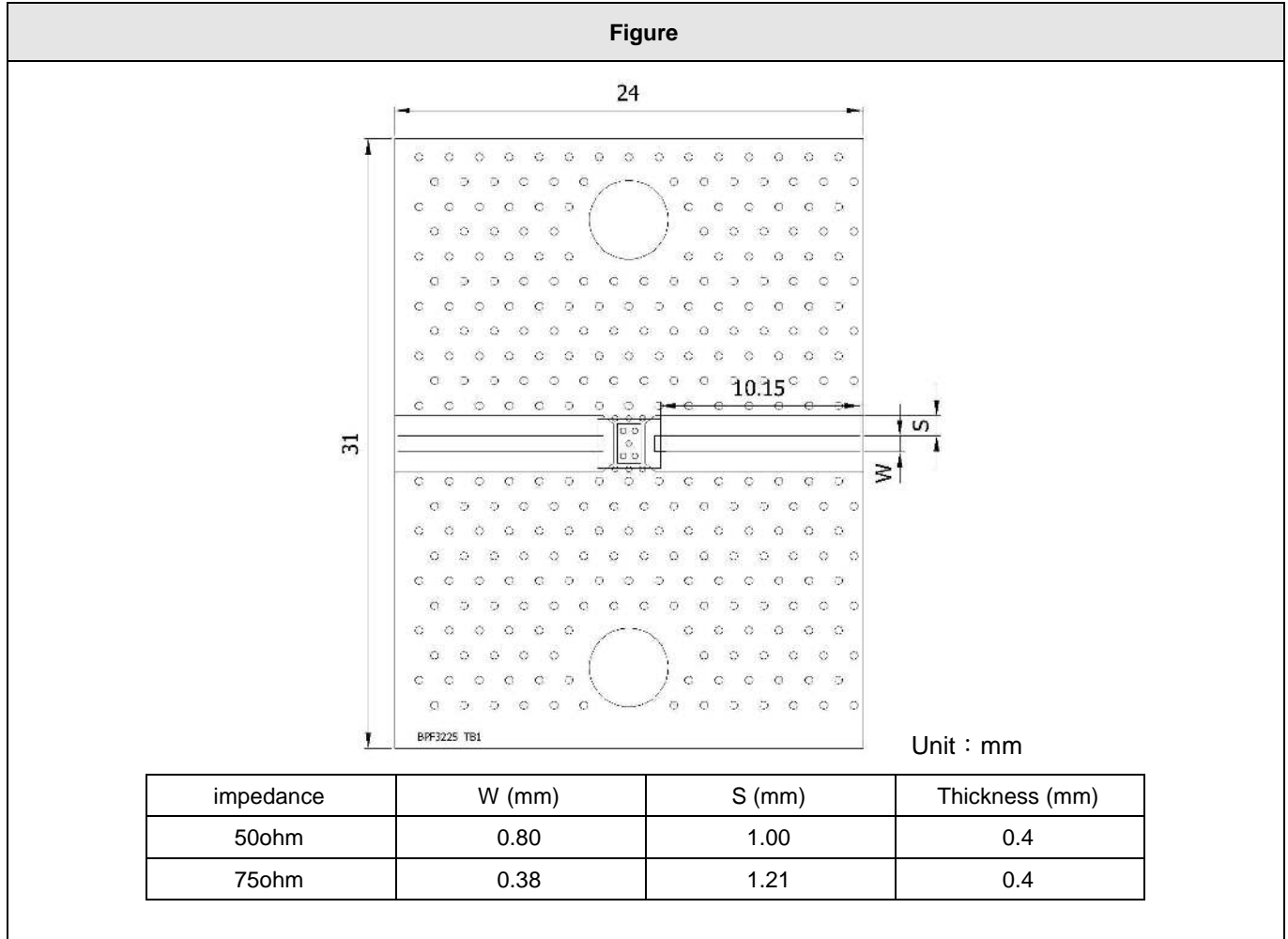

RELIABILITY TEST

Test item	Test condition / Test method	Specification
Solderability JIS C 0050-4.6 JESD22-B102D	*Solder bath temperature : $235 \pm 5^{\circ}\text{C}$ *Immersion time : 2 ± 0.5 sec Solder : Sn3Ag0.5Cu for lead-free	At least 95% of a surface of each terminal electrode must be covered by fresh solder.
Leaching (Resistance to dissolution of metallization) IEC 60068-2-58	*Solder bath temperature : $260 \pm 5^{\circ}\text{C}$ *Leaching immersion time : 30 ± 0.5 sec Solder : SN63A	Loss of metallization on the edges of each electrode shall not exceed 25%.
Resistance to soldering heat JIS C 0050-5.4	*Preheating temperature : $120\sim 150^{\circ}\text{C}$, 1 minute. *Solder temperature : $270\pm 5^{\circ}\text{C}$ *Immersion time : 10 ± 1 sec Solder : Sn3Ag0.5Cu for lead-free Measurement to be made after keeping at room temperature for 24 ± 2 hrs	No mechanical damage. Electrical specification shall satisfy the descriptions in electrical characteristics under the operational temperature range within $-40 \sim 85^{\circ}\text{C}$. Loss of metallization on the edges of each electrode shall not exceed 25%.
Drop Test JIS C 0044 Customer's specification.	*Height : 75 cm *Test Surface : Rigid surface of concrete or steel. *Times : 6 surfaces for each units ; 2 times for each side.	No mechanical damage. Electrical specification shall satisfy the descriptions in electrical characteristics under the operational temperature range within $-40 \sim 85^{\circ}\text{C}$.
Vibration JIS C 0040	*Frequency : 10Hz~55Hz~10Hz(1min) *Total amplitude : 1.5mm *Test times : 6hrs.(Two hrs each in three mutually perpendicular directions)	No mechanical damage. Electrical specification shall satisfy the descriptions in electrical characteristics under the operational temperature range within $-40 \sim 85^{\circ}\text{C}$.
Adhesive Strength of Termination JIS C 0051- 7.4.3	*Pressurizing force : 5N(≤ 0603) ; 10N(>0603) *Test time : 10 ± 1 sec	No remarkable damage or removal of the termination.
Bending test JIS C 0051- 7.4.1	The middle part of substrate shall be pressurized by means of the pressurizing rod at a rate of about 1 mm/s per second until the deflection becomes 1mm/s and then pressure shall be maintained for 5 ± 1 sec. Measurement to be made after keeping at room temperature for 24 ± 2 hours	No mechanical damage. Electrical specification shall satisfy the descriptions in electrical characteristics under the operational temperature range within $-40 \sim 85^{\circ}\text{C}$.

Approval sheet

<p>Temperature cycle JIS C 0025</p>	<p>1. 30±3 minutes at -40°C±3°C, 2. 10~15 minutes at room temperature, 3. 30±3 minutes at +85°C±3°C, 4. 10~15 minutes at room temperature, Total 100 continuous cycles Measurement to be made after keeping at room temperature for 24±2 hrs</p>	<p>No mechanical damage. Electrical specification shall satisfy the descriptions in electrical characteristics under the operational temperature range within -40 ~ 85°C.</p>
<p>High temperature JIS C 0021</p>	<p>*Temperature : 85°C±2°C *Test duration : 1000+24/-0 hours Measurement to be made after keeping at room temperature for 24±2 hrs</p>	<p>No mechanical damage. Electrical specification shall satisfy the descriptions in electrical characteristics under the operational temperature range within -40 ~ 85°C.</p>
<p>Humidity (steady conditions) JIS C 0022</p>	<p>*Humidity : 90% to 95% R.H. *Temperature : 40±2°C *Time : 1000+24/-0 hrs. Measurement to be made after keeping at room temperature for 24±2 hrs ※ 500hrs measuring the first data then 1000hrs data</p>	<p>No mechanical damage. Electrical specification shall satisfy the descriptions in electrical characteristics under the operational temperature range within -40 ~ 85°C.</p>
<p>Low temperature JIS C 0020</p>	<p>*Temperature : -40°C±2°C *Test duration : 1000+24/-0 hours Measurement to be made after keeping at room temperature for 24±2 hrs</p>	<p>No mechanical damage. Electrical specification shall satisfy the descriptions in electrical characteristics under the operational temperature range within -40 ~ 85°C.</p>

SOLDERING CONDITION

Typical examples of soldering processes that provide reliable joints without any damage are given in Fig 2,

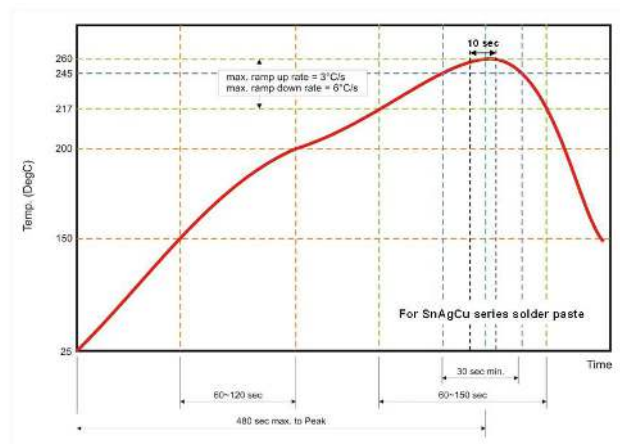

Fig 2. Infrared soldering profile

ORDERING CODE

RF	BPF	322520	0	Y	07B1U
Walsin RF device	Product Code BPF : Band Pass Filter	Dimension code Per 2 digits of Length, Width, Thickness : e.g. : 322520 = Length 32, Width 25, Thickness 20	Unit of dimension 0 : 0.1 mm 1 : 1.0 mm	Application Y: DVB 465- 862MHz/475~675M Hz/703~803MHz	Specification Design code

Minimum Ordering Quantity: 2000 pcs per reel.

PACKAGING

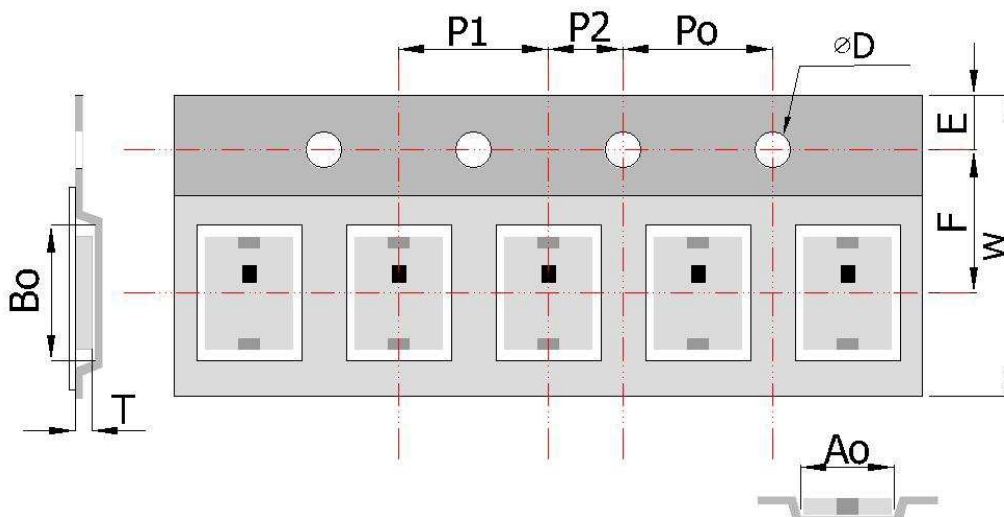

Plastic Tape specifications (unit :mm)

Index	Ao	Bo	ΦD	T	W
Dimension (mm)	2.72 ± 0.10	3.606 ± 0.10	1.55 + 0.10	2.10 ± 0.10	8.0 ± 0.10
Index	E	F	Po	P1	P2
Dimension (mm)	1.75 ± 0.10	3.50 ± 0.05	4.00 ± 0.10	4.00 ± 0.10	2.00 ± 0.10

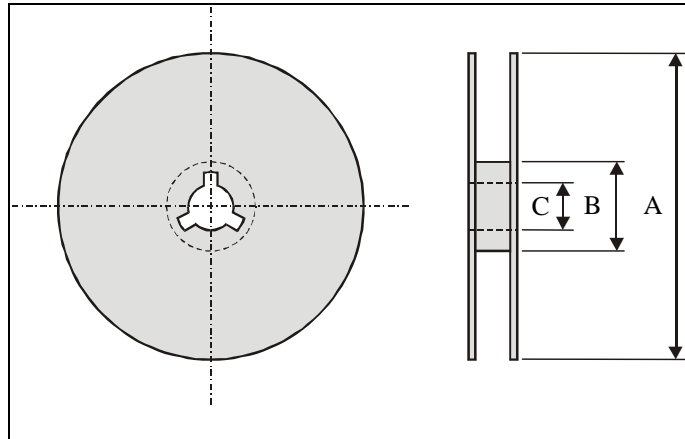
Reel dimensions

Index	A	B	C
Dimension (mm)	Φ178.0	Φ60.0	Φ13.0

Taping Quantity: 2000 pieces per 7" reel

CAUTION OF HANDLING**Limitation of Applications**

Please contact us before using our products for the applications listed below which require especially high reliability for the prevention of defects, which might directly cause damage to the third party's life, body or property.

- (1) Aircraft equipment
- (2) Aerospace equipment
- (3) Undersea equipment
- (4) Medical equipment
- (5) Disaster prevention / crime prevention equipment
- (6) Traffic signal equipment
- (7) Transportation equipment (vehicles, trains, ships, etc.)
- (8) Applications of similar complexity and /or reliability requirements to the applications listed in the above.

Storage condition

- (1) Products should be used in 6 months from the day of WAL SIN outgoing inspection, which can be confirmed.
- (2) Storage environment condition.
 - Products should be storage in the warehouse on the following conditions.
 - Temperature : -10 to +40°C
 - Humidity : 30 to 70% relative humidity
 - Don't keep products in corrosive gases such as sulfur. Chlorine gas or acid or it may cause oxidization of electrode, resulting in poor solderability.
 - Products should be storage on the palette for the prevention of the influence from humidity, dust and son on.
 - Products should be storage in the warehouse without heat shock, vibration, direct sunlight and so on.
 - Products should be storage under the airtight packaged condition.