

UNCONTROLLED DOCUMENT

(LX)	PART NUMBER LDS-A5644RI	REV.
REV.	E.C.N. NUMBER AND REVISION COMMENTS	DATE

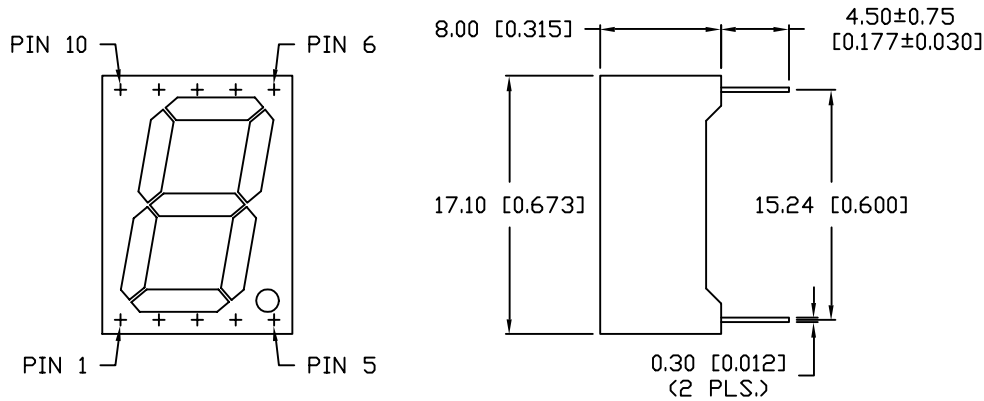

ELECTRO-OPTICAL CHARACTERISTICS $T_A=25^\circ\text{C}$ $I_f=10\text{mA}$

PARAMETER	MIN	TYP	MAX	UNITS	TEST COND
PEAK WAVELENGTH		635 (RED)		nm	
FORWARD VOLTAGE		2.0	2.5	V_f	
REVERSE VOLTAGE	5.0			V_r	$I_r=100\mu\text{A}$
AXIAL INTENSITY		3500		μcd	$I_f=10\text{mA}$
EMITTED COLOR:	RED				
FACE COLOR:	GRAY				
SEGMENT COLOR:	MILKY WHITE DIFFUSED				

LIMITS OF SAFE OPERATION AT 25°C PER CHIP

PARAMETER	MAX	UNITS
PEAK FORWARD CURRENT*	150	mA
STEADY CURRENT	30	mA
POWER DISSIPATION	105	mW
DERATE FROM 25°C	-1.2	mW/°C
OPERATING, STORAGE TEMP.	-40 TO +85	°C
SOLDERING TEMP.	+260	°C
2.0mm FROM BODY		3 SEC. MAX

* $t < 10\mu\text{s}$

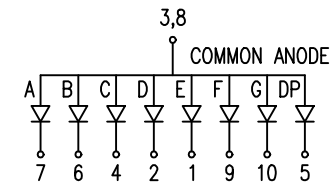
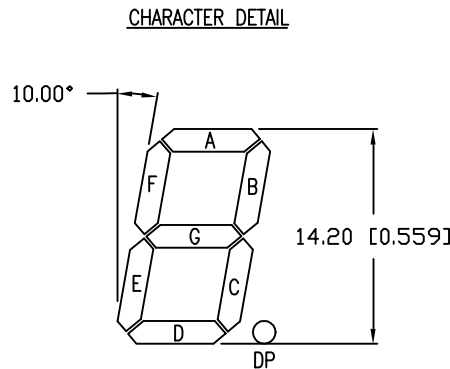
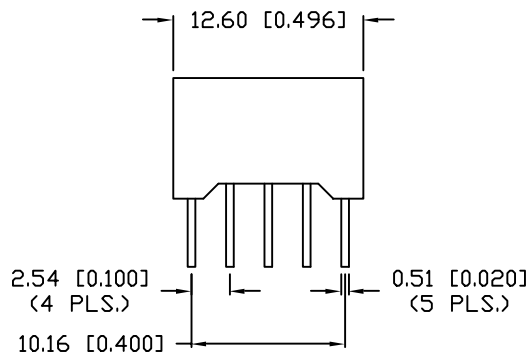

UNCONTROLLED DOCUMENT

*UNLESS OTHERWISE SPECIFIED TOLERANCE IS $\pm 0.25\text{mm}$ ($\pm 0.010''$)

REV.	PART NUMBER LDS-A5644RI	CONFIDENTIAL INFORMATION THE INFORMATION CONTAINED IN THIS DOCUMENT IS THE PROPERTY OF LUMEX INC. EXCEPT AS SPECIFICALLY AUTHORIZED IN WRITING BY LUMEX INC., THE HOLDER OF THIS DOCUMENT SHALL KEEP ALL INFORMATION CONTAINED HEREIN CONFIDENTIAL AND SHALL PROTECT SAME IN WHOLE OR IN PART FROM DISCLOSURE AND DISSEMINATION TO ALL THIRD PARTIES.	LUMEX INCORPORATED 290 E. HELLEN ROAD PALATINE, ILLINOIS 60067 PHONE: 1-847-359-2790 WEB: HTTP://WWW.LUMEX.COM
0.56" SEVEN SEGMENT, SINGLE DIGIT DISPLAY, 635nm RED CHIPS, GRAY FACE WITH WHITE SEGMENTS, COMMON ANODE, RIGHT DECIMAL POINT.		RELIABILITY NOTE OUR MANY YEARS OF EXPERIENCE DATA ACCUMULATION INDICATE THAT SOLDER HEAT IS A MAJOR CAUSE OF EARLY AND FUTURE FAILURE. PLEASE PAY ATTENTION TO YOUR SOLDERING PROCESS.	DRAWN BY: BC CHECKED BY: APPROVED BY: DATE: 4-19-99 PAGE: 1 OF 1 SCALE: N/A