

FRED Pt[®] Gen 5 Ultrafast Rectifier Diode, 1200 V, 120 A

SOT-227

PRIMARY CHARACTERISTICS	
V_R	1200 V
V_F (typical) at 60 A, per diode	1.99 V
t_{rr} (typical) at 60 A, per diode	71 ns
$I_{F(DC)}$ per module at $T_C = 85\text{ }^\circ\text{C}$	120 A
Type	Modules - diode FRED Pt [®]
Package	SOT-227
Circuit configuration	Two separate diodes, parallel pin-out

FEATURES

- Ultrafast and optimized Q_{rr}
- Best in class forward voltage drop and switching losses trade off
- Optimized for high speed operation
- 175 °C maximum operating junction temperature
- Electrically isolated base plate
- Large creepage distance between terminal
- Simplified mechanical designs, rapid assembly
- Designed and qualified for industrial level
- UL approved file E78996
- Material categorization: for definitions of compliance please see www.vishay.com/doc?99912

DESCRIPTION / APPLICATIONS

Featuring a unique combination of low conduction and switching losses, the VS-U5FH120FA120 is the right choice for high frequency converters, both soft switched / resonant. The semiconductor in the SOT-227 package is isolated from the copper base plate, allowing for common heatsinks and compact assemblies to be built.

These modules are specifically designed to improve efficiency of PFC and output rectification stages of EV / HEV battery charging stations, booster stage of solar inverters, and UPS applications, these devices are perfectly matched to operate with MOSFETs or high speed IGBTs.

ABSOLUTE MAXIMUM RATINGS				
PARAMETER	SYMBOL	TEST CONDITIONS	MAX.	UNITS
Cathode to anode voltage	V_R		1200	V
Continuous forward current per diode	I_F	$T_C = 85\text{ }^\circ\text{C}$	60	A
Single pulse forward current per diode	I_{FSM}	$T_J = 25\text{ }^\circ\text{C}$	340	
Maximum power dissipation per module	P_D	$T_C = 85\text{ }^\circ\text{C}$	261	W
RMS isolation voltage	V_{ISOL}	Any terminal to case, $t = 1\text{ min}$	2500	V
Operating junction and storage temperature range	T_J, T_{Stg}		-55 to +175	°C

ELECTRICAL SPECIFICATIONS ($T_J = 25\text{ }^\circ\text{C}$ unless otherwise specified)						
PARAMETER	SYMBOL	TEST CONDITIONS	MIN.	TYP.	MAX.	UNITS
Cathode to anode breakdown voltage	V_{BR}	$I_R = 100\text{ }\mu\text{A}$	1200	-	-	V
Forward voltage	V_{FM}	$I_F = 60\text{ A}$	-	1.99	2.5	
		$I_F = 60\text{ A}, T_J = 150\text{ }^\circ\text{C}$	-	1.74	-	
Reverse leakage current	I_{RM}	$V_R = 1200\text{ V}$	-	0.4	80	μA
		$T_J = 125\text{ }^\circ\text{C}, V_R = 1200\text{ V}$	-	79	-	
		$T_J = 150\text{ }^\circ\text{C}, V_R = 1200\text{ V}$	-	255	-	



DYNAMIC RECOVERY CHARACTERISTICS ($T_J = 25\text{ }^\circ\text{C}$ unless otherwise specified)						
PARAMETER	SYMBOL	TEST CONDITIONS	MIN.	TYP.	MAX.	UNITS
Reverse recovery time	t_{rr}	$T_J = 25\text{ }^\circ\text{C}$	-	71	-	ns
		$T_J = 125\text{ }^\circ\text{C}$	-	114	-	
Peak recovery current	I_{RRM}	$T_J = 25\text{ }^\circ\text{C}$	-	34	-	A
		$T_J = 125\text{ }^\circ\text{C}$	-	53	-	
Reverse recovery charge	Q_{rr}	$T_J = 25\text{ }^\circ\text{C}$	-	2.3	-	μC
		$T_J = 125\text{ }^\circ\text{C}$	-	5.5	-	
Junction capacitance	C_T	$V_R = 1200\text{ V}$	-	22.5	-	pF

THERMAL - MECHANICAL SPECIFICATIONS						
PARAMETER	SYMBOL	TEST CONDITIONS	MIN.	TYP.	MAX.	UNITS
Thermal resistance junction to case, per diode	R_{thJC}		-	-	0.69	$^\circ\text{C/W}$
Thermal resistance junction to case, per module			-	-	0.345	
Thermal resistance case to heatsink, per module	R_{thCS}	Flat, greased surface	-	0.05	-	
Weight			-	30	-	g
Mounting torque		Torque per diode	-	-	1.1 (9.7)	Nm (lb.in)
		Torque to heatsink	-	-	1.8 (15.9)	Nm (lb.in)
Case style			SOT-227			

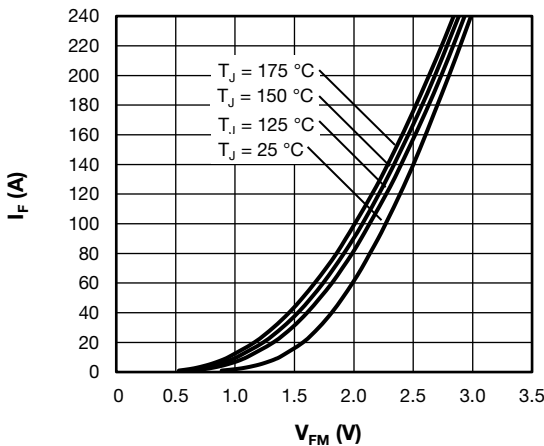

Fig. 1 - Typical Forward Voltage Drop Characteristics

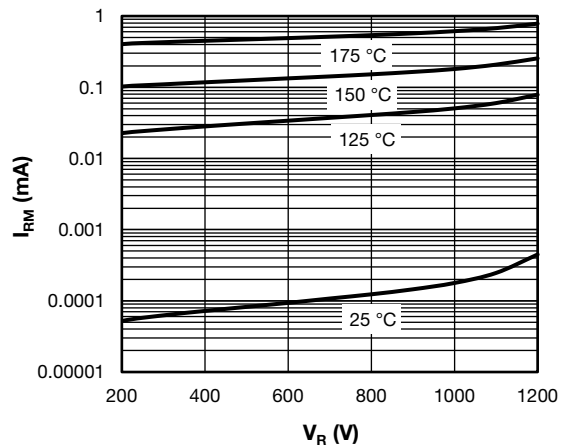

Fig. 2 - Typical Values of Reverse Current

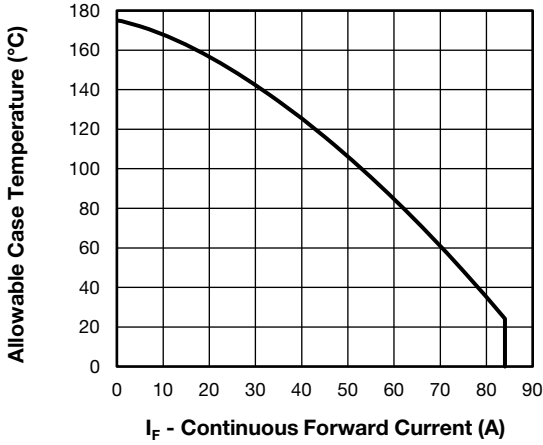

Fig. 3 - Maximum Allowable Case Temperature vs. Average Forward Current (Per Diode)

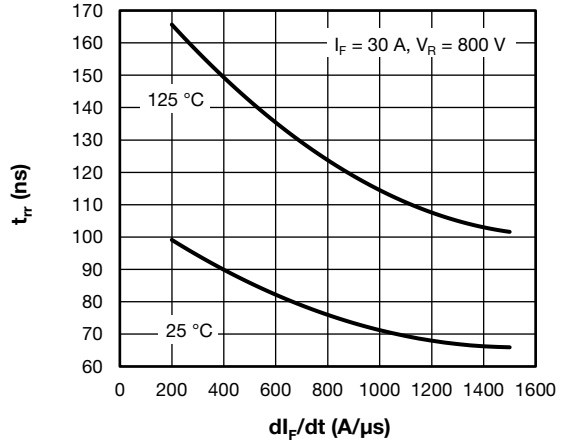

Fig. 6 - Diode Reverse Recovery Time vs. di_F/dt

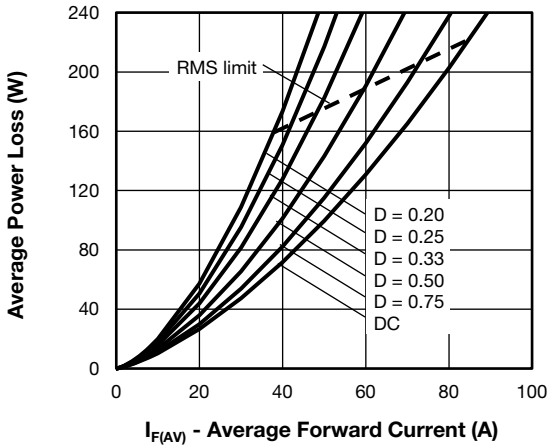

Fig. 4 - Average Power Loss vs. Average Forward Current

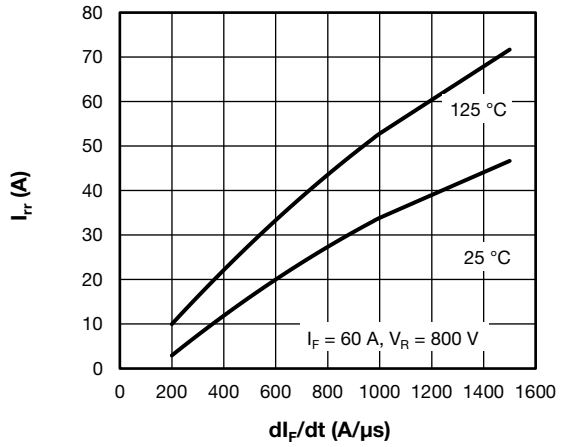

Fig. 7 - Diode Reverse Recovery Current vs. di_F/dt

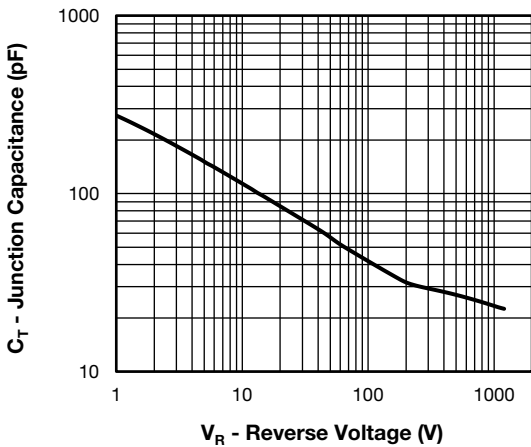

Fig. 5 - Junction Capacitance vs. Reverse Voltage

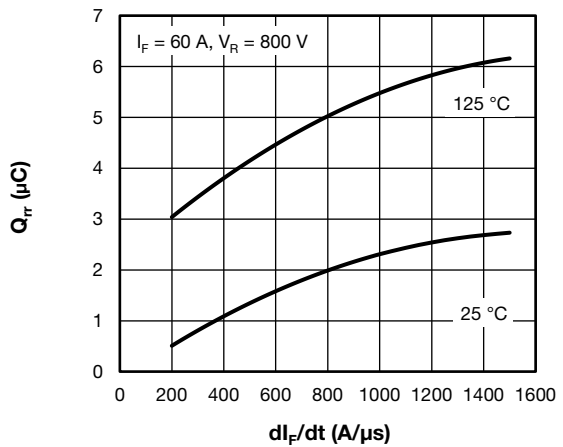

Fig. 8 - Diode Reverse Recovery Charge vs. di_F/dt

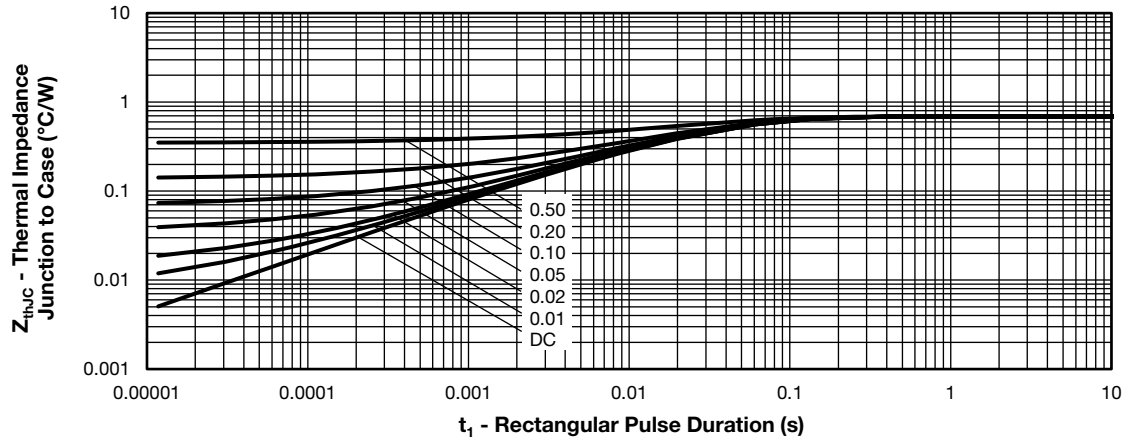

Fig. 9 - Maximum Thermal Impedance Junction to Case

ORDERING INFORMATION TABLE

Device code	VS-	U5F	H	120	F	A	120
	①	②	③	④	⑤	⑥	⑦

- 1** - Vishay Semiconductors product
- 2** - U5F = Gen 5 FRED Pt® family
- 3** - H = Ultrafast FRED Pt® diode
- 4** - Current rating per module (120 = 120 A)
- 5** - F = circuit configuration (two separate diodes, parallel pin-out)
- 6** - Package indicator (SOT-227 standard insulated base)
- 7** - Voltage rating (120 = 1200 V)

CIRCUIT CONFIGURATION		
CIRCUIT	CIRCUIT CONFIGURATION CODE	CIRCUIT DRAWING
Two separate diodes, parallel pin-out	F	

LINKS TO RELATED DOCUMENTS	
Dimensions	www.vishay.com/doc?95423
Packaging information	www.vishay.com/doc?95425



SOT-227 Generation 2

DIMENSIONS in millimeters (inches)

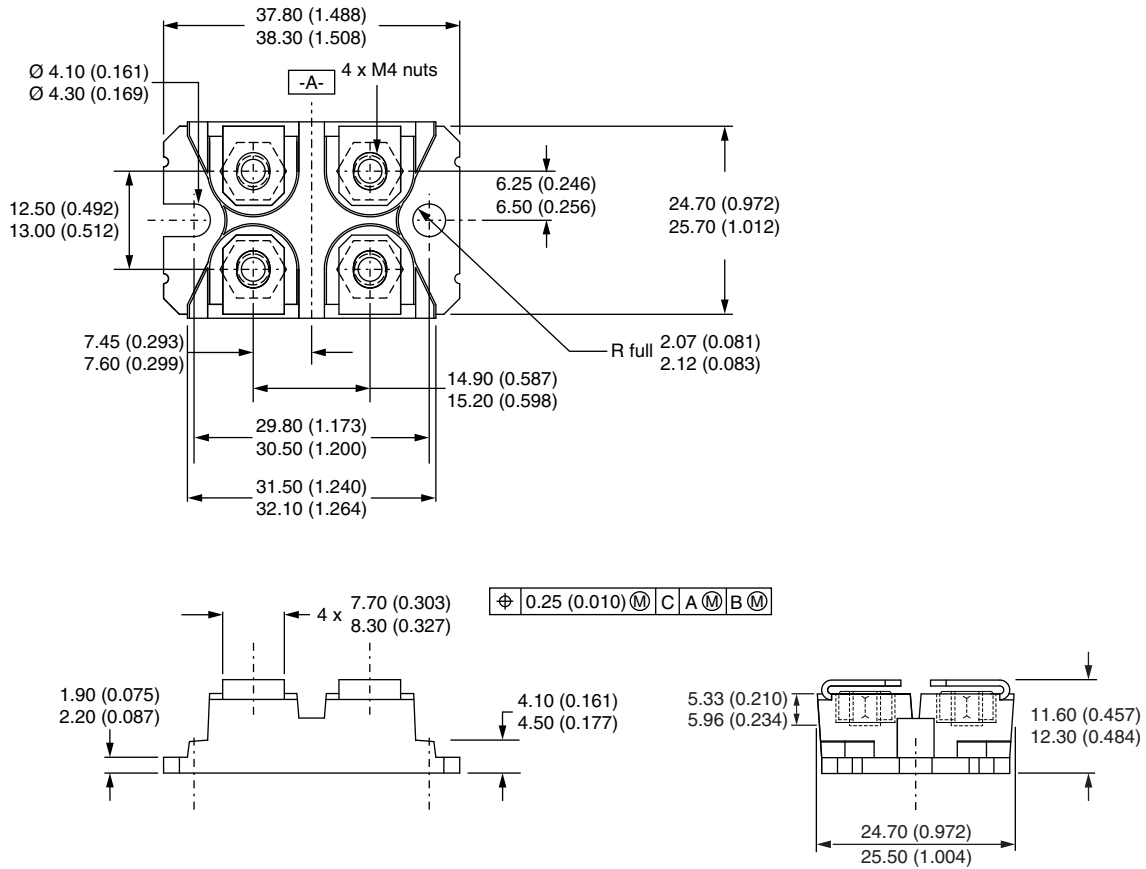

Note

- Controlling dimension: millimeter



Disclaimer

ALL PRODUCT, PRODUCT SPECIFICATIONS AND DATA ARE SUBJECT TO CHANGE WITHOUT NOTICE TO IMPROVE RELIABILITY, FUNCTION OR DESIGN OR OTHERWISE.

Vishay Intertechnology, Inc., its affiliates, agents, and employees, and all persons acting on its or their behalf (collectively, "Vishay"), disclaim any and all liability for any errors, inaccuracies or incompleteness contained in any datasheet or in any other disclosure relating to any product.

Vishay makes no warranty, representation or guarantee regarding the suitability of the products for any particular purpose or the continuing production of any product. To the maximum extent permitted by applicable law, Vishay disclaims (i) any and all liability arising out of the application or use of any product, (ii) any and all liability, including without limitation special, consequential or incidental damages, and (iii) any and all implied warranties, including warranties of fitness for particular purpose, non-infringement and merchantability.

Statements regarding the suitability of products for certain types of applications are based on Vishay's knowledge of typical requirements that are often placed on Vishay products in generic applications. Such statements are not binding statements about the suitability of products for a particular application. It is the customer's responsibility to validate that a particular product with the properties described in the product specification is suitable for use in a particular application. Parameters provided in datasheets and / or specifications may vary in different applications and performance may vary over time. All operating parameters, including typical parameters, must be validated for each customer application by the customer's technical experts. Product specifications do not expand or otherwise modify Vishay's terms and conditions of purchase, including but not limited to the warranty expressed therein.

Hyperlinks included in this datasheet may direct users to third-party websites. These links are provided as a convenience and for informational purposes only. Inclusion of these hyperlinks does not constitute an endorsement or an approval by Vishay of any of the products, services or opinions of the corporation, organization or individual associated with the third-party website. Vishay disclaims any and all liability and bears no responsibility for the accuracy, legality or content of the third-party website or for that of subsequent links.

Except as expressly indicated in writing, Vishay products are not designed for use in medical, life-saving, or life-sustaining applications or for any other application in which the failure of the Vishay product could result in personal injury or death. Customers using or selling Vishay products not expressly indicated for use in such applications do so at their own risk. Please contact authorized Vishay personnel to obtain written terms and conditions regarding products designed for such applications.

No license, express or implied, by estoppel or otherwise, to any intellectual property rights is granted by this document or by any conduct of Vishay. Product names and markings noted herein may be trademarks of their respective owners.