

DESCRIPTION: R/A .370 FOOTPRINT MACHINED FEMALE

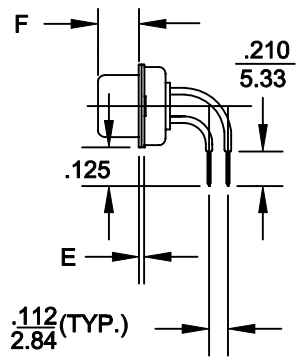

	A	B	C	E	F	G
9	1.213	.984	.494	.030	.243	0.436
	30.81	24.99	12.55	0.76	6.17	11.07
15	1.541	1.312	.494	.030	.243	0.763
	39.14	33.32	12.55	0.76	6.17	19.38
25	2.088	1.852	.494	.030	.243	1.308
	53.04	47.04	12.55	0.76	6.17	33.22
37	2.729	2.500	.494	.030	.243	1.962
	69.32	63.50	12.55	1.76	6.17	49.83
50	2.635	2.406	.605	.030	.243	1.744
	69.32	61.11	15.37	.076	6.17	44.32

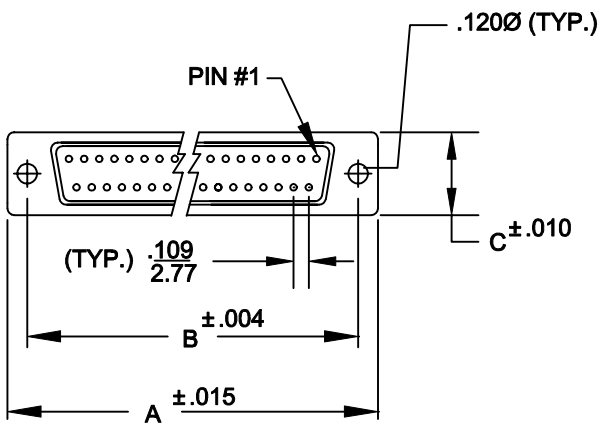
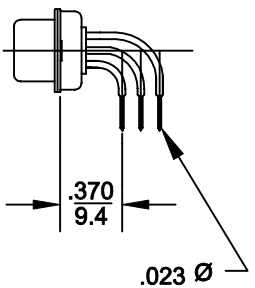
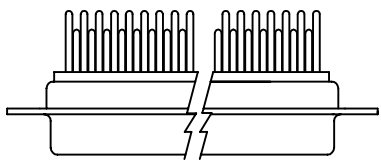
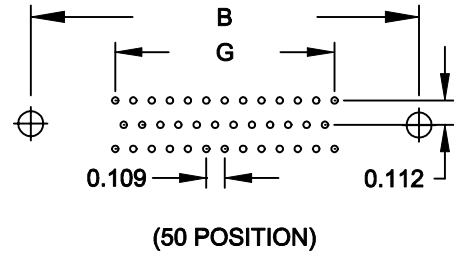
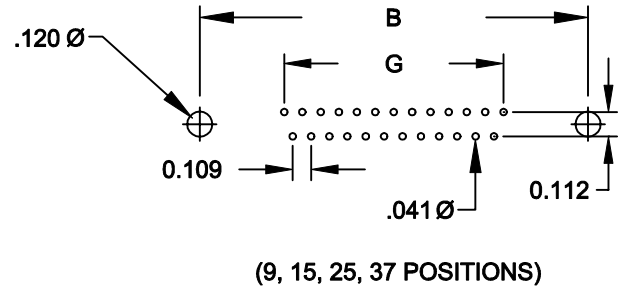

- 174-XXX-21X-XX1
- SERIES _____
 - POSITIONS _____
 - GENDER _____
 - 1 = MALE
 - 2 = FEMALE
 - TERMINATION _____
 - 1 = PC MOUNT
 - SHELL PLATING _____
 - 1 = YELLOW CHROMATE
 - 2 = TIN
 - HARDWARE OPTIONS _____
 - 00 = NO HARDWARE
 - 24 = SHORT BRACKET WITH 4-40 SCREW
 - 14 = SHORT BRACKET WITH 4-40 SCREW LOCK
 - PLATING OPTIONS _____
 - 1 = GOLD FLASH
 - 2 = 30 MICRO-INCH GOLD

SPECIFICATIONS:

MATERIALS:

SHELL: STEEL, YELLOW CHROMATE OR TIN PLATED
 INSULATOR: UL 94V-0 RATED BEIGE PBT
 +30% FIBER-GLASS OR NYLON-66

ELECTRICALS:

CURRENT RATING: 5 AMPS
 CONTACT RESISTANCE: 15 mOHMS MAX
 INSULATOR RESISTANCE: 1000 MOHMS MIN
 VOLTAGE: 500V AC FOR 1 MINUTE
 TEMPERATURE: -50°C TO +100°C

	THESE DRAWINGS AND SPECIFICATIONS ARE THE PROPERTY OF NorComp AND SHALL NOT BE REPRODUCED, COPIED OR USED AS THE BASIS FOR THE MANUFACTURE OF SALE OF APPARATUS WITHOUT WRITTEN PERMISSION.		DRAWN: WAYNE ROBBINS	DATE: 9-01-98
			CHECKED:	DATE:
<h1>NorComp</h1>		SCALE: 1:1	SHEET OF	REV 6
		DWG NO. 174-XXX-21X-001		

DESCRIPTION:

173/174 SERIES

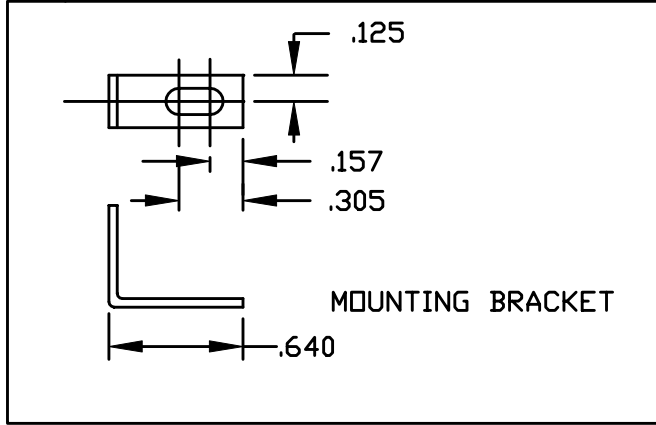

HARDWARE OPTIONS

REPLACE -XX IN LAST 3 DIGITS WITH OPTION CHOSEN

173/174 SERIES

- 14X = SHORT BRACKET & 4-40 FEMALE HEX SOCKET
- 24X = SHORT BRACKET & 4-40 SCREW

175/176 SERIES

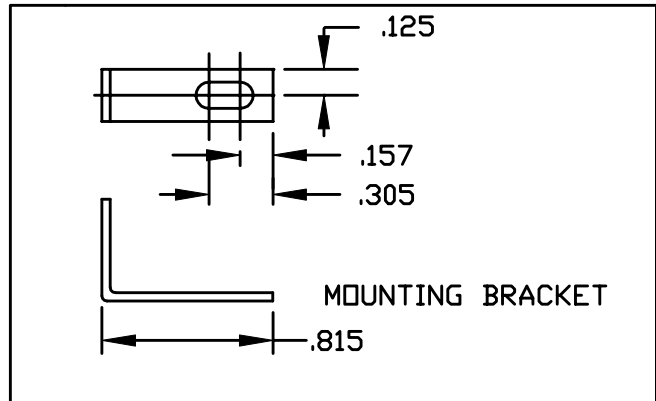

175/176 SERIES

- 15X = LONG BRACKET & 4-40 FEMALE HEX SOCKET
- 25X = LONG BRACKET & 4-40 SCREW

MATERIAL:
COLD ROLLED STEEL

PLATING:
CLEAR ZINC OR YELLOW CHROMATE

	THESE DRAWINGS AND SPECIFICATIONS ARE THE PROPERTY OF NorComp AND SHALL NOT BE REPRODUCED, COPIED OR USED AS THE BASIS FOR THE MANUFACTURE OF SALE OF APPARATUS WITHOUT WRITTEN PERMISSION.		DRAWN: PAM JENKINS	DATE: 2-20-02	
			CHECKED:	DATE:	
<h1>NorComp</h1>			SCALE:	SHEET 1 OF 1	REV 1
			DWG NO. R/A BRACKET OPTIONS FOR MACHINED CONTACTS		