

### 1SMA10CAT3G Series

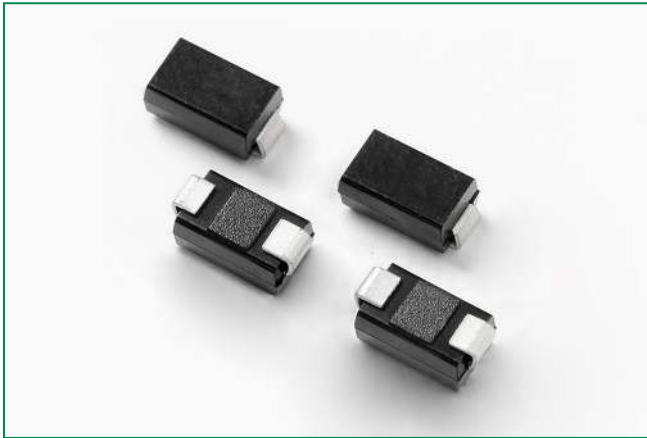

#### Description

The 1SMA10CAT3G series is designed to protect voltage sensitive components from high voltage, high energy transients. They have excellent clamping capability, high surge capability, low zener impedance and fast response time. The 1SMA10CAT3G series is supplied in the Littelfuse exclusive, cost-effective, highly reliable package and is ideally suited for use in communication systems, automotive, numerical controls, process controls, medical equipment, business machines, power supplies and many other industrial/consumer applications.

#### Features

- Working Peak Reverse Voltage Range – 10 V to 78 V
- Standard Zener Breakdown Voltage Range – 11.7 V to 91.3 V
- Peak Power – 400 W @ 1 ms
- ESD Rating of Class 3 (> 16 kV) per Human Body Model
- Response Time is Typically < 1 ns
- Flat Handling Surface for Accurate Placement
- Package Design for Top Slide or Bottom Circuit Board Mounting
- Low Profile Package
- These are Pb-Free Device

#### Maximum Ratings and Thermal Characteristics

Parameter	Symbol	Value	Unit
Peak Power Dissipation (Note 1) @ $T_L = 25^\circ\text{C}$ , Pulse Width = 1 ms	$P_{PK}$	400	W
DC Power Dissipation @ $T_L = 75^\circ\text{C}$ Measured Zero Lead Length (Note 2) Derate Above $75^\circ\text{C}$	$P_D$	1.5 20	W mW/ $^\circ\text{C}$
Thermal Resistance from Junction-to-Lead	R <sub>JL</sub>	50	$^\circ\text{C}/\text{W}$
DC Power Dissipation (Note 3) @ $T_A = 25^\circ\text{C}$ Derate Above $25^\circ\text{C}$	$P_D$	0.5 4.0	W mW/ $^\circ\text{C}$
Thermal Resistance from Junction-to-Ambient	R <sub>0JA</sub>	250	$^\circ\text{C}/\text{W}$
Forward Surge Current (Note 4) @ $T_A = 25^\circ\text{C}$	$I_{FSM}$	40	A
Operating and Storage Temperature Range	$T_J, T_{stg}$	-65 to +150	$^\circ\text{C}$

Stresses exceeding those listed in the Maximum Ratings table may damage the device. If any of these limits are exceeded, device functionality should not be assumed, damage may occur and reliability may be affected.

1. 10 X 1000  $\mu\text{s}$ , non-repetitive.
2. 1" square copper pad, FR-4 board.
3. FR-4 board, using Littelfuse minimum recommended footprint, as shown in 403D-02 case outline dimensions spec.

#### Functional Diagram

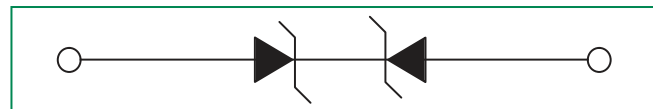

#### Additional Information



Datasheet



Resources



Samples

**I-V Curve Characteristics** ( $T_A = 25^\circ\text{C}$  unless otherwise noted)

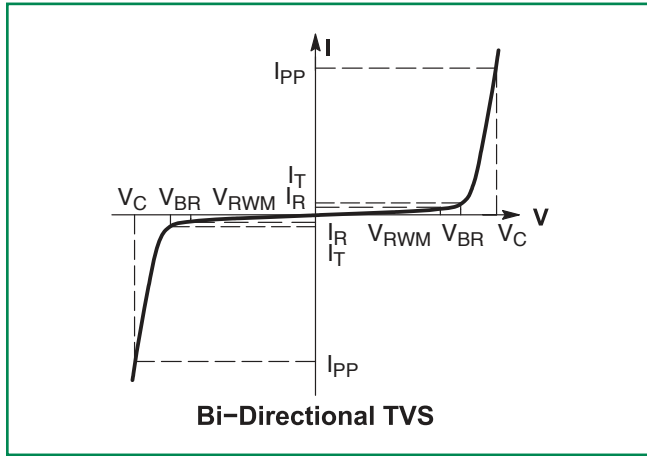

Symbol	Parameter
$I_{PP}$	Maximum Reverse Peak Pulse Current
$V_C$	Clamping Voltage @ $I_{PP}$
$V_{RWM}$	Working Peak Reverse Voltage
$I_R$	Maximum Reverse Leakage Current @ $V_{RWM}$
$V_{BR}$	Breakdown Voltage @ $I_T$
$I_T$	Test Current

### Electrical Characteristics

Device*	Device Marking	V <sub>RWM</sub> (Note 6)	I <sub>R</sub> @ V <sub>RWM</sub>	Breakdown Voltage				V <sub>C</sub> @ I <sub>PP</sub> (Note 8)		C Typ. (Note 9)
				V <sub>BR</sub> @ I <sub>T</sub> (V) (Note 7)			@ I <sub>T</sub>	V <sub>C</sub>	I <sub>PP</sub>	
				MIN	NOM	MAX	mA	Volts	Amps	
1SMA10CAT3G	QXC	10	2.5	11.1	11.69	12.27	1.0	17.0	23.5	580
1SMA12CAT3G	REC	12	2.5	13.3	14.00	14.70	1.0	19.9	20.1	490
1SMA13CAT3G	RGC	13	2.5	14.4	15.16	15.92	1.0	21.5	18.6	455
1SMA15CAT3G	RMC	15	2.5	16.7	17.58	18.46	1.0	24.4	16.4	400
1SMA16CAT3G	RPC	16	2.5	17.8	18.74	19.67	1.0	26.0	15.4	375
1SMA18CAT3G	RTC	18	2.5	20	21.06	22.11	1.0	29.2	13.7	335
1SMA20CAT3G	RVC	20	2.5	22.2	23.37	24.54	1.0	32.4	12.3	305
1SMA24CAT3G	RZC	24	2.5	26.7	28.11	29.51	1.0	38.9	10.3	260
1SMA26CAT3G	SEC	26	2.5	28.9	30.42	31.94	1.0	42.1	9.5	240
1SMA28CAT3G	SGC	28	2.5	31.1	32.74	34.37	1.0	45.4	8.8	225
1SMA30CAT3G	SKC	30	2.5	33.3	35.06	36.81	1.0	48.4	8.3	210
1SMA33CAT3G	SMC	33	2.5	36.7	38.63	40.56	1.0	53.3	7.5	190
1SMA36CAT3G	SPC	36	2.5	40	42.11	44.21	1.0	58.1	6.9	175
1SMA40CAT3G	SRC	40	2.5	44.4	46.74	49.07	1.0	64.5	6.2	160
1SMA48CAT3G	SXC	48	2.5	53.3	56.11	58.91	1.0	77.4	5.2	135
1SMA58CAT3G	TGC	58	2.5	64.4	67.79	71.18	1.0	93.6	4.3	115
1SMA60CAT3G	TKC	60	2.5	66.7	70.21	73.72	1.0	96.8	4.1	110
1SMA70CAT3G	TPC	70	2.5	77.8	81.90	85.99	1.0	113	3.5	95
1SMA78CAT3G	TTC	78	2.5	86.7	91.27	95.83	1.0	126	3.2	90
1SMA28AT3G	SG	28	2.5	31.1	32.75	34.4	1	45.4	8.8	430
1SMA30AT3G	SK	30	2.5	33.3	35.05	36.8	1	48.4	8.3	405
1SMA33AT3G	SM	33	2.5	36.7	38.65	40.6	1	53.3	7.5	375
1SMA36AT3G	SP	36	2.5	40	42.1	44.2	1	58.1	6.9	345
1SMA40AT3G	SR	40	2.5	44.4	46.75	49.1	1	64.5	6.2	315
1SMA43AT3G	ST	43	2.5	47.8	50.3	52.8	1	69.4	5.8	295
1SMA45AT3G	SV	45	2.5	50	52.65	55.3	1	72.2	5.5	280
1SMA48AT3G	SX	48	2.5	53.3	56.1	58.9	1	77.4	5.2	265
1SMA54AT3G	TE	54	2.5	60	63.15	66.3	1	87.1	4.6	240
1SMA58AT3G	TG	58	2.5	64.4	67.8	71.5	1	93.6	4.3	225
1SMA70AT3G	TP	70	2.5	77.8	81.9	86.0	1	113	3.5	190
1SMA78AT3G	TTC	78	2.5	86.7	91.27	95.83	1.0	126	3.2	90

4. A transient suppressor is normally selected according to the working peak reverse voltage (V<sub>RWM</sub>), which should be equal to or greater than the DC or continuous peak operating voltage level

5. V<sub>BR</sub> measured at pulse test current I<sub>T</sub> at an ambient temperature of 25°C

6. Surge current waveform per Figure 2 and derate per Figure 3

7. Bias voltage = 0 V, F = 1.0 MHz, T<sub>J</sub> = 25°C.

†Please see 1SMA5.0AT3 to 1SMA7.8AT3 for Unidirectional devices.

**Ratings and Characteristic Curves**

**Figure 1. Pulse Rating Curve**

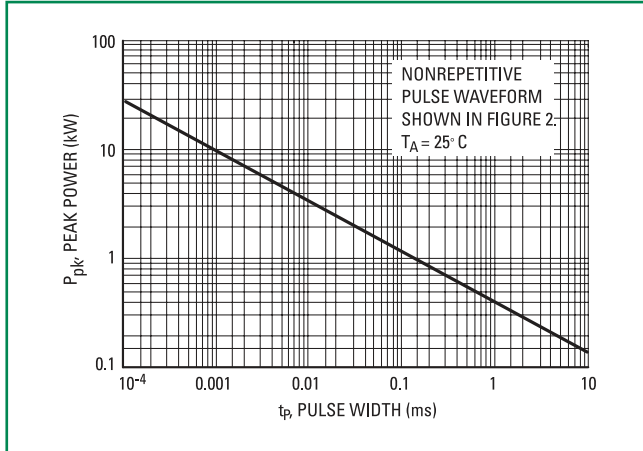

**Figure 2. Pulse Waveform**

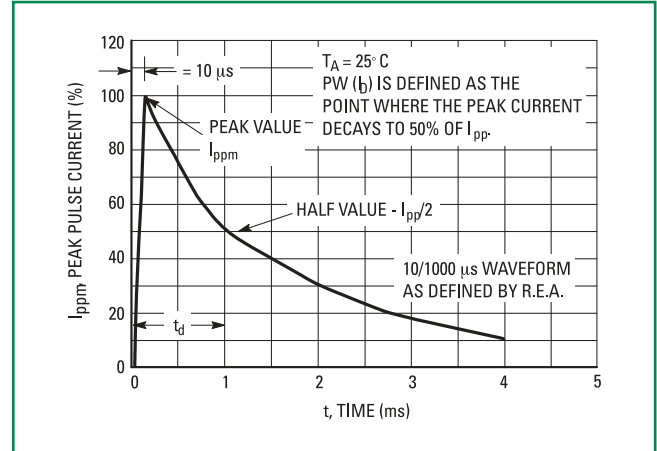

**Figure 3 - Pulse Derating Curve**

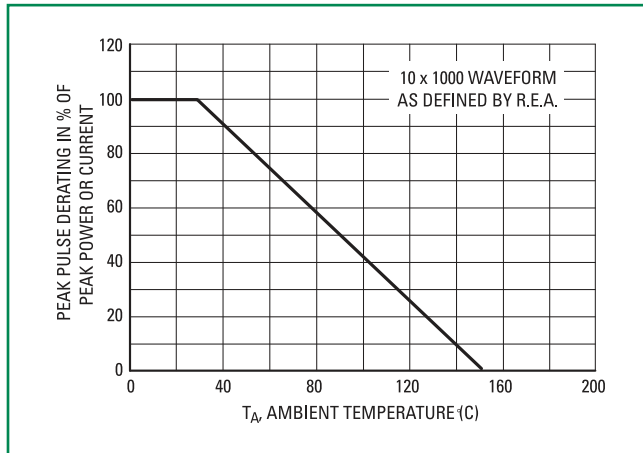

**Figure 4. Typical Junction Capacitance vs. Bias Voltage**

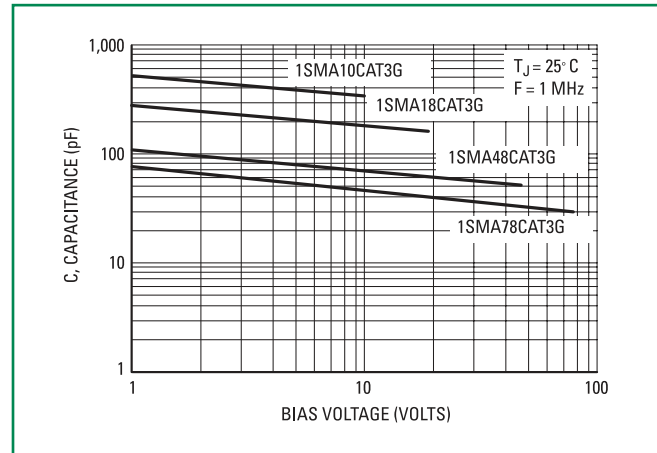

**Dimensions**

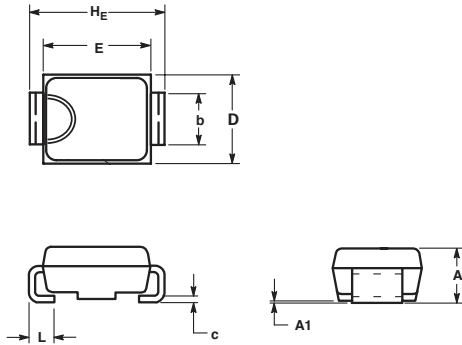

Dim	Inches			Millimeters		
	Min	Nom	Max	Min	Nom	Max
A	0.078	0.083	0.087	1.97	2.10	2.20
A1	0.002	0.004	0.008	0.05	0.10	0.20
b	0.050	0.057	0.064	1.27	1.45	1.63
c	0.006	0.011	0.016	0.15	0.28	0.41
D	0.090	0.103	0.115	2.29	2.60	2.92
E	0.160	0.170	0.180	4.06	4.32	4.57
HE	0.190	0.205	0.220	4.83	5.21	5.59
L	0.030	0.045	0.060	0.76	1.14	1.52

NOTES:

1. DIMENSIONING AND TOLERANCING PER ANSI Y14.5M, 1982.
2. CONTROLLING DIMENSION: INCH.
3. DIMENSION b SHALL BE MEASURED WITHIN DIMENSION L.

STYLE 1:

1. PIN 1. CATHODE (POLARITY BAND)
2. ANODE

**Part Marking System**



- xxC= Device Code (Refer to page 3)
- A= Assembly Location
- Y= Year
- WW = Work Week
- = Pb-Free Package

**Soldering Footprint**

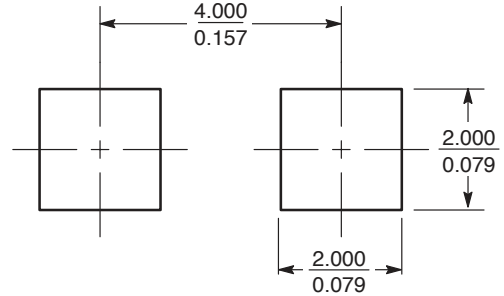

SCALE 8:1 (mm/inches)

**ORDERING INFORMATION**

Device**	Package	Shipping†
1SMAxxAT3G	SMA (Pb-Free)	5,000 / Tape & Reel

\*\*The "T3" suffix refers to a 13 inch reel.

**Flow/Wave Soldering (Solder Dipping)**

Peak Temperature :	260°C
Dipping Time :	10 seconds

**Physical Specifications**

Case	Void-free, transfer-molded, thermosetting plastic
Polarity	Cathode indicated by molded polarity notch
Mounting Position	Any
Finish	All external surfaces are corrosion resistant and leads are readily solderable

**Disclaimer Notice** - Information furnished is believed to be accurate and reliable. However, users should independently evaluate the suitability of and test each product selected for their own applications. Littelfuse products are not designed for, and may not be used in, all applications. Read complete Disclaimer Notice at: [www.littelfuse.com/disclaimer-electronics](http://www.littelfuse.com/disclaimer-electronics).