

GlobTek, Inc. www.globtek.com 186 Veterans Drive, Northvale, NJ 07647 Tel. (201) 784-1000 Fax (201) 784-0111	Drawing Title: GTM91128LI3CEL, ICT / ITE / Medical Power Supply, Efficiency Level: N/A, Case Color/Style: GlobTek Black, Wall Plug-in+Desktop Combination, Li-Ion Battery Charger, Input Rating: 100-240V~, 50-60 Hz, IEC 60320/C8 w/ Wall Blades Option , Output Rating: 12.6W, 12.6V@1.0A, Output Configuration: 1830 mm, 18/1C + Shield Cond, UL 1185, 3 Pin DC Jack, Ferrite: Core Size: 14.2*28.5*8.2, GlobTek Black, GT Cord # C9581, Pin Out: Pin 1:White(+), Pin 2: N/C, Pin 3:Shield(-), Blades/Input Cord: (Order Separately), Approvals: CB 60950; ETL; EAC; SIQ 61558; SIQ; SIQ; SIQ; S-Mark 60950; cRUus (up to 30V); cRUus; S-Mark IEC/EN 60601-1; S-Mark 62368; UKCA; CE; RoHS; China RoHS; WEEE; PSE; Ukraine; Double Insulation; ETL; CB 60335; Book 60601; VCCI; IP54;	
	Model No. GTM91128LI3CEL	
	Part No./Ordering No. GTM91128LI3C1000XF9	Rev C

In Addition to GlobTek Inc.'s renewed ISO9001:2015 - Quality Management System Certification, GlobTek Inc. is now certified to:

ISO13485:2016 - Medical Devices Quality Management System Certification
ISO14001:2015 - Environmental Management System Certification

ISO Certificates are available online at <https://www.globtek.com/iso-certificates/>

The acceptance of this specification and use of the product described in this document indicates the acceptance and binding of the customer to Globtek TERMS AND CONDITIONS (attached to the end of this document), which supersede all other agreements, terms, and conditions (<https://en.globtek.com/terms-and-conditions/>).

The purchaser of this product (Customer) agrees that it is their sole responsibility to determine suitability/fitness of the product described in this specification for their application and to take precautions for protection against any hazards attendant to the handling and use of the product.

Footnote:

GlobTek Inc. will not be liable for the safety and performance of these power supplies/battery packs if unauthorized access and repair occurs. End user should consult applicable UL, CSA or EN standards for proper installation instruction.

Limitation of Use:

GlobTek products are intended for use with commercial, medical, and/or industrial equipment only. GlobTek product are not authorized for use as mission critical components in life support hazardous environment, nuclear or aircraft applications without prior written approval from the CEO of GlobTek Inc.

Contents of this document are subject to change without prior notice.

Customer Approval of Specification:

Please approve, sign and send back to GlobTek so we can complete order processing.
A delay in receipt of this form will delay delivery schedule.

Company Name: _____	Customer P/N: _____
Quote Number: _____	Date: _____
Authorized Representative Name: _____	Authorized Representative Signature: _____

GlobTek, Inc. www.globtek.com 186 Veterans Drive, Northvale, NJ 07647 Tel. (201) 784-1000 Fax (201) 784-0111	Drawing Title: GTM91128LI3CEL, ICT / ITE / Medical Power Supply, Efficiency Level: N/A, Case Color/Style: GlobTek Black, Wall Plug-in+Desktop Combination, Li-Ion Battery Charger, Input Rating: 100-240V~, 50-60 Hz, IEC 60320/C8 w/ Wall Blades Option , Output Rating: 12.6W, 12.6V@1.0A, Output Configuration: 1830 mm, 18/1C + Shield Cond, UL 1185, 3 Pin DC Jack, Ferrite: Core Size: 14.2*28.5*8.2, GlobTek Black, GT Cord # C9581, Pin Out: Pin 1:White(+), Pin 2: N/C, Pin 3:Shield(-), Blades/Input Cord: (Order Separately), Approvals: CB 60950; ETL; EAC; SIQ 61558; SIQ; SIQ; SIQ; S-Mark 60950; cRUus (up to 30V); cRUus; S-Mark IEC/EN 60601-1; S-Mark 62368; UKCA; CE; RoHS; China RoHS; WEEE; PSE; Ukraine; Double Insulation; ETL; CB 60335; Book 60601; VCCI; IP54;	
	Model No. GTM91128LI3CEL	
	Part No./Ordering No. GTM91128LI3C1000XF9	Rev C

REVISION HISTORY

REV	DESCRIPTION	SUB	DATE	APPROVED
C	Add drawing to O/P cord FX9-3/C9581and update pinout description	QA	11/25/2020	QA
B	Update to SF format; revise gift box from 142*60*62mm to 160*67*70mm; revise master carton from 442*330*275mm to 510*430*270mm	bsiep	07/15/2019	QA

POWER SUPPLY INFORMATION

TYPE	Wall Plug-in+Desktop Combination
TECHNOLOGY	Li-Ion Battery Charger
CASE COLOR	GlobTek Black
NAMEPLATE RATED INPUT	100-240V~, 50-60 Hz, 1.5A
INPUT CONFIG	IEC 60320/C8 w/ Wall Blades Option
WATTS	12.60
VOLTS OUT	12.6
CURRENT OUT (Amps)	1.0
BLADE/CORD INCLUDED	None (Order Separately)
BLADE/CORD INSTALLED	None :(Order Separately)
INGRESS PROTECTION	Indoor Use
GROUNDING CONFIGURATION	(F1) Class II / Double Insulated
EFFICIENCY LEVEL	N/A
OUTPUT CONFIGURATION	1830 mm, 18/1C + Shield Cond, UL 1185, 3 Pin DC Jack, Ferrite: Core Size: 14.2*28.5*8.2, GlobTek Black, GT Cord # C9581
OVERMOLDED	Yes
OUTPUT CONNECTOR GENDER	Female
CONNECTOR PIN OUT	Pin 1:White(+), Pin 2: N/C, Pin 3:Shield(-)
LABEL SPECS	GTM91128LIXCEL label,L-1555
SPECIAL BARCODE LABEL MATERIAL	No
PACK SPEC	Standard WPI, Individually Box, User manual DT
USER MANUAL	809-DESKTOPUSERMANUAL on A4 paper

PROPRIETARY INFORMATION

PROPRIETARY OF GLOBTEK, INC. ANY REPRODUCTION, DISCLOSURE OR USE OF THIS DRAWING, IN WHOLE OR IN PART, IS HEREBY PROHIBITED EXCEPT AS SPECIFIED IN WRITING BY GLOBTEK, INC. © GlobTek, Inc. 2012 - 2023

GlobTek, Inc. www.globtek.com 186 Veterans Drive, Northvale, NJ 07647 Tel. (201) 784-1000 Fax (201) 784-0111	Drawing Title: GTM91128LI3CEL, ICT / ITE / Medical Power Supply, Efficiency Level: N/A, Case Color/Style: GlobTek Black, Wall Plug-in+Desktop Combination, Li-Ion Battery Charger, Input Rating: 100-240V~, 50-60 Hz, IEC 60320/C8 w/ Wall Blades Option , Output Rating: 12.6W, 12.6V@1.0A, Output Configuration: 1830 mm, 18/1C + Shield Cond, UL 1185, 3 Pin DC Jack, Ferrite: Core Size: 14.2*28.5*8.2, GlobTek Black, GT Cord # C9581, Pin Out: Pin 1:White(+), Pin 2: N/C, Pin 3:Shield(-), Blades/Input Cord: (Order Separately), Approvals: CB 60950; ETL; EAC; SIQ 61558; SIQ; SIQ; SIQ; S-Mark 60950; cRUus (up to 30V); cRUus; S-Mark IEC/EN 60601-1; S-Mark 62368; UKCA; CE; RoHS; China RoHS; WEEE; PSE; Ukraine; Double Insulation; ETL; CB 60335; Book 60601; VCCI; IP54;	
	Model No. GTM91128LI3CEL	
	Part No./Ordering No. GTM91128LI3C1000XFX9	Rev C

Notes/Modifications/Customizations (notes in this section supersede the values shown in the standard spec)

DIMENSIONS ARE IN MM UNLESS SPECIFIED OTHERWISE

GlobTek, Inc. www.globtek.com 186 Veterans Drive, Northvale, NJ 07647 Tel. (201) 784-1000 Fax (201) 784-0111	Drawing Title: GTM91128LI3CEL, ICT / ITE / Medical Power Supply, Efficiency Level: N/A, Case Color/Style: GlobTek Black, Wall Plug-in+Desktop Combination, Li-Ion Battery Charger, Input Rating: 100-240V~, 50-60 Hz, IEC 60320/C8 w/ Wall Blades Option , Output Rating: 12.6W, 12.6V@1.0A, Output Configuration: 1830 mm, 18/1C + Shield Cond, UL 1185, 3 Pin DC Jack, Ferrite: Core Size: 14.2*28.5*8.2, GlobTek Black, GT Cord # C9581, Pin Out: Pin 1:White(+), Pin 2: N/C, Pin 3:Shield(-), Blades/Input Cord: (Order Separately), Approvals: CB 60950; ETL; EAC; SIQ 61558; SIQ; SIQ; SIQ; S-Mark 60950; cRUus (up to 30V); cRUus; S-Mark IEC/EN 60601-1; S-Mark 62368; UKCA; CE; RoHS; China RoHS; WEEE; PSE; Ukraine; Double Insulation; ETL; CB 60335; Book 60601; VCCI; IP54;	
	Model No. GTM91128LI3CEL	
	Part No./Ordering No. GTM91128LI3C1000XF9	Rev C

ELECTRICAL SPECIFICATIONS

A) ELECTRICAL SPECIFICATIONS

Input Voltage: Specified 90-264 Vac, Nameplate rated: 100-240Vac

Input Frequency: Specified 47-63 Hz, Nameplate rated 50-60Hz

Input Current: < 1.5A RMS Max

01. Pre-Charge Current: 10% of bulk charge current (typical)

02. Bulk Charge Current: see table for nominal value, $\pm 10\%$ max variance

03. Full Charge Voltage: 1 cell: 4.2Vdc; 2 cell: 8.4Vdc, 3 cell: 12.6Vdc, +/-1% Max Variance

04. Charge Termination Current: 10% of bulk charge current (typical)

05. Pre-Charge to Bulk Charge Battery Transition Voltage: 1 cell: 2.86Vdc to 3.15Vdc, 2 cell: 5.72Vdc to 6.30Vdc; 3 cell: 8.58Vdc to 9.45Vdc Charger will be in pre-charge mode when the battery voltage is below the transition voltage.

06. Battery Charging Ambient Temperature: 0°C to 35°C

07. Back-Up Charge Termination Timer: 3 hours standard. Timer may be set to 3 to 12 hours range for batteries with high Ahr capacity by GT engineering. Charger will terminate charging when timer expired. Please advise Sales dept of you battery Ahr capacity.

08. LED Charge Status Indicator

a. Pre-Charge: Solid Amber

b. Bulk Charge: Solid Amber

c. Charge Complete: Solid Green

d. No battery or Fault: Green and Amber LED off

B) ENERGY EFFICIENCY PERFORMANCE

01. CEC Compliant, to Battery Charger Requirements, with up to 10Ahr battery

02. DOE Compliant, to Battery Charger Requirements, with up to 10Ahr battery

C) PROTECTION MODES*

01. Over Voltage Protection: 1 cell: 4.6Vdc - 5.0Vdc, 2 cell: 9.2Vdc - 10.0Vdc; 3 cell: 13.8Vdc - 15.0Vdc Charger will terminate charging when over voltage occurs

02. Short Circuit Protection: Charger will not commence charging when BAT+ and BAT- are shorted

03. Over Temperature Protection: Charger will terminate charging if battery temperature reached $45^{\circ}\text{C} \pm 3^{\circ}\text{C}$. Charger will autorecover when temperature drops to about $30^{\circ}\text{C} \pm 3^{\circ}\text{C}$. For this feature, 10Kohm thermistor (NTC, 103AT) is required to be installed inside the battery pack. For battery packs without the thermistor, over temperature protection feature is not available and a 10K Ohm resistor is installed inside the charger to bypass the over temperature protection circuit.

04. Reverse Battery Protection: Battery should be mechanically protected from being installed reversed

05. Defective Battery Protection: If battery voltage will not rise above the pre-charge to bulk charge transition voltage (2.86Vdc to 3.15Vdc) within 30 minutes from the time pre-charging begins, the battery is considered defective and the charger will terminate charging.

*When fault condition occurs, the battery has to be removed from the charger and reinstalled after at least 3 seconds to reset the protection. Charging will commence after battery reinstallation only when the fault is cleared.

D) SAFETY

1. IEC 60950-1, IEC 60601-1, IEC 60335-1, IEC 61558-1.

2. Dielectric Withstand Voltage: 5656 Vdc from primary to secondary

PROPRIETARY INFORMATION

PROPRIETARY OF GLOBTEK, INC. ANY REPRODUCTION, DISCLOSURE OR USE OF THIS DRAWING, IN WHOLE OR IN PART, IS HEREBY PROHIBITED EXCEPT AS SPECIFIED IN WRITING BY GLOBTEK, INC. © GlobTek, Inc. 2012 - 2023

quest / 08/09/2023 7:24:32 PM GMT

GlobTek, Inc. www.globtek.com 186 Veterans Drive, Northvale, NJ 07647 Tel. (201) 784-1000 Fax (201) 784-0111	Drawing Title: GTM91128LI3CEL, ICT / ITE / Medical Power Supply, Efficiency Level: N/A, Case Color/Style: GlobTek Black, Wall Plug-in+Desktop Combination, Li-Ion Battery Charger, Input Rating: 100-240V~, 50-60 Hz, IEC 60320/C8 w/ Wall Blades Option , Output Rating: 12.6W, 12.6V@1.0A, Output Configuration: 1830 mm, 18/1C + Shield Cond, UL 1185, 3 Pin DC Jack, Ferrite: Core Size: 14.2*28.5*8.2, GlobTek Black, GT Cord # C9581, Pin Out: Pin 1:White(+), Pin 2: N/C, Pin 3:Shield(-), Blades/Input Cord: (Order Separately), Approvals: CB 60950; ETL; EAC; SIQ 61558; SIQ; SIQ; SIQ; S-Mark 60950; cRUus (up to 30V); cRUus; S-Mark IEC/EN 60601-1; S-Mark 62368; UKCA; CE; RoHS; China RoHS; WEEE; PSE; Ukraine; Double Insulation; ETL; CB 60335; Book 60601; VCCI; IP54;	
	Model No. GTM91128LI3CEL	
	Part No./Ordering No. GTM91128LI3C1000XFX9	Rev C

3. Earth Leakage Current: N/A for Class II units, there is no PE Ground pin, so Earth Leakage current is not measured
4. Touch Current: Maximum allowed values: 100uA NC(Normal condition) 500uA SFC(single fault condition)

E) OTHER:

01. MTBF: 300,000 Hours @ 25°C ambient temperature
02. Operating Temperature: 0°C to 35°C ambient temperature
03. Humidity: 0% to 90% relative humidity
04. Storage Temperature: -10°C to 70°C
05. Cooling: Convection

F) ENCLOSURE

01. Housing: High impact plastic, 94V0 polycarbonate, non-vented
02. Size: 53.47*117.53*36.6 +/-1.0 mm
03. Markings: Label and/or Pad Printed and/or Molded in the case
04. GREEN LED to indicate (see above electrical specifications)

TO ADDRESS SYSTEM-LEVEL EMI CONCERNS, FERRITE CHOKES/BEADS MAY BE ADDED/REVISED UPON REQUEST. A SAMPLE KIT OF GLOBTEK'S STANDARD FERRITES IS AVAILABLE UNDER GLOBTEK P/N: EMI-MITIGATION-KIT1

FOR ADDITIONAL INFORMATION, PLEASE READ OUR WHITE PAPER AT: <https://r.globtek.info/3QeaqtD>

INGRESS PROTECTION: Indoor Use

<p>GlobTek, Inc. www.globtek.com 186 Veterans Drive, Northvale, NJ 07647 Tel. (201) 784-1000 Fax (201) 784-0111</p>	<p>Drawing Title: GTM91128LI3CEL, ICT / ITE / Medical Power Supply, Efficiency Level: N/A, Case Color/Style: GlobTek Black, Wall Plug-in+Desktop Combination, Li-Ion Battery Charger, Input Rating: 100-240V~, 50-60 Hz, IEC 60320/C8 w/ Wall Blades Option , Output Rating: 12.6W, 12.6V@1.0A, Output Configuration: 1830 mm, 18/1C + Shield Cond, UL 1185, 3 Pin DC Jack, Ferrite: Core Size: 14.2*28.5*8.2, GlobTek Black, GT Cord # C9581, Pin Out: Pin 1:White(+), Pin 2: N/C, Pin 3:Shield(-), Blades/Input Cord: (Order Separately), Approvals: CB 60950; ETL; EAC; SIQ 61558; SIQ; SIQ; SIQ; S-Mark 60950; cRUus (up to 30V); cRUus; S-Mark IEC/EN 60601-1; S-Mark 62368; UKCA; CE; RoHS; China RoHS; WEEE; PSE; Ukraine; Double Insulation; ETL; CB 60335; Book 60601; VCCI; IP54;</p>
	<p>Model No. GTM91128LI3CEL</p> <p>Part No./Ordering No. GTM91128LI3C1000XF9</p> <p style="text-align: right;">Rev C</p>

Mechanical drawing

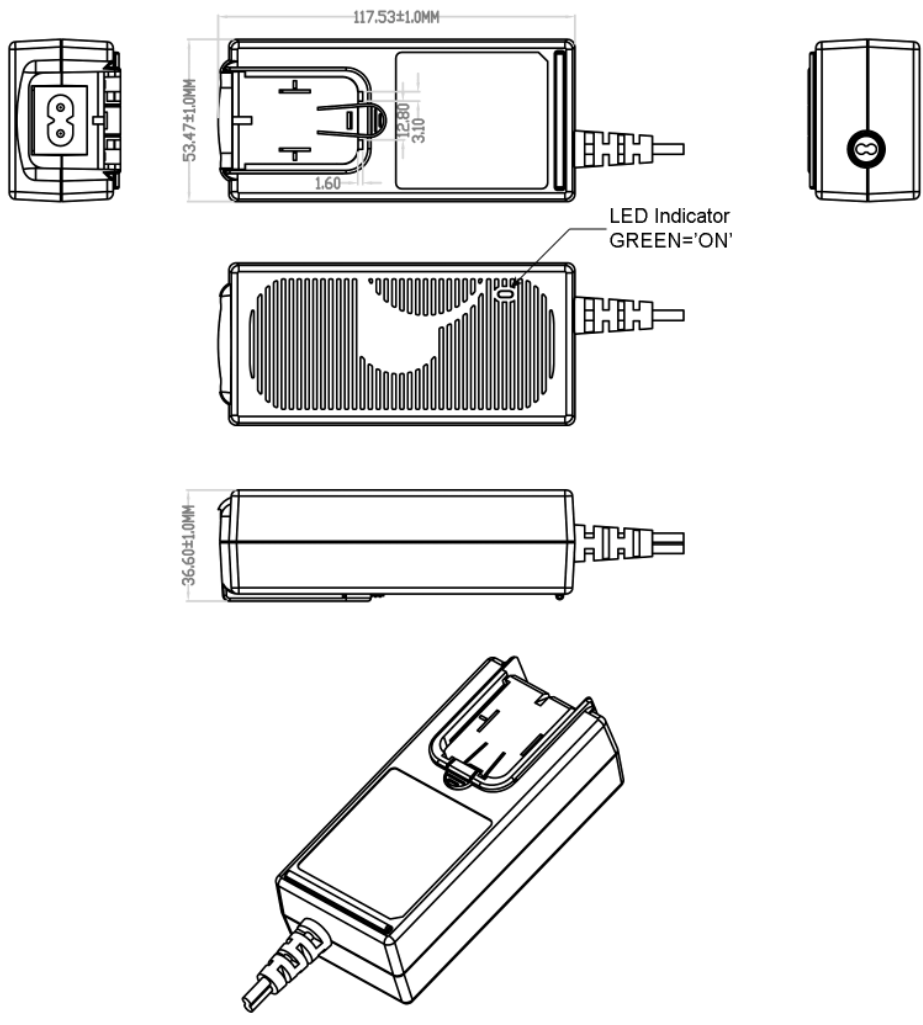

<p>GlobTek, Inc. www.globtek.com 186 Veterans Drive, Northvale, NJ 07647 Tel. (201) 784-1000 Fax (201) 784-0111</p>	<p>Drawing Title: GTM91128LI3CEL, ICT / ITE / Medical Power Supply, Efficiency Level: N/A, Case Color/Style: GlobTek Black, Wall Plug-in+Desktop Combination, Li-Ion Battery Charger, Input Rating: 100-240V~, 50-60 Hz, IEC 60320/C8 w/ Wall Blades Option , Output Rating: 12.6W, 12.6V@1.0A, Output Configuration: 1830 mm, 18/1C + Shield Cond, UL 1185, 3 Pin DC Jack, Ferrite: Core Size: 14.2*28.5*8.2, GlobTek Black, GT Cord # C9581, Pin Out: Pin 1:White(+), Pin 2: N/C, Pin 3:Shield(-), Blades/Input Cord: (Order Separately), Approvals: CB 60950; ETL; EAC; SIQ 61558; SIQ; SIQ; SIQ; S-Mark 60950; cRUus (up to 30V); cRUus; S-Mark IEC/EN 60601-1; S-Mark 62368; UKCA; CE; RoHS; China RoHS; WEEE; PSE; Ukraine; Double Insulation; ETL; CB 60335; Book 60601; VCCI; IP54;</p>
	<p>Model No. GTM91128LI3CEL</p>
	<p>Part No./Ordering No. GTM91128LI3C1000XFX9</p>
	<p>Rev C</p>

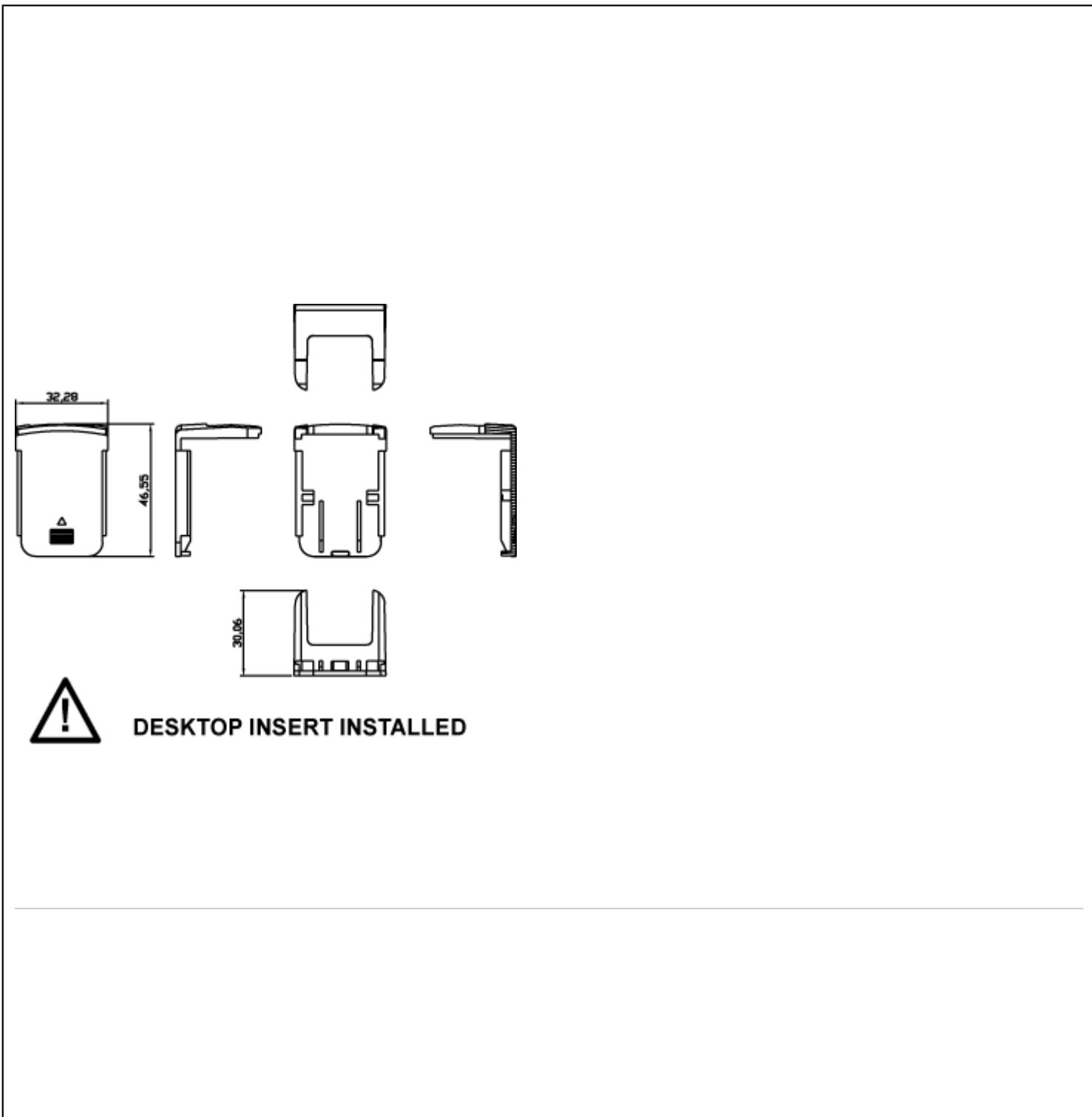

<p>GlobTek, Inc. www.globtek.com 186 Veterans Drive, Northvale, NJ 07647 Tel. (201) 784-1000 Fax (201) 784-0111</p>	<p>Drawing Title: GTM91128LI3CEL, ICT / ITE / Medical Power Supply, Efficiency Level: N/A, Case Color/Style: GlobTek Black, Wall Plug-in+Desktop Combination, Li-Ion Battery Charger, Input Rating: 100-240V~, 50-60 Hz, IEC 60320/C8 w/ Wall Blades Option , Output Rating: 12.6W, 12.6V@1.0A, Output Configuration: 1830 mm, 18/1C + Shield Cond, UL 1185, 3 Pin DC Jack, Ferrite: Core Size: 14.2*28.5*8.2, GlobTek Black, GT Cord # C9581, Pin Out: Pin 1:White(+), Pin 2: N/C, Pin 3:Shield(-), Blades/Input Cord: (Order Separately), Approvals: CB 60950; ETL; EAC; SIQ 61558; SIQ; SIQ; SIQ; S-Mark 60950; cRUus (up to 30V); cRUus; S-Mark IEC/EN 60601-1; S-Mark 62368; UKCA; CE; RoHS; China RoHS; WEEE; PSE; Ukraine; Double Insulation; ETL; CB 60335; Book 60601; VCCI; IP54;</p> <p>Model No. GTM91128LI3CEL</p> <p>Part No./Ordering No. GTM91128LI3C1000XFX9</p>	<p>Rev C</p>
--	---	--------------

DERATING CURVE

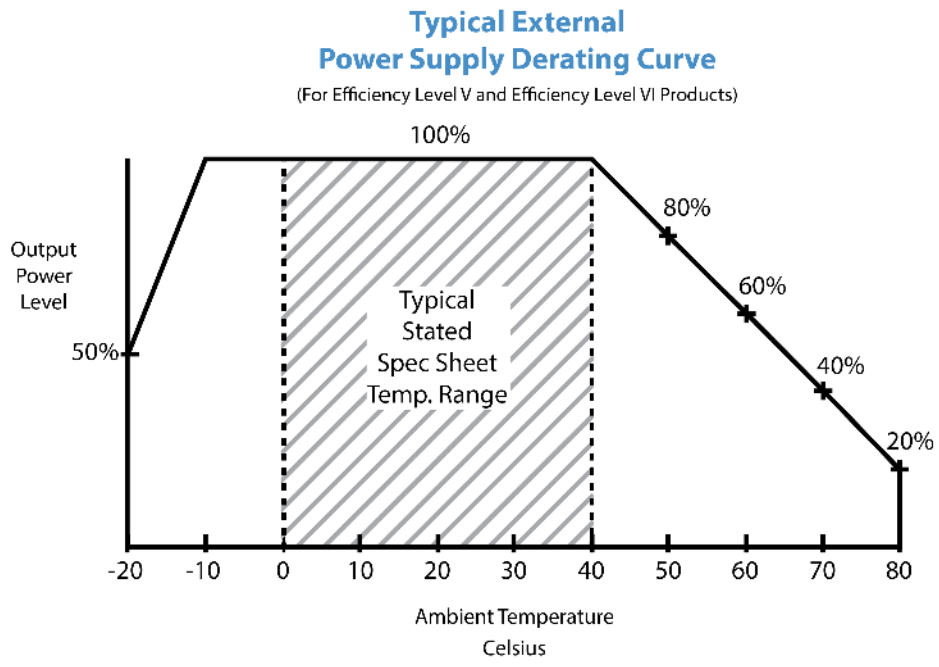

GloTek, Inc. www.globtek.com 186 Veterans Drive, Northvale, NJ 07647 Tel. (201) 784-1000 Fax (201) 784-0111	Drawing Title: GTM91128LI3CEL, ICT / ITE / Medical Power Supply, Efficiency Level: N/A, Case Color/Style: GlobTek Black, Wall Plug-in+Desktop Combination, Li-Ion Battery Charger, Input Rating: 100-240V~, 50-60 Hz, IEC 60320/C8 w/ Wall Blades Option , Output Rating: 12.6W, 12.6V@1.0A, Output Configuration: 1830 mm, 18/1C + Shield Cond, UL 1185, 3 Pin DC Jack, Ferrite: Core Size: 14.2*28.5*8.2, GlobTek Black, GT Cord # C9581, Pin Out: Pin 1:White(+), Pin 2: N/C, Pin 3:Shield(-), Blades/Input Cord: (Order Separately), Approvals: CB 60950; ETL; EAC; SIQ 61558; SIQ; SIQ; SIQ; S-Mark 60950; cRUus (up to 30V); cRUus; S-Mark IEC/EN 60601-1; S-Mark 62368; UKCA; CE; RoHS; China RoHS; WEEE; PSE; Ukraine; Double Insulation; ETL; CB 60335; Book 60601; VCCI; IP54;	
	Model No. GTM91128LI3CEL	
	Part No./Ordering No. GTM91128LI3C1000XFX9	Rev C

INPUT CONFIGURATION

(F1) Class II / Double Insulated



[Alternate grounding configurations](#) available upon request.

Blades/Cord Included:None:(Order Separately)

Blades/Cord Installed:None:(Order Separately)

IEC 60320/C8 AC Inlet connector

[Blade Insertion Instructions](#)
[R-Blade Style Instruction Video](#)

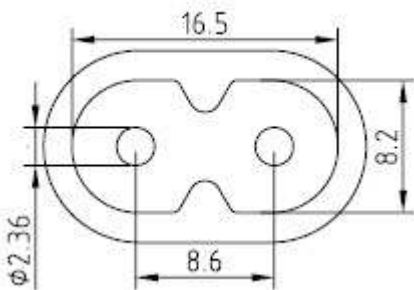

Mates with IEC 60320/C8 Plug

This series of Interchangeable Blade products may be used with Proprietary Interchangeable Blades as described below or with standard international power cords.

Optional INPUT BLADES: R-Socket: below are available blades configurations which are "not included" (unless stated above); may be purchased separately, packaged with power supply, or as a separate "R-KIT" if specified

#	Part Number	Main Country/Region	Plug	IECEE Type
1	R-NA-2(R)	North America, Japan	Nema 1-15P	Type A

PROPRIETARY INFORMATION

PROPRIETARY OF GLOBTEK, INC. ANY REPRODUCTION, DISCLOSURE OR USE OF THIS DRAWING, IN WHOLE OR IN PART, IS HEREBY PROHIBITED EXCEPT AS SPECIFIED IN

WRITING BY GLOBTEK, INC. © GlobTek, Inc. 2012 - 2023

quest / 08/09/2023 7:24:32 PM GMT

GlobTek, Inc. www.globtek.com 186 Veterans Drive, Northvale, NJ 07647 Tel. (201) 784-1000 Fax (201) 784-0111	Drawing Title: GTM91128LI3CEL, ICT / ITE / Medical Power Supply, Efficiency Level: N/A, Case Color/Style: GlobTek Black, Wall Plug-in+Desktop Combination, Li-Ion Battery Charger, Input Rating: 100-240V~, 50-60 Hz, IEC 60320/C8 w/ Wall Blades Option , Output Rating: 12.6W, 12.6V@1.0A, Output Configuration: 1830 mm, 18/1C + Shield Cond, UL 1185, 3 Pin DC Jack, Ferrite: Core Size: 14.2*28.5*8.2, GlobTek Black, GT Cord # C9581, Pin Out: Pin 1:White(+), Pin 2: N/C, Pin 3:Shield(-), Blades/Input Cord: (Order Separately), Approvals: CB 60950; ETL; EAC; SIQ 61558; SIQ; SIQ; SIQ; S-Mark 60950; cRUus (up to 30V); cRUus; S-Mark IEC/EN 60601-1; S-Mark 62368; UKCA; CE; RoHS; China RoHS; WEEE; PSE; Ukraine; Double Insulation; ETL; CB 60335; Book 60601; VCCI; IP54;	
	Model No. GTM91128LI3CEL	
	Part No./Ordering No. GTM91128LI3C1000XFX9	Rev C

2 R-SAA-2(R)	Australia/New Zealand	AS/NZ 3112	Type I
3 R-UK-2(R)	United Kingdom/Ireland	UK, Hong Kong, Singapore, Gulf States	Type G
4 R-EU-2(R)	Europe	CEE 7/16	Type C
5 R-CN-2(R)	China	GB 2099	Type A
6 461-03030003(R) N/A		R-DI(R) Desktop Insert for use with a cord	N/A
7 R-KIT-2(R)	prepackaged kit	1,2,3,4 above	N/A
8 R-KIT-2-INTL(R)	prepackaged kit	2,3,4 above	N/A



UL 2P
 P/N: R-NA-2(R)
 NORTH AMERICA
 JAPAN



AUS 2P
 P/N: R-SAA-2(R)
 AUSTRALIA

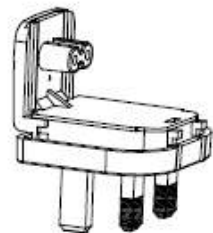

UK 2P
 P/N: R-UK-2(R)
 UNITED KINGDOM
 HONG KONG
 SINGAPORE

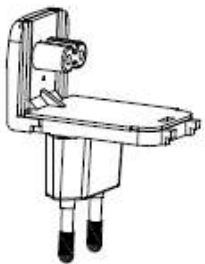

EU 2P
 P/N: R-EU-2(R)
 EUROPE
 SOUTH AMERICA



CN 2P
 P/N: R-CN-2(R)
 CHINA



R-DI
 P/N: R-DI
 DESKTOP INSERT

GlobTek, Inc. www.globtek.com 186 Veterans Drive, Northvale, NJ 07647 Tel. (201) 784-1000 Fax (201) 784-0111	Drawing Title: GTM91128LI3CEL, ICT / ITE / Medical Power Supply, Efficiency Level: N/A, Case Color/Style: GlobTek Black, Wall Plug-in+Desktop Combination, Li-Ion Battery Charger, Input Rating: 100-240V~, 50-60 Hz, IEC 60320/C8 w/ Wall Blades Option , Output Rating: 12.6W, 12.6V@1.0A, Output Configuration: 1830 mm, 18/1C + Shield Cond, UL 1185, 3 Pin DC Jack, Ferrite: Core Size: 14.2*28.5*8.2, GlobTek Black, GT Cord # C9581, Pin Out: Pin 1:White(+), Pin 2: N/C, Pin 3:Shield(-), Blades/Input Cord: (Order Separately), Approvals: CB 60950; ETL; EAC; SIQ 61558; SIQ; SIQ; SIQ; S-Mark 60950; cRUus (up to 30V); cRUus; S-Mark IEC/EN 60601-1; S-Mark 62368; UKCA; CE; RoHS; China RoHS; WEEE; PSE; Ukraine; Double Insulation; ETL; CB 60335; Book 60601; VCCI; IP54;	
	Model No. GTM91128LI3CEL	
	Part No./Ordering No. GTM91128LI3C1000XF9	Rev C

Standard Cordsets

Below are standard cordsets which are "not included" (unless stated above); these may be purchased separately or packaged with the power supply. Contact your Sales Engineer if the style required is not shown below. Many more available in different lengths, colors or cable material.

[Standard International IEC 320/C7 Cordsets](#)

Part Number	Country	Plug	Connector	Length (mm)	Length (feet)
<u>2094112M703(R)</u>	Argentina (Type I)	IRAM 2063	IEC 320/C7	2000	7
<u>5014112M703A(R)</u>	Australian (Type I)	AS 3112	IEC 320/C7	2000	7
<u>207B4111M8703(R)</u>	Brazil (Type N)	NBR14136	IEC 320/C7	1800	6
<u>4533501M8703(R)</u>	China (Type A)	GB 2099.1	IEC 320/C7	1830	6
<u>2074112M703A(R)</u>	European (Type C)	CEE 7/16	IEC 320/C7	2000	7
<u>2084111M8703(R)</u>	South Africa (Type M)	BS 546	IEC 320/C7	1800	6
2084111M8703B(R)	India (Type D)	ISI:1293	IEC 320/C7	1800	6
<u>2714111M8703A(R)</u>	India (Type C)	ISI:1293	IEC 320/C7	1800	6
<u>451J3401M8703(R)</u>	Japan (Type A)	JIS 8303	IEC 320/C7	1830	6
<u>2044112M703A(R)</u>	Korea (Type C)	KS C8305	IEC 320/C7	2000	7
<u>4511116F703A(R)</u>	N. American (Type A)	NEMA 1-15P	IEC 320/C7	1830	6
<u>4033401M8703A(R)</u>	Taiwan (Type A)	CNS690	IEC 320/C7	1830	6
<u>6104112M703A(R)</u>	UK, Hong Kong, Singapore, Gulf States (Type G)	BS1363	IEC 320/C7	2000	7

GlobTek, Inc. www.globtek.com 186 Veterans Drive, Northvale, NJ 07647 Tel. (201) 784-1000 Fax (201) 784-0111	Drawing Title: GTM91128LI3CEL, ICT / ITE / Medical Power Supply, Efficiency Level: N/A, Case Color/Style: GlobTek Black, Wall Plug-in+Desktop Combination, Li-Ion Battery Charger, Input Rating: 100-240V~, 50-60 Hz, IEC 60320/C8 w/ Wall Blades Option , Output Rating: 12.6W, 12.6V@1.0A, Output Configuration: 1830 mm, 18/1C + Shield Cond, UL 1185, 3 Pin DC Jack, Ferrite: Core Size: 14.2*28.5*8.2, GlobTek Black, GT Cord # C9581, Pin Out: Pin 1:White(+), Pin 2: N/C, Pin 3:Shield(-), Blades/Input Cord: (Order Separately), Approvals: CB 60950; ETL; EAC; SIQ 61558; SIQ; SIQ; SIQ; S-Mark 60950; cRUus (up to 30V); cRUus; S-Mark IEC/EN 60601-1; S-Mark 62368; UKCA; CE; RoHS; China RoHS; WEEE; PSE; Ukraine; Double Insulation; ETL; CB 60335; Book 60601; VCCI; IP54;	
	Model No. GTM91128LI3CEL	Rev C
	Part No./Ordering No. GTM91128LI3C1000XF9	

OUTPUT CORD AND CONNECTOR: FX9-3/C9581

ACTUAL CONNECTORS, OVERMOLDS, FERRITES MAY VARY SLIGHTLY FROM THE PICTURE BELOW

CABLE TYPE	UL 1185
CABLE LENGTH (mm)	1830
CABLE TOLERANCE (mm)	+150-0
WIRE GAUGE (AWG)	18
CONDUCTORS	1C + Shield
HANK DIMENSION (mm)	80 +10 -10
CABLE / CONNECTOR OVERMOLD COLOR	GlobTek Black
FERRITE TYPE AND DIMENSION	Core Size: 14.2*28.5*8.2
FERRITE NUMBER OF TURNS(Definition)	1 Pass thru core (0 turns)
FERRITE DIMENSION FROM STRAIN RELIEF	50 ±10
FERRITE DIMENSION FROM PLUG	N/A
PLUG TYPE	3 Pin DC Jack
OUTPUT CONNECTOR GENDER	Female
OVERMOLDED	Yes
OVER MOLD ORIENTATION	Straight
CONNECTOR PIN OUT	Pin 1:White(+), Pin 2: N/C, Pin 3:Shield(-)

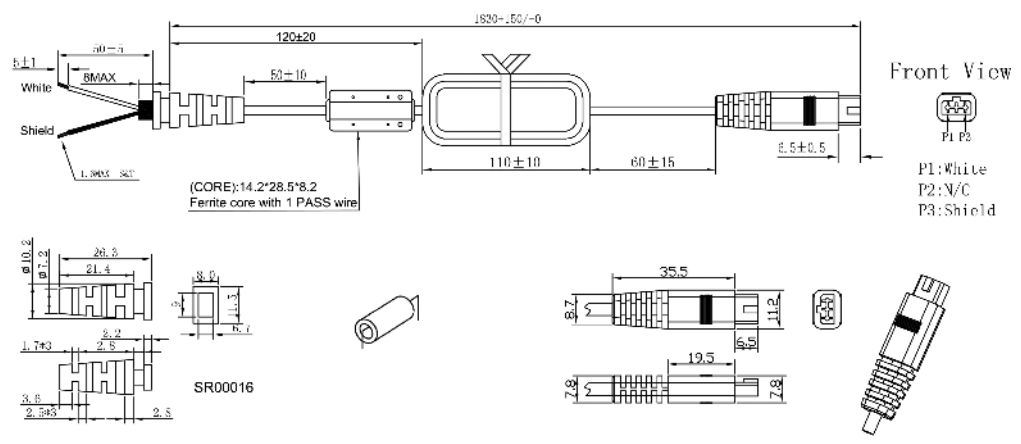

ADDITIONAL OUTPUT PLUG OPTIONS ARE AVAILABLE AT <https://www.globtek.com/connectors/>
 STANDARD PLUGS AND CONNECTORS CAN BE SEEN ONLINE AT <https://www.globtek.com/connectors/>
 CALCULATE VOLTAGE REGULATION/DROP WITH OUR ONLINE CALCULATOR: <https://en.globtek.com/output-cable-regulation-calculator/>

<p>GlobTek, Inc. www.globtek.com 186 Veterans Drive, Northvale, NJ 07647 Tel. (201) 784-1000 Fax (201) 784-0111</p>	<p>Drawing Title: GTM91128LI3CEL, ICT / ITE / Medical Power Supply, Efficiency Level: N/A, Case Color/Style: GlobTek Black, Wall Plug-in+Desktop Combination, Li-Ion Battery Charger, Input Rating: 100-240V~, 50-60 Hz, IEC 60320/C8 w/ Wall Blades Option , Output Rating: 12.6W, 12.6V@1.0A, Output Configuration: 1830 mm, 18/1C + Shield Cond, UL 1185, 3 Pin DC Jack, Ferrite: Core Size: 14.2*28.5*8.2, GlobTek Black, GT Cord # C9581, Pin Out: Pin 1:White(+), Pin 2: N/C, Pin 3:Shield(-), Blades/Input Cord: (Order Separately), Approvals: CB 60950; ETL; EAC; SIQ 61558; SIQ; SIQ; SIQ; S-Mark 60950; cRUus (up to 30V); cRUus; S-Mark IEC/EN 60601-1; S-Mark 62368; UKCA; CE; RoHS; China RoHS; WEEE; PSE; Ukraine; Double Insulation; ETL; CB 60335; Book 60601; VCCI; IP54;</p>
	<p>Model No. GTM91128LI3CEL</p>
	<p>Part No./Ordering No. GTM91128LI3C1000XFX9</p>
	<p>Rev C</p>

OUTPUT CONNECTOR HOOK UP

TO ADDRESS SYSTEM-LEVEL EMI CONCERNS, FERRITE CHOKES/BEADS MAY BE ADDED/REVISED UPON REQUEST. A SAMPLE KIT OF GLOBTEK'S STANDARD FERRITES IS AVAILABLE UNDER GLOBTEK P/N: EMI-MITIGATION-KIT1

FOR ADDITIONAL INFORMATION, PLEASE READ OUR WHITE PAPER AT:

<https://en.globtek.com/technical-articles/ferrite-kit-radiated-emi-suppression-kit-for-globtek-power-supplies-cable-assemblies>

GlobTek, Inc. www.globtek.com 186 Veterans Drive, Northvale, NJ 07647 Tel. (201) 784-1000 Fax (201) 784-0111	Drawing Title: GTM91128LI3CEL, ICT / ITE / Medical Power Supply, Efficiency Level: N/A, Case Color/Style: GlobTek Black, Wall Plug-in+Desktop Combination, Li-Ion Battery Charger, Input Rating: 100-240V~, 50-60 Hz, IEC 60320/C8 w/ Wall Blades Option , Output Rating: 12.6W, 12.6V@1.0A, Output Configuration: 1830 mm, 18/1C + Shield Cond, UL 1185, 3 Pin DC Jack, Ferrite: Core Size: 14.2*28.5*8.2, GlobTek Black, GT Cord # C9581, Pin Out: Pin 1:White(+), Pin 2: N/C, Pin 3:Shield(-), Blades/Input Cord: (Order Separately), Approvals: CB 60950; ETL; EAC; SIQ 61558; SIQ; SIQ; SIQ; S-Mark 60950; cRUus (up to 30V); cRUus; S-Mark IEC/EN 60601-1; S-Mark 62368; UKCA; CE; RoHS; China RoHS; WEEE; PSE; Ukraine; Double Insulation; ETL; CB 60335; Book 60601; VCCI; IP54;	
	Model No. GTM91128LI3CEL	
	Part No./Ordering No. GTM91128LI3C1000XFX9	Rev C

LABEL:L-1555

LABEL P/N	GTM91128LIXCEL label
MATERIAL	Flat Thermal Transfer, Imprintable, Polyester Label and/or Pad Printed and/or Molded, and/or Laser Engraved in the case
BACKGROUND COLOR	Black if housing is Black, White or Silver if housing is White or Gray.
TEXT COLOR	White or Silver if label is Black Background for Black housing. Black if label is White or Silver background and Housing is White or Gray.
LABEL WIDTH (mm)	45.0
LABEL HEIGHT (mm)	50.0
SPECIAL BARCODE LABEL MATERIAL	No

Below is the minimum information which will appear on the label. NOTE: in the logo area additional/actual positioning of symbols and text is subjected to change as per agency updates/requirements or additional model approvals become available.
Regulatory certifications/label markings may be in logo area on the label or molded into the case housing outside the label area.
Information will be shown via label and/or pad printed and/or molded and/or laser engraved in the case. * Date code markings at GlobTek option.

1. Add on the label:

Charge Status Indicator

Description	LED Status
Charging	Solid Amber
Charge Complete	Solid Green
No Battery or Fault	Green and Amber LED off

2. Add "Li-Ion BATTERY CHARGER" below line 'A'

GlobTek, Inc. www.globtek.com 186 Veterans Drive, Northvale, NJ 07647 Tel. (201) 784-1000 Fax (201) 784-0111	Drawing Title: GTM91128LI3CEL, ICT / ITE / Medical Power Supply, Efficiency Level: N/A, Case Color/Style: GlobTek Black, Wall Plug-in+Desktop Combination, Li-Ion Battery Charger, Input Rating: 100-240V~, 50-60 Hz, IEC 60320/C8 w/ Wall Blades Option , Output Rating: 12.6W, 12.6V@1.0A, Output Configuration: 1830 mm, 18/1C + Shield Cond, UL 1185, 3 Pin DC Jack, Ferrite: Core Size: 14.2*28.5*8.2, GlobTek Black, GT Cord # C9581, Pin Out: Pin 1:White(+), Pin 2: N/C, Pin 3:Shield(-), Blades/Input Cord: (Order Separately), Approvals: CB 60950; ETL; EAC; SIQ 61558; SIQ; SIQ; SIQ; S-Mark 60950; cRUus (up to 30V); cRUus; S-Mark IEC/EN 60601-1; S-Mark 62368; UKCA; CE; RoHS; China RoHS; WEEE; PSE; Ukraine; Double Insulation; ETL; CB 60335; Book 60601; VCCI; IP54;
	Model No. GTM91128LI3CEL Part No./Ordering No. GTM91128LI3C1000XF9

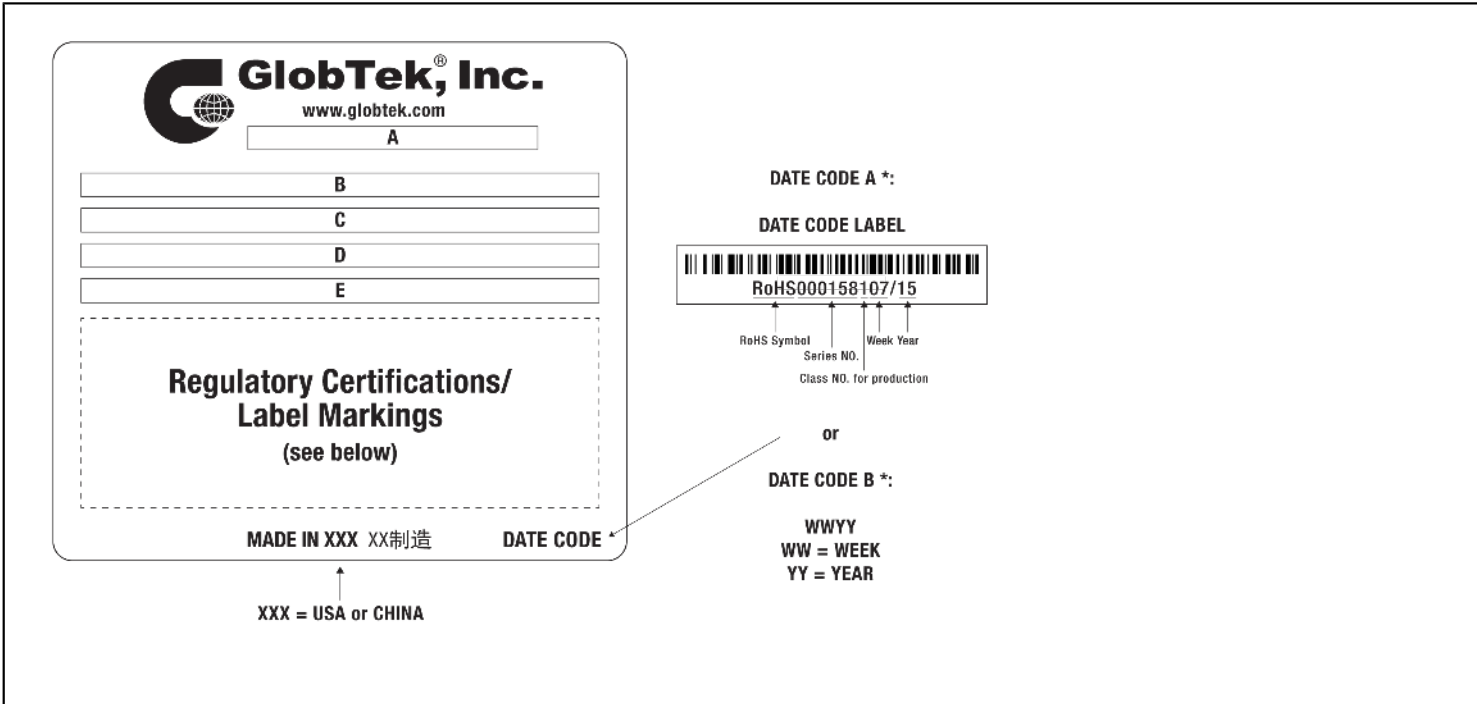

- A=ICT / ITE / Medical Power Supply
- B=P/N: (料号) GTM91128LI3C1000XF9
- C=Model (型号) GTM91128LI3CEL
- D=Input (输入)100-240V~, 50-60 Hz, 1.5A
- E=Output (输出)12.6 V 1.0 A, 12.60W

GlobTek, Inc. www.globtek.com 186 Veterans Drive, Northvale, NJ 07647 Tel. (201) 784-1000 Fax (201) 784-0111	Drawing Title: GTM91128LI3CEL, ICT / ITE / Medical Power Supply, Efficiency Level: N/A, Case Color/Style: GlobTek Black, Wall Plug-in+Desktop Combination, Li-Ion Battery Charger, Input Rating: 100-240V~, 50-60 Hz, IEC 60320/C8 w/ Wall Blades Option , Output Rating: 12.6W, 12.6V@1.0A, Output Configuration: 1830 mm, 18/1C + Shield Cond, UL 1185, 3 Pin DC Jack, Ferrite: Core Size: 14.2*28.5*8.2, GlobTek Black, GT Cord # C9581, Pin Out: Pin 1:White(+), Pin 2: N/C, Pin 3:Shield(-), Blades/Input Cord: (Order Separately), Approvals: CB 60950; ETL; EAC; SIQ 61558; SIQ; SIQ; SIQ; S-Mark 60950; cRUus (up to 30V); cRUus; S-Mark IEC/EN 60601-1; S-Mark 62368; UKCA; CE; RoHS; China RoHS; WEEE; PSE; Ukraine; Double Insulation; ETL; CB 60335; Book 60601; VCCI; IP54;	
	Model No. GTM91128LI3CEL	
	Part No./Ordering No. GTM91128LI3C1000XFX9	Rev C

AGENCY ONLINE DOCUMENTS	http://globtek.info/certs/GTM91128%20Lithium%20Ion%20Battery/
CE EC-Declaration for Medical	Contact GlobTek for more information
CE EC-Declaration for Industrial/Commercial/ITE	http://globtek.force.com/models/ec_declaration_product?id=01ta0000003dRHZ&i=3
CE EC-Declaration for Household	Contact GlobTek for more information
UKCA-Declaration for Medical	Contact GlobTek for more information
UKCA-Declaration for Industrial/Commercial/ITE	http://globtek.force.com/models/ukca_declaration_product?id=01ta0000003dRHZ&i=3
UKCA-Declaration for Household	Contact GlobTek for more information
Morocco SDoC Declaration	https://globtek.secure.force.com/models/Morocco_SDoC_Declaration?id=a0Oa000000C2KH4EAN
RoHS/RoHS3 Declaration	https://www.globtek.com/pdf/rohs_cert/01ta0000003dRHZAAM
REACH Declaration	https://www.globtek.com/pdf/iso_certificates/REACH.pdf
Conflict Minerals Declaration	https://www.globtek.com/pdf/conflict-minerals.pdf
Prop 65 Statement	https://en.globtek.com/prop-65-statement.pdf
IPXY rating is based on 3rd party testing and customers should check suitability and test system level IPXY rating before ordering.	

Regulatory Certifications/Label Markings

Below follows a link to the latest regulatory certifications and marks for this specific product. National standards as well as certification schemes are constantly changing and so is the set of certification marks and symbols applicable to this product. Various standards, marks and symbols, and certificates are subject to change at any time without notice.

Additional standards or unique country certifications are available upon request. Please contact Globtek to request a quotation.

LATEST PRODUCT/MODEL CERTIFICATIONS:	https://www.globtek.com/datasheet/w70754
AGENCY ONLINE DOCUMENTS	http://globtek.info/certs/GTM91128%20Lithium%20Ion%20Battery/



(F1) Class II / Double Insulated

Front View

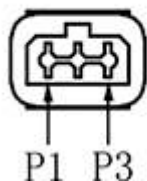

Pin 1:White(+), Pin 2: N/C, Pin 3:Shield(-)

GlobTek, Inc. www.globtek.com 186 Veterans Drive, Northvale, NJ 07647 Tel. (201) 784-1000 Fax (201) 784-0111	Drawing Title: GTM91128LI3CEL, ICT / ITE / Medical Power Supply, Efficiency Level: N/A, Case Color/Style: GlobTek Black, Wall Plug-in+Desktop Combination, Li-Ion Battery Charger, Input Rating: 100-240V~, 50-60 Hz, IEC 60320/C8 w/ Wall Blades Option , Output Rating: 12.6W, 12.6V@1.0A, Output Configuration: 1830 mm, 18/1C + Shield Cond, UL 1185, 3 Pin DC Jack, Ferrite: Core Size: 14.2*28.5*8.2, GlobTek Black, GT Cord # C9581, Pin Out: Pin 1:White(+), Pin 2: N/C, Pin 3:Shield(-), Blades/Input Cord: (Order Separately), Approvals: CB 60950; ETL; EAC; SIQ 61558; SIQ; SIQ; SIQ; S-Mark 60950; cRUus (up to 30V); cRUus; S-Mark IEC/EN 60601-1; S-Mark 62368; UKCA; CE; RoHS; China RoHS; WEEE; PSE; Ukraine; Double Insulation; ETL; CB 60335; Book 60601; VCCI; IP54;	
	Model No. GTM91128LI3CEL	
	Part No./Ordering No. GTM91128LI3C1000XFX9	Rev C

PACKAGING

Packing Spec P/N	Standard WPI, Individually Box, User manual DT
Box Qty	60
Gift Box Size (mm)	160*67*70
Gift Box Color	White
Master Carton Size (mm)	510 x 430 x 270
Master Carton Cubic Volume (m³)	0.06
Master GW (Kg)	15.9 kg
BLADES INCLUDED	None: (Order Separately)
BLADE/CORD INSTALLED	None: (Order Separately)
USER MANUAL*	809-DESKTOPUSERMANUAL on A4 paper
USER MANUAL WEB LINK	https://en.globtek.com/pdf/809-DESKTOPUSERMANUAL.jpg

* This specification sheet is considered the user manual for all applications. It is expected that the buyer of this product will use it to formulate their own user manual for their end product and a user manual specifically for the power adapter is not usually required. If a user manual is not specifically listed above then none will be provided with this unit.

If specific packaging is required, this section must specify all requirements and note "no exceptions". If this section does not specify packaging, it is subject to change without notice at GlobTek's discretion

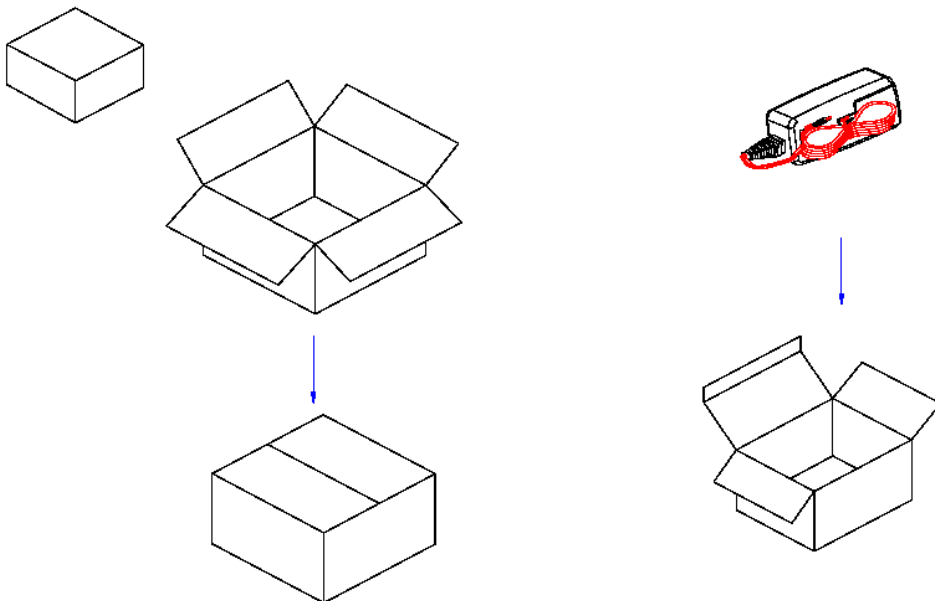

PROPRIETARY INFORMATION

<p>GlobTek, Inc. www.globtek.com 186 Veterans Drive, Northvale, NJ 07647 Tel. (201) 784-1000 Fax (201) 784-0111</p>	<p>Drawing Title: GTM91128LI3CEL, ICT / ITE / Medical Power Supply, Efficiency Level: N/A, Case Color/Style: GlobTek Black, Wall Plug-in+Desktop Combination, Li-Ion Battery Charger, Input Rating: 100-240V~, 50-60 Hz, IEC 60320/C8 w/ Wall Blades Option , Output Rating: 12.6W, 12.6V@1.0A, Output Configuration: 1830 mm, 18/1C + Shield Cond, UL 1185, 3 Pin DC Jack, Ferrite: Core Size: 14.2*28.5*8.2, GlobTek Black, GT Cord # C9581, Pin Out: Pin 1:White(+), Pin 2: N/C, Pin 3:Shield(-), Blades/Input Cord: (Order Separately), Approvals: CB 60950; ETL; EAC; SIQ 61558; SIQ; SIQ; SIQ; S-Mark 60950; cRUus (up to 30V); cRUus; S-Mark IEC/EN 60601-1; S-Mark 62368; UKCA; CE; RoHS; China RoHS; WEEE; PSE; Ukraine; Double Insulation; ETL; CB 60335; Book 60601; VCCI; IP54;</p>
	<p>Model No. GTM91128LI3CEL</p>
	<p>Part No./Ordering No. GTM91128LI3C1000XFX9</p>
	<p>Rev C</p>

INSTRUCTIONS TO THE OEM SYSTEMS ENGINEER

It is the responsibility of the OEM systems engineer to provide the end system user instructions and warnings for the use of this product in the end system.

If an input cord is required for this product, AC Mains voltage should be provided to the power supply by a power supply cord approved to the national standards of the country in which it will be used.

This product is not designed to be repaired. No serviceable parts inside. A blown internal fuse is an indication of catastrophic failure of circuit component(s). If a Failure Analysis is required for a failed power supply/battery charger, please return the damaged unit to GlobTek for an accurate determination of the root cause of the failure.

EMC Compliance of the complete OEM product, including the GlobTek power supply/battery charger needs to be verified by the OEM systems engineer.

INSTRUCTION SHEET

N/A

<p>GlobTek, Inc. www.globtek.com 186 Veterans Drive, Northvale, NJ 07647 Tel. (201) 784-1000 Fax (201) 784-0111</p>	<p>Drawing Title: GTM91128LI3CEL, ICT / ITE / Medical Power Supply, Efficiency Level: N/A, Case Color/Style: GlobTek Black, Wall Plug-in+Desktop Combination, Li-Ion Battery Charger, Input Rating: 100-240V~, 50-60 Hz, IEC 60320/C8 w/ Wall Blades Option , Output Rating: 12.6W, 12.6V@1.0A, Output Configuration: 1830 mm, 18/1C + Shield Cond, UL 1185, 3 Pin DC Jack, Ferrite: Core Size: 14.2*28.5*8.2, GlobTek Black, GT Cord # C9581, Pin Out: Pin 1:White(+), Pin 2: N/C, Pin 3:Shield(-), Blades/Input Cord: (Order Separately), Approvals: CB 60950; ETL; EAC; SIQ 61558; SIQ; SIQ; SIQ; S-Mark 60950; cRUus (up to 30V); cRUus; S-Mark IEC/EN 60601-1; S-Mark 62368; UKCA; CE; RoHS; China RoHS; WEEE; PSE; Ukraine; Double Insulation; ETL; CB 60335; Book 60601; VCCI; IP54;</p>
	<p>Model No. GTM91128LI3CEL</p>
	<p>Part No./Ordering No. GTM91128LI3C1000XFX9</p>
	<p>Rev C</p>

