

# MC74AC259, MC74ACT259

## 8-Bit Addressable Latch

The MC74AC259/74ACT259 is a high-speed 8-bit addressable latch designed for general purpose storage applications in digital systems. It is a multifunctional device capable of storing single line data in eight addressable latches, and also a 1-of-8 decoder and demultiplexer with active HIGH outputs. The device also incorporates an active LOW Common Clear for resetting all latches, as well as an active LOW Enable. It is functionally identical to the ALS259 8-bit addressable latch.

- Serial-to-Parallel Conversion
- Eight Bits of Storage with Output of Each Bit Available
- Random (Addressable) Data Entry
- Active High Demultiplexing or Decoding Capability
- Easily Expandable
- Common Clear
- Pb-Free Packages are Available

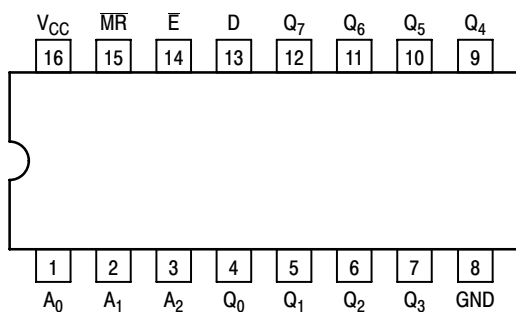

Figure 1. Pinout: 16-Lead Packages Conductors (Top View)

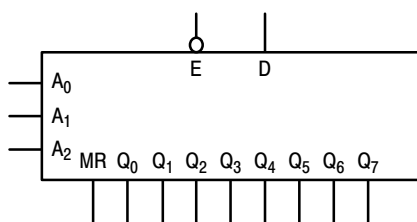

Figure 2. Logic Symbol

### MODE SELECT TABLE

| $\bar{E}$ | $\bar{MR}$ | Mode                                |
|-----------|------------|-------------------------------------|
| L         | H          | Addressable Latch                   |
| H         | H          | Memory                              |
| L         | L          | Active HIGH 8-Channel Demultiplexer |
| H         | L          | Clear                               |

H = HIGH Voltage Level  
L = LOW Voltage Level



ON Semiconductor®

<http://onsemi.com>

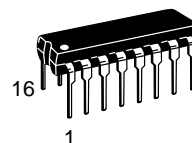

PDIP-16  
N SUFFIX  
CASE 648

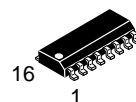

SOIC-16  
D SUFFIX  
CASE 751B

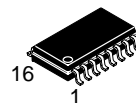

SOEIAJ-16  
M, MEL SUFFIX  
CASE 966

### DEVICE MARKING INFORMATION

See general marking information in the device marking section on page 9 of this data sheet.

### ORDERING INFORMATION

See detailed ordering and shipping information in the package dimensions section on page 9 of this data sheet.

# MC74AC259, MC74ACT259

**MODE SELECT-FUNCTION TABLE**

| Operating Mode  | Inputs          |   |   |                |                |                | Outputs        |                |                |                |                |                |                |                |
|---|-----------------|---|---|----------------|----------------|----------------|----------------|----------------|----------------|----------------|----------------|----------------|----------------|----------------|
|   | $\overline{MR}$ | E | D | A <sub>0</sub> | A <sub>1</sub> | A <sub>2</sub> | Q <sub>0</sub> | Q <sub>1</sub> | Q <sub>2</sub> | Q <sub>3</sub> | Q <sub>4</sub> | Q <sub>5</sub> | Q <sub>6</sub> | Q <sub>7</sub> |
| Master Reset  | L               | H | X | X              | X              | X              | L              | L              | L              | L              | L              | L              | L              | L              |
| Demultiplex<br>(Active HIGH<br>Decoder when<br>D = H) | L               | L | d | L              | L              | L              | Q = d          | L              | L              | L              | L              | L              | L              | L              |
|   | L               | L | d | H              | L              | L              | L              | Q = d          | L              | L              | L              | L              | L              | L              |
|   | L               | L | d | L              | H              | L              | L              | L              | Q = d          | L              | L              | L              | L              | L              |
|   | •               | • | • | •              | •              | •              | •              | •              | •              | •              | •              | •              | •              | •              |
|   | •               | • | • | •              | •              | •              | •              | •              | •              | •              | •              | •              | •              | •              |
|   | •               | • | • | •              | •              | •              | •              | •              | •              | •              | •              | •              | •              | •              |
| Store<br>(Do Nothing)                                 | H               | H | X | X              | X              | X              | q <sub>0</sub> | q <sub>1</sub> | q <sub>2</sub> | q <sub>3</sub> | q <sub>4</sub> | q <sub>5</sub> | q <sub>6</sub> | q <sub>7</sub> |
| Addressable<br>Latch                                  | H               | L | d | L              | L              | L              | Q = d          | q <sub>1</sub> | q <sub>2</sub> | q <sub>3</sub> | q <sub>4</sub> | q <sub>5</sub> | q <sub>6</sub> | q <sub>7</sub> |
|   | H               | L | d | H              | L              | L              | q <sub>0</sub> | Q = d          | q <sub>2</sub> | q <sub>3</sub> | q <sub>4</sub> | q <sub>5</sub> | q <sub>6</sub> | q <sub>7</sub> |
|   | H               | L | d | L              | H              | L              | q <sub>0</sub> | q <sub>1</sub> | Q = d          | q <sub>3</sub> | q <sub>4</sub> | q <sub>5</sub> | q <sub>6</sub> | q <sub>7</sub> |
|   | •               | • | • | •              | •              | •              | •              | •              | •              | •              | •              | •              | •              | •              |
|   | •               | • | • | •              | •              | •              | •              | •              | •              | •              | •              | •              | •              | •              |
|   | •               | • | • | •              | •              | •              | •              | •              | •              | •              | •              | •              | •              | •              |
| H   | L               | d | H | H              | H              | q <sub>0</sub> | q <sub>1</sub> | q <sub>2</sub> | q <sub>3</sub> | q <sub>4</sub> | q <sub>5</sub> | q <sub>6</sub> | Q = d          |                |

H = HIGH Voltage Level

L = LOW Voltage Level

X = Immaterial

d = HIGH or LOW Data one setup time prior to the LOW-to-HIGH Enable transition

q = Lower case letters indicate the state of the referenced output established during the last cycle in which it was addressed or cleared.

## FUNCTIONAL DESCRIPTION

The MC74AC259/74ACT259 has four modes of operation as shown in the Mode Selection Table. In the addressable latch mode, data on the Data line (D) is written into the addressed latch. The addressed latch will follow the data input with all non-addressed latches remaining in their previous states in the memory mode. All latches remain in their previous state and are unaffected by the Data or Address inputs.

In the one-of-eight decoding or demultiplexing mode, the addressed output will follow the state of the D input with all other outputs in the LOW state. In the clear mode all outputs are LOW and unaffected by the address and data inputs. When operating the MC74AC/ACT259 as an addressable latch, changing more than one bit of the address could impose a transient wrong address. Therefore, this should only be done while in the memory mode. The Mode Select Function Table summarizes the operations of the MC74AC/ACT259.

# MC74AC259, MC74ACT259

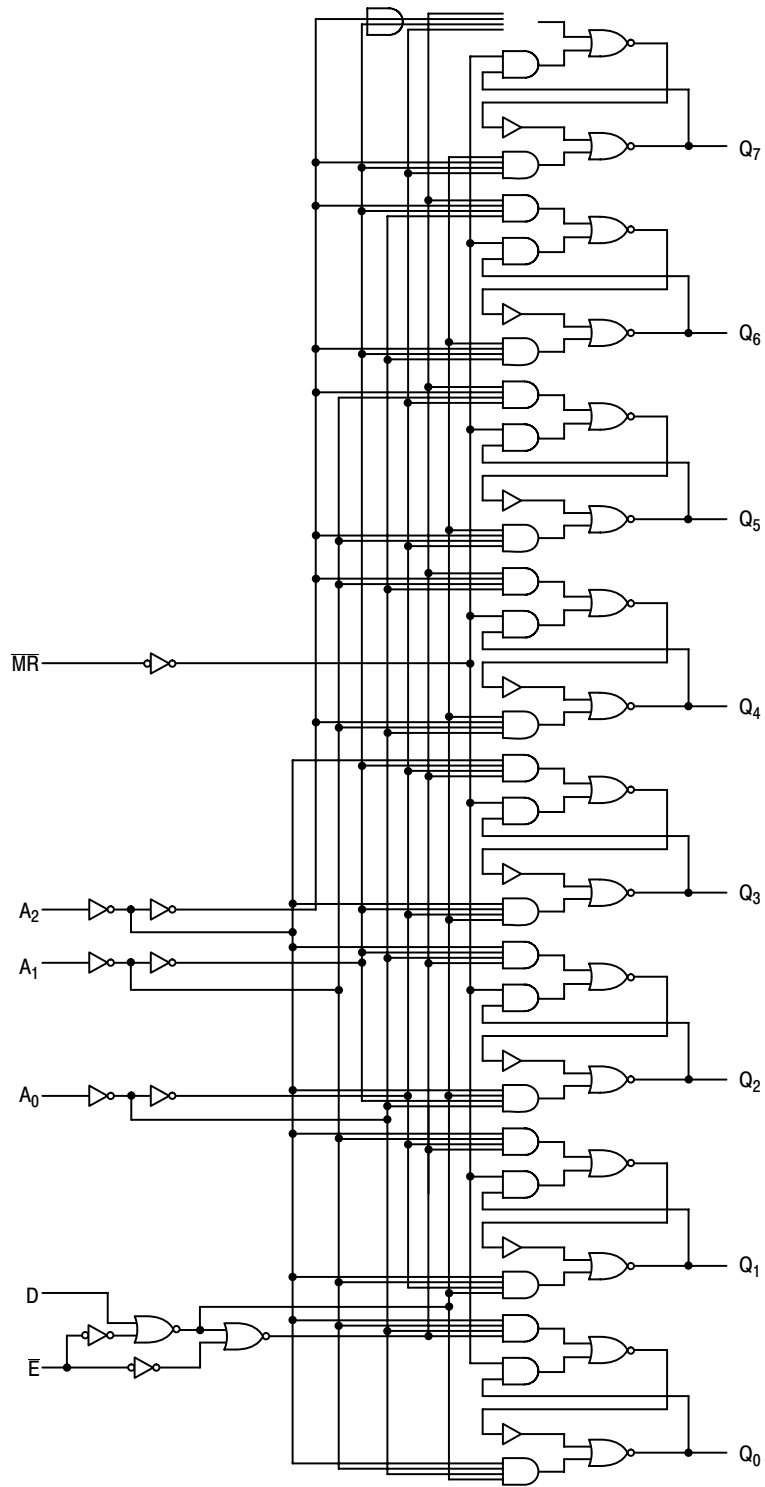

NOTE: This diagram is provided only for the understanding of logic operations and should not be used to estimate propagation delays.

Figure 3. Logic Diagram

# MC74AC259, MC74ACT259

## MAXIMUM RATINGS

| Symbol    | Parameter                                 | Value                  | Unit        |
|-----------|---|------------------------|-------------|
| $V_{CC}$  | DC Supply Voltage (Referenced to GND)     | -0.5 to +7.0           | V           |
| $V_{IN}$  | DC Input Voltage (Referenced to GND)      | -0.5 to $V_{CC} + 0.5$ | V           |
| $V_{OUT}$ | DC Output Voltage (Referenced to GND)     | -0.5 to $V_{CC} + 0.5$ | V           |
| $I_{IN}$  | DC Input Current, per Pin                 | $\pm 20$               | mA          |
| $I_{OUT}$ | DC Output Sink/Source Current, per Pin    | $\pm 50$               | mA          |
| $I_{CC}$  | DC $V_{CC}$ or GND Current per Output Pin | $\pm 50$               | mA          |
| $T_{stg}$ | Storage Temperature                       | -65 to +150            | $^{\circ}C$ |

Maximum ratings are those values beyond which device damage can occur. Maximum ratings applied to the device are individual stress limit values (not normal operating conditions) and are not valid simultaneously. If these limits are exceeded, device functional operation is not implied, damage may occur and reliability may be affected.

## RECOMMENDED OPERATING CONDITIONS

| Symbol            | Parameter   | Min              | Typ | Max      | Unit        |      |
|-------------------|---|------------------|-----|----------|-------------|------|
| $V_{CC}$          | Supply Voltage  | 'AC              | 2.0 | 5.0      | 6.0         | V    |
|                   |   | 'ACT             | 4.5 | 5.0      | 5.5         |      |
| $V_{IN}, V_{OUT}$ | DC Input Voltage, Output Voltage (Ref. to GND)                          | 0                | -   | $V_{CC}$ | V           |      |
| $t_r, t_f$        | Input Rise and Fall Time (Note 1)<br>'AC Devices except Schmitt Inputs  | $V_{CC}$ @ 3.0 V | -   | 150      | -           | ns/V |
|                   |   | $V_{CC}$ @ 4.5 V | -   | 40       | -           |      |
|                   |   | $V_{CC}$ @ 5.5 V | -   | 25       | -           |      |
| $t_r, t_f$        | Input Rise and Fall Time (Note 2)<br>'ACT Devices except Schmitt Inputs | $V_{CC}$ @ 4.5 V | -   | 10       | -           | ns/V |
|                   |   | $V_{CC}$ @ 5.5 V | -   | 8.0      | -           |      |
| $T_J$             | Junction Temperature (PDIP)   | -                | -   | 140      | $^{\circ}C$ |      |
| $T_A$             | Operating Ambient Temperature Range                                     | -40              | 25  | 85       | $^{\circ}C$ |      |
| $I_{OH}$          | Output Current – High   | -                | -   | -24      | mA          |      |
| $I_{OL}$          | Output Current – Low  | -                | -   | 24       | mA          |      |

- $V_{IN}$  from 30% to 70%  $V_{CC}$ ; see individual Data Sheets for devices that differ from the typical input rise and fall times.
- $V_{IN}$  from 0.8 V to 2.0 V; see individual Data Sheets for devices that differ from the typical input rise and fall times.

# MC74AC259, MC74ACT259

## DC CHARACTERISTICS

| Symbol           | Parameter                         | V <sub>CC</sub><br>(V) | 74AC                   |                   | 74AC                            |      | Unit | Conditions   |   |
|------------------|-----------------------------------|------------------------|------------------------|-------------------|---------------------------------|------|------|--|---|
|                  |                                   |                        | T <sub>A</sub> = +25°C |                   | T <sub>A</sub> = -40°C to +85°C |      |      |  |   |
|                  |                                   |                        | Typ                    | Guaranteed Limits |                                 |      |      |  |   |
| V <sub>IH</sub>  | Minimum High Level Input Voltage  | 3.0                    | 1.5                    | 2.1               | 2.1                             |      | V    | V <sub>OUT</sub> = 0.1 V<br>or V <sub>CC</sub> - 0.1 V |   |
|                  |                                   | 4.5                    | 2.25                   | 3.15              | 3.15                            |      |      |  |   |
|                  |                                   | 5.5                    | 2.75                   | 3.85              | 3.85                            |      |      |  |   |
| V <sub>IL</sub>  | Maximum Low Level Input Voltage   | 3.0                    | 1.5                    | 0.9               | 0.9                             |      | V    | V <sub>OUT</sub> = 0.1 V<br>or V <sub>CC</sub> - 0.1 V |   |
|                  |                                   | 4.5                    | 2.25                   | 1.35              | 1.35                            |      |      |  |   |
|                  |                                   | 5.5                    | 2.75                   | 1.65              | 1.65                            |      |      |  |   |
| V <sub>OH</sub>  | Minimum High Level Output Voltage | 3.0                    | 2.99                   | 2.9               | 2.9                             |      | V    | I <sub>OUT</sub> = -50 μA                              |   |
|                  |                                   | 4.5                    | 4.49                   | 4.4               | 4.4                             |      |      |  |   |
|                  |                                   | 5.5                    | 5.49                   | 5.4               | 5.4                             |      |      |  |   |
|                  |                                   |                        | 3.0                    | -                 | 2.56                            | 2.46 |      | V  | *V <sub>IN</sub> = V <sub>IL</sub> or V <sub>IH</sub><br>-12 mA<br>I <sub>OH</sub> = -24 mA<br>-24 mA |
|                  |                                   |                        | 4.5                    | -                 | 3.86                            | 3.76 |      |  |   |
|                  |                                   |                        | 5.5                    | -                 | 4.86                            | 4.76 |      |  |   |
| V <sub>OL</sub>  | Maximum Low Level Output Voltage  | 3.0                    | 0.002                  | 0.1               | 0.1                             |      | V    | I <sub>OUT</sub> = 50 μA                               |   |
|                  |                                   | 4.5                    | 0.001                  | 0.1               | 0.1                             |      |      |  |   |
|                  |                                   | 5.5                    | 0.001                  | 0.1               | 0.1                             |      |      |  |   |
|                  |                                   |                        | 3.0                    | -                 | 0.36                            | 0.44 |      | V  | *V <sub>IN</sub> = V <sub>IL</sub> or V <sub>IH</sub><br>12 mA<br>I <sub>OL</sub> = 24 mA<br>24 mA    |
|                  |                                   |                        | 4.5                    | -                 | 0.36                            | 0.44 |      |  |   |
|                  |                                   |                        | 5.5                    | -                 | 0.36                            | 0.44 |      |  |   |
| I <sub>IN</sub>  | Maximum Input Leakage Current     | 5.5                    | -                      | ±0.1              | ±1.0                            |      | μA   | V <sub>I</sub> = V <sub>CC</sub> , GND                 |   |
| I <sub>OLD</sub> | †Minimum Dynamic Output Current   | 5.5                    | -                      | -                 | 75                              |      | mA   | V <sub>OLD</sub> = 1.65 V Max                          |   |
| I <sub>OHD</sub> |                                   | 5.5                    | -                      | -                 | -75                             |      | mA   | V <sub>OHD</sub> = 3.85 V Min                          |   |
| I <sub>CC</sub>  | Maximum Quiescent Supply Current  | 5.5                    | -                      | 8.0               | 80                              |      | μA   | V <sub>IN</sub> = V <sub>CC</sub> or GND               |   |

\*All outputs loaded; thresholds on input associated with output under test.

†Maximum test duration 2.0 ms, one output loaded at a time.

NOTE: I<sub>IN</sub> and I<sub>CC</sub> @ 3.0 V are guaranteed to be less than or equal to the respective limit @ 5.5 V V<sub>CC</sub>.

# MC74AC259, MC74ACT259

**AC CHARACTERISTICS** (For Figures and Waveforms – See Section 3 of the ON Semiconductor FACT Data Book, DL138/D)

| Symbol           | Parameter   | V <sub>CC</sub> *<br>(V) | 74AC   |             |              | 74AC   |              | Unit | Fig. No. |
|------------------|---|--------------------------|--|-------------|--------------|--|--------------|------|----------|
|                  |   |                          | T <sub>A</sub> = +25°C<br>C <sub>L</sub> = 50 pF |             |              | T <sub>A</sub> = -40°C<br>to +85°C<br>C <sub>L</sub> = 50 pF |              |      |          |
|                  |   |                          | Min  | Typ         | Max          | Min  | Max          |      |          |
| t <sub>PLH</sub> | Propagation Delay<br>D <sub>n</sub> to Q <sub>n</sub> | 3.3<br>5.0               | 2.0<br>2.0                                       | 9.0<br>6.5  | 14.5<br>10.0 | 1.5<br>1.5   | 17.0<br>11.5 | ns   | 3-5      |
| t <sub>PHL</sub> | Propagation Delay<br>D <sub>n</sub> to Q <sub>n</sub> | 3.3<br>5.0               | 2.0<br>2.0                                       | 9.0<br>6.0  | 13.5<br>9.5  | 1.5<br>1.5   | 16.0<br>11.0 | ns   | 3-5      |
| t <sub>PLH</sub> | Propagation Delay<br>E to Q <sub>n</sub>              | 3.3<br>5.0               | 2.0<br>2.0                                       | 10.5<br>7.0 | 15.0<br>10.5 | 1.5<br>1.5   | 17.5<br>12.5 | ns   | 3-6      |
| t <sub>PHL</sub> | Propagation Delay<br>E to Q <sub>n</sub>              | 3.3<br>5.0               | 2.0<br>2.0                                       | 8.0<br>7.5  | 12.5<br>9.0  | 1.5<br>1.5   | 15.0<br>11.0 | ns   | 3-6      |
| t <sub>PLH</sub> | Propagation Delay<br>Address to Q <sub>n</sub>        | 3.3<br>5.0               | 2.0<br>2.0                                       | 12.0<br>8.0 | 19.0<br>13.0 | 1.5<br>1.5   | 22.5<br>15.5 | ns   | 3-6      |
| t <sub>PHL</sub> | Propagation Delay<br>Address to Q <sub>n</sub>        | 3.3<br>5.0               | 2.0<br>2.0                                       | 10.0<br>7.0 | 16.0<br>11.0 | 1.5<br>1.5   | 19.0<br>13.0 | ns   | 3-6      |
| t <sub>PHL</sub> | Propagation Delay<br>$\overline{MR}$ to Q             | 3.3<br>5.0               | 2.0<br>2.0                                       | 8.0<br>6.0  | 12.0<br>9.0  | 1.5<br>1.5   | 13.5<br>10.0 | ns   | 3-7      |

\*Voltage Range 3.3 V is 3.3 V ±0.3 V.

\*Voltage Range 5.0 V is 5.0 V ±0.5 V.

## AC OPERATING REQUIREMENTS

| Symbol         | Parameter   | V <sub>CC</sub> *<br>(V) | 74AC   |                    | 74AC  |  | Unit | Fig. No. |
|----------------|---|--------------------------|--|--------------------|---|--|------|----------|
|                |   |                          | T <sub>A</sub> = +25°C<br>C <sub>L</sub> = 50 pF |                    | T <sub>A</sub> = -40°C to +85°C<br>C <sub>L</sub> = 50 pF |  |      |          |
|                |   |                          | Typ  | Guaranteed Minimum |   |  |      |          |
| t <sub>s</sub> | Setup Time, HIGH or LOW<br>D <sub>n</sub> to $\overline{E}$ | 3.3<br>5.0               | –<br>–   | 3.5<br>2.5         | 4.5<br>3.5  |  | ns   | 3-9      |
| t <sub>h</sub> | Hold Time, HIGH or LOW<br>D <sub>n</sub> to $\overline{E}$  | 3.3<br>5.0               | –<br>–   | 2.5<br>2.0         | 2.5<br>2.0  |  | ns   | 3-9      |
| t <sub>s</sub> | Setup Time<br>Address to $\overline{E}$                     | 3.3<br>5.0               | –<br>–   | 7.0<br>4.0         | 9.0<br>6.0  |  | ns   | 3-6      |
| t <sub>h</sub> | Hold Time<br>Address to $\overline{E}$                      | 3.3<br>5.0               | –<br>–   | 2.0<br>2.0         | 2.0<br>2.0  |  | ns   | 3-6      |
| t <sub>w</sub> | Minimum Pulse<br>Width $\overline{MR}$                      | 3.3<br>5.0               | –<br>–   | 6.0<br>5.5         | 6.5<br>6.0  |  | ns   | 3-6      |
| t <sub>w</sub> | Minimum Pulse<br>Width $\overline{E}$                       | 3.3<br>5.0               | –<br>–   | 6.5<br>5.5         | 7.0<br>6.0  |  | ns   | 3-6      |

\*Voltage Range 3.3 V is 3.3 V ±0.3 V.

\*Voltage Range 5.0 V is 5.0 V ±0.5 V.

# MC74AC259, MC74ACT259

## DC CHARACTERISTICS

| Symbol            | Parameter                              | V <sub>CC</sub><br>(V) | 74ACT                  |                   | 74ACT                           |  | Unit | Conditions  |
|-------------------|--|------------------------|------------------------|-------------------|---------------------------------|--|------|---|
|                   |  |                        | T <sub>A</sub> = +25°C |                   | T <sub>A</sub> = -40°C to +85°C |  |      |   |
|                   |  |                        | Typ                    | Guaranteed Limits |                                 |  |      |   |
| V <sub>IH</sub>   | Minimum High Level Input Voltage       | 4.5                    | 1.5                    | 2.0               | 2.0                             |  | V    | V <sub>OUT</sub> = 0.1 V<br>or V <sub>CC</sub> - 0.1 V                                    |
|                   |  | 5.5                    | 1.5                    | 2.0               | 2.0                             |  |      |   |
| V <sub>IL</sub>   | Maximum Low Level Input Voltage        | 4.5                    | 1.5                    | 0.8               | 0.8                             |  | V    | V <sub>OUT</sub> = 0.1 V<br>or V <sub>CC</sub> - 0.1 V                                    |
|                   |  | 5.5                    | 1.5                    | 0.8               | 0.8                             |  |      |   |
| V <sub>OH</sub>   | Minimum High Level Output Voltage      | 4.5                    | 4.49                   | 4.4               | 4.4                             |  | V    | I <sub>OUT</sub> = -50 μA   |
|                   |  | 5.5                    | 5.49                   | 5.4               | 5.4                             |  |      |   |
|                   |  | 4.5                    | -                      | 3.86              | 3.76                            |  | V    | *V <sub>IN</sub> = V <sub>IL</sub> or V <sub>IH</sub><br>-24 mA<br>I <sub>OH</sub> -24 mA |
|                   |  | 5.5                    | -                      | 4.86              | 4.76                            |  |      |   |
| V <sub>OL</sub>   | Maximum Low Level Output Voltage       | 4.5                    | 0.001                  | 0.1               | 0.1                             |  | V    | I <sub>OUT</sub> = 50 μA  |
|                   |  | 5.5                    | 0.001                  | 0.1               | 0.1                             |  |      |   |
|                   |  | 4.5                    | -                      | 0.36              | 0.44                            |  | V    | *V <sub>IN</sub> = V <sub>IL</sub> or V <sub>IH</sub><br>24 mA<br>I <sub>OL</sub> 24 mA   |
|                   |  | 5.5                    | -                      | 0.36              | 0.44                            |  |      |   |
| I <sub>IN</sub>   | Maximum Input Leakage Current          | 5.5                    | -                      | ±0.1              | ±1.0                            |  | μA   | V <sub>I</sub> = V <sub>CC</sub> , GND  |
| ΔI <sub>CCT</sub> | Additional Max. I <sub>CC</sub> /Input | 5.5                    | 0.6                    | -                 | 1.5                             |  | mA   | V <sub>I</sub> = V <sub>CC</sub> - 2.1 V  |
| I <sub>OLD</sub>  | †Minimum Dynamic Output Current        | 5.5                    | -                      | -                 | 75                              |  | mA   | V <sub>OLD</sub> = 1.65 V Max   |
| I <sub>OHD</sub>  |  | 5.5                    | -                      | -                 | -75                             |  | mA   | V <sub>OHD</sub> = 3.85 V Min   |
| I <sub>CC</sub>   | Maximum Quiescent Supply Current       | 5.5                    | -                      | 8.0               | 80                              |  | μA   | V <sub>IN</sub> = V <sub>CC</sub> or GND  |

\*All outputs loaded; thresholds on input associated with output under test.

†Maximum test duration 2.0 ms, one output loaded at a time.

## AC CHARACTERISTICS (For Figures and Waveforms – See Section 3 of the ON Semiconductor FACT Data Book, DL138/D)

| Symbol           | Parameter   | V <sub>CC</sub> *<br>(V) | 74ACT  |      |      | 74ACT   |      | Unit | Fig. No. |
|------------------|---|--------------------------|--|------|------|---|------|------|----------|
|                  |   |                          | T <sub>A</sub> = +25°C<br>C <sub>L</sub> = 50 pF |      |      | T <sub>A</sub> = -40°C to +85°C<br>C <sub>L</sub> = 50 pF |      |      |          |
|                  |   |                          | Min  | Typ  | Max  | Min   | Max  |      |          |
| t <sub>PLH</sub> | Propagation Delay<br>D <sub>n</sub> to Q <sub>n</sub> | 5.0                      | 2.0  | 6.5  | 11.0 | 1.5   | 12.5 | ns   | 3-5      |
| t <sub>PHL</sub> | Propagation Delay<br>D <sub>n</sub> or Q <sub>n</sub> | 5.0                      | 2.0  | 7.0  | 10.5 | 1.5   | 12.0 | ns   | 3-5      |
| t <sub>PLH</sub> | Propagation Delay<br>E to Q <sub>n</sub>              | 5.0                      | 2.0  | 10.5 | 14.0 | 1.5   | 16.5 | ns   | 3-6      |
| t <sub>PHL</sub> | Propagation Delay<br>E or Q <sub>n</sub>              | 5.0                      | 2.0  | 9.0  | 12.0 | 1.5   | 14.0 | ns   | 3-6      |
| t <sub>PLH</sub> | Propagation Delay<br>Address to Q <sub>n</sub>        | 5.0                      | 2.0  | 8.0  | 11.5 | 1.5   | 13.5 | ns   | 3-6      |
| t <sub>PHL</sub> | Propagation Delay<br>Address to Q <sub>n</sub>        | 5.0                      | 2.0  | 6.0  | 10.0 | 1.5   | 12.0 | ns   | 3-6      |
| t <sub>PHL</sub> | Propagation Delay<br>MR to Q                          | 5.0                      | 2.0  |      | 10.0 | 1.5   | 11.0 | ns   | 3-7      |

\*Voltage Range 5.0 V is 5.0 V ±0.5 V.

# MC74AC259, MC74ACT259

## AC OPERATING REQUIREMENTS

| Symbol         | Parameter  | V <sub>CC</sub> *<br>(V) | 74ACT  |                    | 74ACT   |    | Unit | Fig. No. |
|----------------|--|--------------------------|--|--------------------|---|----|------|----------|
|                |  |                          | T <sub>A</sub> = +25°C<br>C <sub>L</sub> = 50 pF |                    | T <sub>A</sub> = -40°C to +85°C<br>C <sub>L</sub> = 50 pF |    |      |          |
|                |  |                          | Typ  | Guaranteed Minimum |   |    |      |          |
| t <sub>s</sub> | Setup Time, HIGH or LOW<br>D <sub>n</sub> to $\bar{E}$ | 5.0                      | -  | 3.0                | 4.0   | ns | 3-9  |          |
| t <sub>h</sub> | Hold Time, HIGH or LOW<br>D <sub>n</sub> to $\bar{E}$  | 5.0                      | -  | 2.5                | 2.5   | ns | 3-9  |          |
| t <sub>s</sub> | Setup Time<br>Address to $\bar{E}$                     | 5.0                      | -  | 4.5                | 6.5   | ns | 3-6  |          |
| t <sub>h</sub> | Hold Time<br>Address to $\bar{E}$                      | 5.0                      | -  | 2.5                | 2.5   | ns | 3-6  |          |
| t <sub>w</sub> | Minimum Pulse<br>Width $\bar{M}\bar{R}$                | 5.0                      | -  | 7.0                | 7.5   | ns | 3-6  |          |
| t <sub>w</sub> | Minimum Pulse<br>Width $\bar{E}$                       | 5.0                      | -  | 7.0                | 7.5   | ns | 3-6  |          |

\*Voltage Range 5.0 V is 5.0 V ±0.5 V.

## CAPACITANCE

| Symbol          | Parameter                     | Value<br>Typ | Unit | Test Conditions         |
|-----------------|-------------------------------|--------------|------|-------------------------|
| C <sub>IN</sub> | Input Capacitance             | 4.5          | pF   | V <sub>CC</sub> = 5.0 V |
| C <sub>PD</sub> | Power Dissipation Capacitance | 50.0         | pF   | V <sub>CC</sub> = 5.0 V |



# MC74AC259, MC74ACT259

## MARKING DIAGRAMS

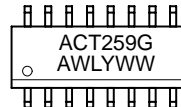
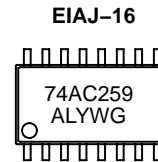
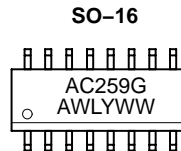
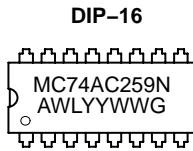

A = Assembly Location  
 WL, L = Wafer Lot  
 YY, Y = Year  
 WW, W = Work Week  
 G = Pb-Free Device

## ORDERING INFORMATION

| Part Number    | Package                | Shipping†        |
|----------------|------------------------|------------------|
| MC74AC259N     | PDIP-16                | 25 Units/Rail    |
| MC74AC259NG    | PDIP-16<br>(Pb-Free)   | 25 Units/Rail    |
| MC74AC259D     | SOIC-16                | 48 Units/Rail    |
| MC74AC259DG    | SOIC-16<br>(Pb-Free)   | 48 Units/Rail    |
| MC74AC259DR2   | SOIC-16                | 2500 Tape & Reel |
| MC74AC259DR2G  | SOIC-16<br>(Pb-Free)   | 2500 Tape & Reel |
| MC74AC259M     | SOEIAJ-16              | 50 Units/Rail    |
| MC74AC259MG    | SOEIAJ-16<br>(Pb-Free) | 50 Units/Rail    |
| MC74AC259MEL   | SOEIAJ-16              | 2000 Tape & Reel |
| MC74AC259MELG  | SOEIAJ-16<br>(Pb-Free) | 2000 Tape & Reel |
| MC74ACT259N    | PDIP-16                | 25 Units/Rail    |
| MC74ACT259NG   | PDIP-16<br>(Pb-Free)   | 25 Units/Rail    |
| MC74ACT259D    | SOIC-16                | 48 Units/Rail    |
| MC74ACT259DG   | SOIC-16<br>(Pb-Free)   | 48 Units/Rail    |
| MC74ACT259DR2  | SOIC-16                | 2500 Tape & Reel |
| MC74ACT259DR2G | SOIC-16<br>(Pb-Free)   | 2500 Tape & Reel |

†For information on tape and reel specifications, including part orientation and tape sizes, please refer to our Tape and Reel Packaging Specifications Brochure, BRD8011/D.

# MC74AC259, MC74ACT259

## PACKAGE DIMENSIONS

### PDIP-16 N SUFFIX CASE 648-08 ISSUE T

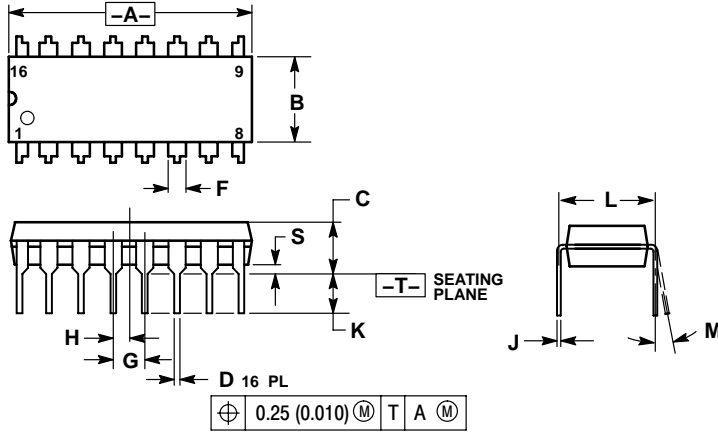

NOTES:

1. DIMENSIONING AND TOLERANCING PER ANSI Y14.5M, 1982.
2. CONTROLLING DIMENSION: INCH.
3. DIMENSION L TO CENTER OF LEADS WHEN FORMED PARALLEL.
4. DIMENSION B DOES NOT INCLUDE MOLD FLASH.
5. ROUNDED CORNERS OPTIONAL.

| DIM | INCHES    |       | MILLIMETERS |       |
|-----|-----------|-------|-------------|-------|
|     | MIN       | MAX   | MIN         | MAX   |
| A   | 0.740     | 0.770 | 18.80       | 19.55 |
| B   | 0.250     | 0.270 | 6.35        | 6.85  |
| C   | 0.145     | 0.175 | 3.69        | 4.44  |
| D   | 0.015     | 0.021 | 0.39        | 0.53  |
| F   | 0.040     | 0.70  | 1.02        | 1.77  |
| G   | 0.100 BSC |       | 2.54 BSC    |       |
| H   | 0.050 BSC |       | 1.27 BSC    |       |
| J   | 0.008     | 0.015 | 0.21        | 0.38  |
| K   | 0.110     | 0.130 | 2.80        | 3.30  |
| L   | 0.295     | 0.305 | 7.50        | 7.74  |
| M   | 0°        | 10°   | 0°          | 10°   |
| S   | 0.020     | 0.040 | 0.51        | 1.01  |

### SOIC-16 D SUFFIX CASE 751B-05 ISSUE J

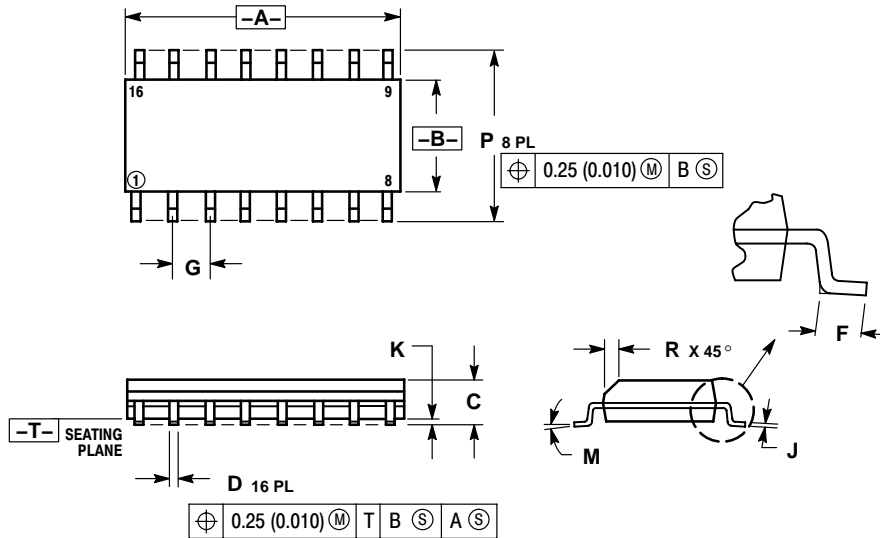

NOTES:

1. DIMENSIONING AND TOLERANCING PER ANSI Y14.5M, 1982.
2. CONTROLLING DIMENSION: MILLIMETER.
3. DIMENSIONS A AND B DO NOT INCLUDE MOLD PROTRUSION.
4. MAXIMUM MOLD PROTRUSION 0.15 (0.006) PER SIDE.
5. DIMENSION D DOES NOT INCLUDE DAMBAR PROTRUSION. ALLOWABLE DAMBAR PROTRUSION SHALL BE 0.127 (0.005) TOTAL IN EXCESS OF THE D DIMENSION AT MAXIMUM MATERIAL CONDITION.

| DIM | MILLIMETERS |       | INCHES    |       |
|-----|-------------|-------|-----------|-------|
|     | MIN         | MAX   | MIN       | MAX   |
| A   | 9.80        | 10.00 | 0.386     | 0.393 |
| B   | 3.80        | 4.00  | 0.150     | 0.157 |
| C   | 1.35        | 1.75  | 0.054     | 0.068 |
| D   | 0.35        | 0.49  | 0.014     | 0.019 |
| F   | 0.40        | 1.25  | 0.016     | 0.049 |
| G   | 1.27 BSC    |       | 0.050 BSC |       |
| J   | 0.19        | 0.25  | 0.008     | 0.009 |
| K   | 0.10        | 0.25  | 0.004     | 0.009 |
| M   | 0°          | 7°    | 0°        | 7°    |
| P   | 5.80        | 6.20  | 0.229     | 0.244 |
| R   | 0.25        | 0.50  | 0.010     | 0.019 |

# MC74AC259, MC74ACT259

## PACKAGE DIMENSIONS

SOEIAJ-16  
M SUFFIX  
CASE966-01  
ISSUE A

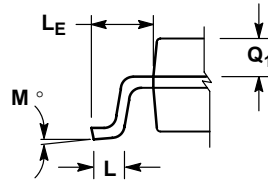
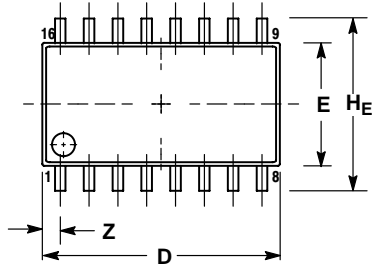

DETAIL P

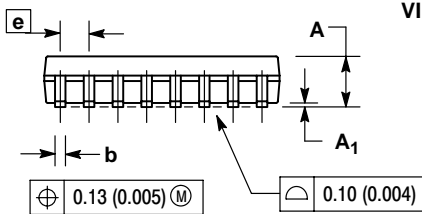

VIEW P

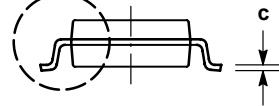

NOTES:

1. DIMENSIONING AND TOLERANCING PER ANSI Y14.5M, 1982.
2. CONTROLLING DIMENSION: MILLIMETER.
3. DIMENSIONS D AND E DO NOT INCLUDE MOLD FLASH OR PROTRUSIONS AND ARE MEASURED AT THE PARTING LINE. MOLD FLASH OR PROTRUSIONS SHALL NOT EXCEED 0.15 (0.006) PER SIDE.
4. TERMINAL NUMBERS ARE SHOWN FOR REFERENCE ONLY.
5. THE LEAD WIDTH DIMENSION (b) DOES NOT INCLUDE DAMBAR PROTRUSION. ALLOWABLE DAMBAR PROTRUSION SHALL BE 0.08 (0.003) TOTAL IN EXCESS OF THE LEAD WIDTH DIMENSION AT MAXIMUM MATERIAL CONDITION. DAMBAR CANNOT BE LOCATED ON THE LOWER RADIUS OR THE FOOT. MINIMUM SPACE BETWEEN PROTRUSIONS AND ADJACENT LEAD TO BE 0.46 (0.018).

| DIM            | MILLIMETERS |       | INCHES    |       |
|----------------|-------------|-------|-----------|-------|
|                | MIN         | MAX   | MIN       | MAX   |
| A              | ---         | 2.05  | ---       | 0.081 |
| A <sub>1</sub> | 0.05        | 0.20  | 0.002     | 0.008 |
| b              | 0.35        | 0.50  | 0.014     | 0.020 |
| c              | 0.10        | 0.20  | 0.007     | 0.011 |
| D              | 9.90        | 10.50 | 0.390     | 0.413 |
| E              | 5.10        | 5.45  | 0.201     | 0.215 |
| e              | 1.27 BSC    |       | 0.050 BSC |       |
| H <sub>E</sub> | 7.40        | 8.20  | 0.291     | 0.323 |
| L              | 0.50        | 0.85  | 0.020     | 0.033 |
| L <sub>E</sub> | 1.10        | 1.50  | 0.043     | 0.059 |
| M              | 0°          | 10°   | 0°        | 10°   |
| Q <sub>1</sub> | 0.70        | 0.90  | 0.028     | 0.035 |
| Z              | ---         | 0.78  | ---       | 0.031 |

ON Semiconductor and are registered trademarks of Semiconductor Components Industries, LLC (SCILLC). SCILLC reserves the right to make changes without further notice to any products herein. SCILLC makes no warranty, representation or guarantee regarding the suitability of its products for any particular purpose, nor does SCILLC assume any liability arising out of the application or use of any product or circuit, and specifically disclaims any and all liability, including without limitation special, consequential or incidental damages. "Typical" parameters which may be provided in SCILLC data sheets and/or specifications can and do vary in different applications and actual performance may vary over time. All operating parameters, including "Typicals" must be validated for each customer application by customer's technical experts. SCILLC does not convey any license under its patent rights nor the rights of others. SCILLC products are not designed, intended, or authorized for use as components in systems intended for surgical implant into the body, or other applications intended to support or sustain life, or for any other application in which the failure of the SCILLC product could create a situation where personal injury or death may occur. Should Buyer purchase or use SCILLC products for any such unintended or unauthorized application, Buyer shall indemnify and hold SCILLC and its officers, employees, subsidiaries, affiliates, and distributors harmless against all claims, costs, damages, and expenses, and reasonable attorney fees arising out of, directly or indirectly, any claim of personal injury or death associated with such unintended or unauthorized use, even if such claim alleges that SCILLC was negligent regarding the design or manufacture of the part. SCILLC is an Equal Opportunity/Affirmative Action Employer. This literature is subject to all applicable copyright laws and is not for resale in any manner.

### PUBLICATION ORDERING INFORMATION

**LITERATURE FULFILLMENT:**  
Literature Distribution Center for ON Semiconductor  
P.O. Box 61312, Phoenix, Arizona 85082-1312 USA  
**Phone:** 480-829-7710 or 800-344-3860 Toll Free USA/Canada  
**Fax:** 480-829-7709 or 800-344-3867 Toll Free USA/Canada  
**Email:** orderlit@onsemi.com

**N. American Technical Support:** 800-282-9855 Toll Free  
USA/Canada

**Japan:** ON Semiconductor, Japan Customer Focus Center  
2-9-1 Kamimeguro, Meguro-ku, Tokyo, Japan 153-0051  
**Phone:** 81-3-5773-3850

**ON Semiconductor Website:** <http://onsemi.com>

**Order Literature:** <http://www.onsemi.com/litorder>

For additional information, please contact your local Sales Representative.