

## FLLD3130AMHT6

Aliases (LLD3130AMHT6)

KEMET, FLLD3-MH, EMI/RFI Filters, Noise Suppression, 530 VAC, 130 A, 240x90x150mm

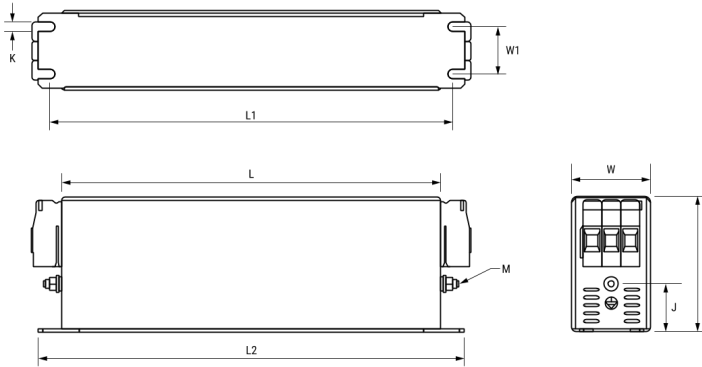

Click [here](#) for the 3D model.

### Dimensions

L	240mm NOM
W	90mm NOM
H	150mm NOM
L1	255mm NOM
L2	270mm NOM
W1	65mm NOM
J	64mm NOM
K	6.5mm NOM
M (Earth)	Threaded Studs M10

### Packaging Specifications

Packaging	Bulk
Packaging Quantity	1
Component Weight	4500 g

### General Information

Series	FLLD3-MH
Style	Chassis Mount
Description	EMI Filter, Chassis Mount, Motor Drives
Features	Three Phase, High Performance, High Voltage
Phase	Three-phase
RoHS	Yes
Qualifications	IEC/EN 60939, UL 1283
Terminal Type	Threaded Studs M10

### Specifications

Voltage AC	530 VAC, 305 VAC
Rated Frequency	50-60 Hz
Rated Current	130 A (50°C)
Rated Temperature	50°C
Temperature Range	-25/+100°C
Climate Category	25/100/21
Test Voltage DC (P to P)	2250 VDC
Test Voltage DC (P to E)	3000 VDC
Power Loss	40 W (25°C 50 Hz)
Leakage Current	4.7 mA