

APPROVAL SHEET

WLPH252010_S Series (High Current) SMD Molded Power Inductor



*Contents in this sheet are subject to change without prior notice.

Features

1. High saturation current realized by material properties and structure design
2. Low DC resistance to achieve high conversion efficiency and lower temperature rising
3. Low Profile: 2.5 mm × 2.0 mm × 1.0 mm.
4. Magnetically shielded structure to accomplish high resolution in EMC protection.
5. Halogen free, Lead Free, RoHS Compliance.

Applications

1. WLPH Series is generic applied in portable DC to DC converter line.
2. Smart phone, PAD applications high current and low profile power supplier.
3. DC/DC converter
4. Thin-type power supply module,

Shape and Dimension

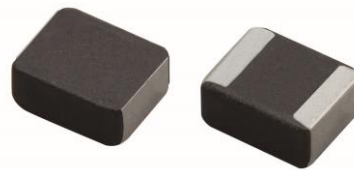
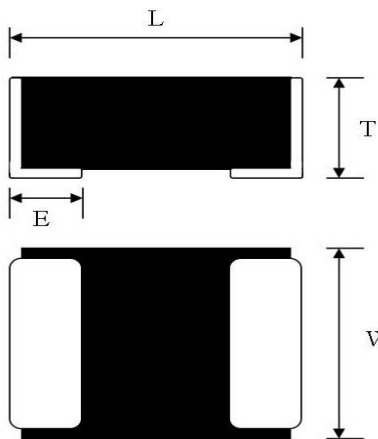

Code	Dimensions(mm)
L	2.5 ± 0.2
W	2.0 ± 0.2
T	1.0 MAX.
e	0.6 ± 0.3

Recommend Pattern

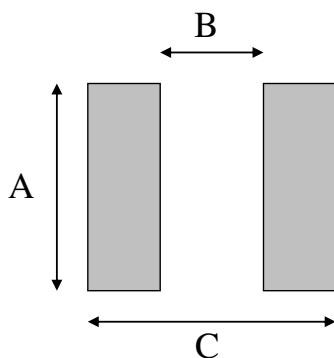

A [mm]	B [mm]	C [mm]
2.0	1.2	2.8

(Unit: mm)

Ordering Information

WL	PH	2520	10	M	R24	P	S
Product Code	Series	Dimensions	Thickness	Tolerance	Value	Packing Code	
WL: Inductor	SMD molded power inductor.	2.5 * 2.0mm	1.0mm	M: ± 20%	R24=0.24uH 2R2=2.20uH	P=7" Reeled (Embossed tape)	S:High Current

Electrical Characteristics

WLPH252010_S series

Walsin Part Number	L(uH) Inductance	Tolerance (±%)	RDC DC Resistance (mΩ)	Isat[A] Saturation Current		Irms[A] Heat Rating Current	
			(Typ) Max	Typ	Max	Typ	Max
WLPH252010MR33PS	0.33	20	(17) 22	7.8	7.0	5.6	4.8
WLPH252010MR47PS	0.47	20	(23) 29	6.6	6.0	5.2	4.4
WLPH252010MR68PS	0.68	20	(30) 36	5.5	5.0	4.3	3.7
WLPH252010M1R0PS	1.0	20	(41) 52	4.4	4.0	3.4	3.1
WLPH252010M2R2PS	2.2	20	(88) 110	3.3	3.0	2.4	2.1
WLPH252010M4R7PS	4.7	20	(200) 240	2.2	1.9	1.6	1.4

1: Customized design is available, please contact us.

2: All test referenced to 26°C ambient

3: Inductance tolerance +/- 20%

4: Inductance is measured with Agilent® LCR meter 4285A (or equivalent) at 1MHz/1V.

5: DC resistance is measured with HIOKI® micro-ohm meter RM3542 or equivalent.

6: Isat means that DC current will cause a 30% inductance reduction from initial value.

7: Irms means that DC current will cause coil temp. rising to 40°C whichever is smaller.

Temperature Specifications

Operating Temperature range : -40°C to +125°C

Storage Temperature range : -50°C to +125°C

Current Characteristic

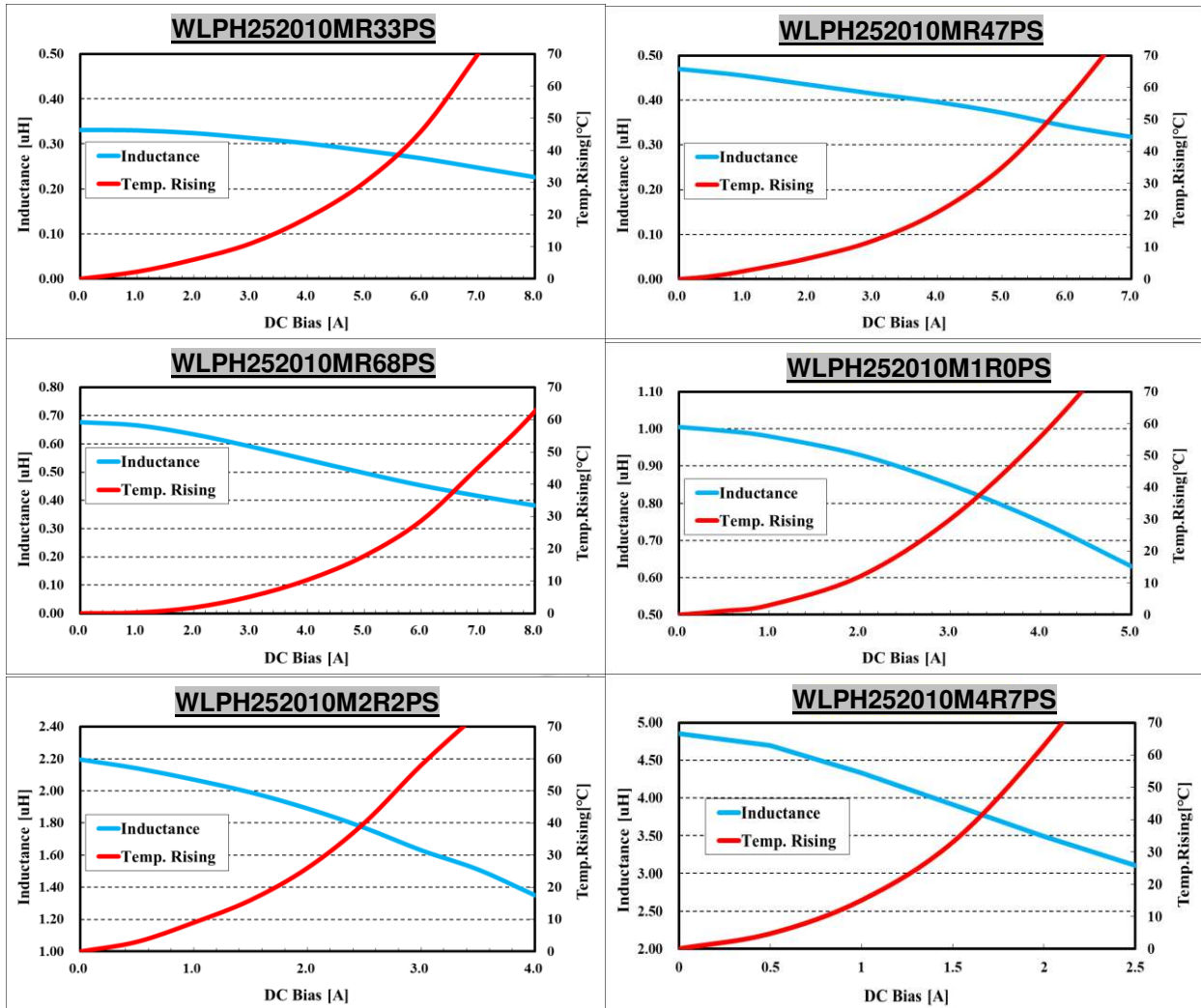

Reliability and Test Condition

Test item	Test condition	Criteria
Resistance to Solder Heat	<ol style="list-style-type: none"> 1. Solder temperature : $260 \pm 5^{\circ}\text{C}$ 2. Flux : Rosin 3. DIP time : 10 ± 1 sec 	<ol style="list-style-type: none"> 1. More than 95 % of terminal electrode should be covered with new solder 2. No mechanical damage 3. Inductance value should be within ± 20 % of the initial value
Adhesive Test	<ol style="list-style-type: none"> 1. Reflow temperature : 245°C It shall be Soldered on the substrate applying direction parallel to the substrate 2. Apply force(F) : 5 N 3. Test time : 10 sec 	<ol style="list-style-type: none"> 1. No mechanical damage 2. Soldering the products on PCB after the pulling test force > 5 N
Temperature Cycle	<ol style="list-style-type: none"> 1. Temperature: $-50 \sim 125^{\circ}\text{C}$ For 30 minutes each 2. Cycle: 500 cycles 3. Measurement: At ambient temperature 24 hours after test completion 	<ol style="list-style-type: none"> 1. No mechanical damage 2. Inductance should be within $\pm 20\%$ of the initial value
Dry Heat Test	<ol style="list-style-type: none"> 1. Temperature: $85 \pm 2^{\circ}\text{C}$ 2. Testing time: 500 hours 3. Applied current: Full rated current 4. Measurement: At ambient temperature 24 hours after test completion 	<ol style="list-style-type: none"> 1. No mechanical damage 2. Inductance should be within $\pm 20\%$ of the initial value
Humidity Test	<ol style="list-style-type: none"> 1. Temperature: $60 \pm 2^{\circ}\text{C}$ 2. Humidity: 90-95 % RH 3. Applied current: Full rated current 4. Testing time: 500 hours 5. Measurement: At ambient temperature 24 hours after test completion 	<ol style="list-style-type: none"> 1. No mechanical damage 2. Inductance should be within $\pm 20\%$ of the initial value

Taping Package and Label Marking

Carrier tape dimensions

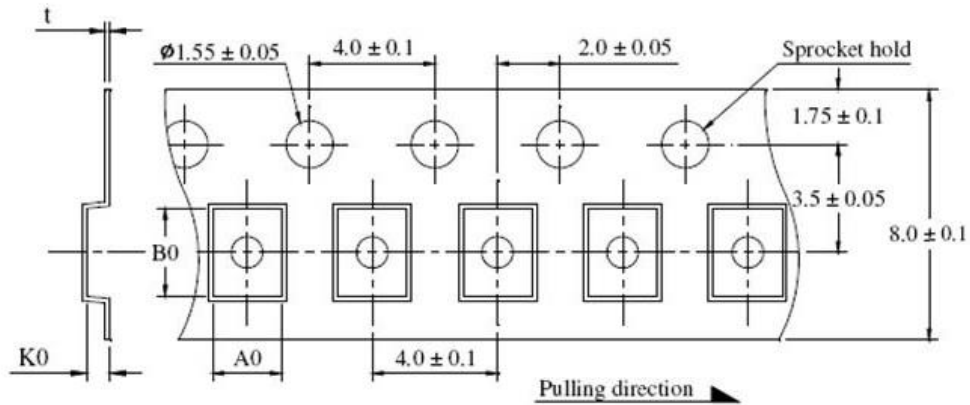

	A0	B0	K0	t
mm	2.25 ± 0.05	2.8 ± 0.1	1.35 ± 0.1	0.22 ± 0.05

Taping reel dimensions

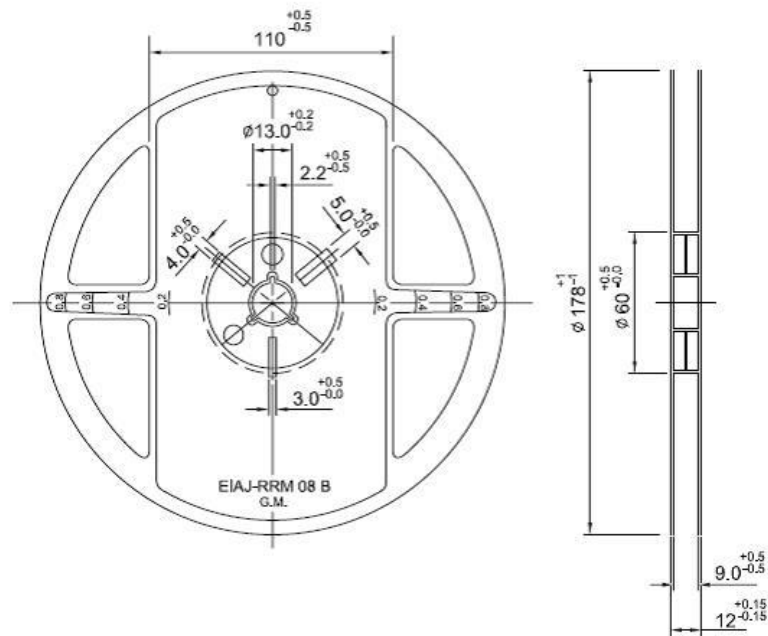

PART SIZE (EIA SIZE)	2520(1008)
Qty.(pcs)	3,000
BOX	5 reels / inner box

Taping specifications

There shall be the portion having no product in both the head and the end of taping, and there shall be the cover tape in the head of taping.

Label Marking

The label specified as follows shall be put on the side of reel.

- (1) Part No
- (2) Quantity
- (3) Lot No

* Part No. And Quantity shall be marked on outer packaging.

Quantity of products in the taping package

- (1) Standard quantity : 3000pcs/Reel
- (2) Shipping quantity is a multiple of standard quantity.

Precautions for Handling

Precaution for handling of substrate

Do not exceed to bend the board after soldering this product extremely. (reference examples)

- Mounting place must be as far as possible from the position, which is close to the break line of board, or on the line of large holes of board.
- Do not bend extremely the board, in mounting another components.
If necessary, use back-up pin (support pin) to prevent from bending extremely.
- Do not break the board by hand. We recommend to use the machine or the jig to break it.

Precaution for soldering

Note that this product will be easily damaged by rapid heating, rapid cooling or local heating. Do not give heat shock over 100°C in the process of soldering. We recommend to take preheating and gradual cooling.

Recommendable reflow soldering

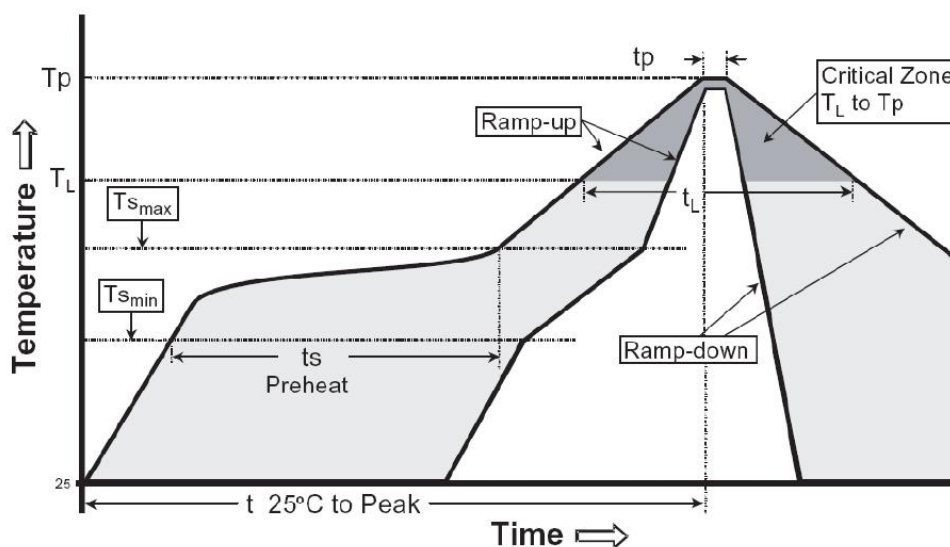

Reference IPC-020c-5-1

Profile Feature	Pb free Assembly
Average Ramp Rate (Ts max to Tp)	3 °C/second max
Preheat	
- Temperature Min (Ts _{min})	150°C
- Temperature Min (Ts _{max})	200°C
- Time(ts _{min} to ts _{min})	60-180 seconds
Time maintained above:	
- Temperature (TL)	217°C
- Time (tL)	60-150 seconds
Peak Temperature (Tp)	260°C +0/-5 °C
Time within 5 °C of actual Peak Temperature (Tp)	20-40 seconds
Ramp-Down Rate	6 °C/second max.
Time 25°C to Peak Temperature	8 minutes max

Soldering gun procedure

Note the follows, in case of using solder gun for replacement.

- (1)The tip temperature must be less than 280°C for the period within 3 seconds by using soldering gun under 30 W.
- (2)The soldering gun tip shall not touch this product directly.

Soldering volume

Note that excess of soldering volume will easily get crack the body of this product.

Taping Package Storage Condition

Storage Temperature : 5 to 40 °C
Relative Humidity: < 65%RH
Storage Time : 12 months max.

