

AIMB-764

Socket LGA 775

Intel Core 2 Duo processor / Intel Pentium D / Pentium 4 / Celeron D

1066 MHz FSB

Industrial ATX Motherboard
with PCIe/DDR2/Dual GbE

User Manual

Copyright

This document is copyrighted, 2007, by Advantech Co., Ltd. All rights are reserved. Advantech Co., Ltd. reserves the right to make improvements to the products described in this manual at any time without notice.

No part of this manual may be reproduced, copied, translated or transmitted in any form or by any means without the prior written permission of Advantech Co., Ltd. Information provided in this manual is intended to be accurate and reliable. However, Advantech Co., Ltd. assumes no responsibility for its use, nor for any infringements upon the rights of third parties which may result from its use.

Acknowledgements

- AWARD is a trademark of Phoenix Technologies Ltd.
- IBM and PC are trademarks of International Business Machines Corporation.
- Intel, Core 2 Duo, Pentium 4, and Celeron D are trademarks of Intel Corporation.
- WinBond is a trademark of Winbond Corporation.
- All other product names or trademarks are the properties of their respective owners.

Part No. 2002076401 2nd Edition
Printed in Taiwan October 2007

A Message to the Customer

Advantech Customer Services

Each and every Advantech product is built to the most exacting specifications to ensure reliable performance in the harsh and demanding conditions typical of industrial environments. Whether your new Advantech equipment is destined for the laboratory or the factory floor, you can be assured that your product will provide the reliability and ease of operation for which the name Advantech has come to be known.

Your satisfaction is our primary concern. Here is a guide to Advantech's customer services. To ensure you get the full benefit of our services, please follow the instructions below carefully.

Technical Support

We want you to get the maximum performance from your products. So if you run into technical difficulties, we are here to help. For the most frequently asked questions, you can easily find answers in your product documentation. These answers are normally a lot more detailed than the ones we can give over the phone.

So please consult this manual first. If you still cannot find the answer, gather all the information or questions that apply to your problem, and with the product close at hand, call your dealer. Our dealers are well trained and ready to give you the support you need to get the most from your Advantech products. In fact, most problems reported are minor and are able to be easily solved over the phone.

In addition, free technical support is available from Advantech engineers every business day. We are always ready to give advice on application requirements or specific information on the installation and operation of any of our products.

Certifications

FCC

This device complies with the requirements in part 15 of the FCC rules: Operation is subject to the following two conditions:

- This device may not cause harmful interference
- This device must accept any interference received, including interference that may cause undesired operation

This equipment has been tested and found to comply with the limits for a Class A digital device, pursuant to Part 15 of the FCC Rules. These limits are designed to provide reasonable protection against harmful interference when the equipment is operated in a commercial environment. This equipment generates, uses, and can radiate radio frequency energy and, if not installed and used in accordance with the instruction manual, may cause harmful interference to radio communications. Operation of this device in a residential area is likely to cause harmful interference in which case the user will be required to correct the interference at his/her own expense. The user is advised that any equipment changes or modifications not expressly approved by the party responsible for compliance would void the compliance to FCC regulations and therefore, the user's authority to operate the equipment.

Caution! *There is a danger of a new battery exploding if it is incorrectly installed. Do not attempt to recharge, force open, or heat the battery. Replace the battery only with the same or equivalent type recommended by the manufacturer. Discard used batteries according to the manufacturer's instructions.*

AIMB-764 Memory Tested for Compatibility

Brand	Size	Speed	Type	Vendor PN	Advantech PN	Memory	Result
Apacer	1GB	DDR2 533	DDR2	78.01066.400	NA	SAMSUNG K4T51083QB-ZKD5 (128x4)	PASS
Transcend	256MB	DDR2 533	DDR2	TS32MLQ 64V5F	NA	SAMSUNG 443 K4T56083QF-GCD5 (32x8)	PASS
DSL	512MB	DDR2 533	DDR2	NA	NA	Infineon HYB18T512 800AF37 FSS43331 (64x8)	PASS
	1GB	DDR2 533	DDR2	NA	NA	ELPIDA E5108AE-5C-E (64x8)	PASS
Apacer (RoHS)	1GB	DDR2 533	DDR2	78.01G66.420	NA	ELPIDA E5108AG-5C-E (64x8)	PASS
	512MB	DDR2 667	DDR2	78.91G92.420	NA	ELPIDA E5108AG-6E-E (64x8)	PASS
	1GB	DDR2 667	DDR2	78.01G92.420	NA	ELPIDA E5108AG-6E-E (64x8)	PASS
Transcend (RoHS)	256MB	DDR2 533	DDR2	TS32MLQ 64V5M	96D2-256M533NN-TR	Infineon HYB18T512 160AF3.7 3VV21710 (32x16)	PASS
	512MB	DDR2 533	DDR2	TS64MLQ 64V5J	96D2-512M533NN-TR1	SEC K4T51083QC (64X8)	PASS
	1GB	DDR2 533	DDR2	TS128ML Q64V5J	96D2-1G533NN-TR1	SEC K4T51083QC (64X8)	PASS
	512MB	DDR2 667	DDR2	TS64MLQ 64V6J	96D2-512M667NN-TR	SEC K4T51083QC ES (64x8)	PASS
	512MB	DDR2 667	DDR2	TS64MLQ 64V6J		SEC K4T51083QC	PASS
	1GB	DDR2 667	DDR2	TS128ML Q64V6J	96D2-1G667NN-TR	5*32 D9DCL	PASS
	2GB	DDR2 667	DDR2	TS256ML Q64V6U		SEC K4T51083QC ES	PASS
Transcend	1GB	DDR2 800	DDR2	TS256ML Q64V6U		ProMOS V59C1512804QBF2 5 (64x8)	PASS
DSL	1GB	DDR2 667	DDR2	NA	NA	ELPIDA E5108AGBG-6E-E (64x8)	PASS
	1GB	DDR2 800	DDR2	NA	NA	Qimonda HYB18T512800BF2 5F(64x8)	PASS
	1GB	DDR2 800	DDR2	NA	NA	ELPIDA E5108AHSE-8E-E	PASS

AIMB-764 Network Feature Comparison

LAN/Model	AIMB-764G2-00A1E	AIMB-764VG-00A1E
LAN1: Intel 82566DM	Yes	Yes
LAN2: Intel 82573L	Yes	No

Product warranty

Advantech warrants to you, the original purchaser, that each of its products will be free from defects in materials and workmanship for two years from the date of purchase.

This warranty does not apply to any products which have been repaired or altered by persons other than repair personnel authorized by Advantech, or which have been subject to misuse, abuse, accident or improper installation. Advantech assumes no liability under the terms of this warranty as a consequence of such events.

If an Advantech product is defective, it will be repaired or replaced at no charge during the warranty period. For out-of-warranty repairs, you will be billed according to the cost of replacement materials, service time and freight. Please consult your dealer for more details.

If you think you have a defective product, follow these steps:

1. Collect all the information about the problem encountered. (For example, type of PC, CPU speed, Advantech products used, other hardware and software used, etc.) Note anything abnormal and list any on-screen messages you get when the problem occurs.
2. Call your dealer and describe the problem. Please have your manual, product, and any helpful information readily available.
3. If your product is diagnosed as defective, obtain an RMA (return material authorization) number from your dealer. This allows us to process your return more quickly.
4. Carefully pack the defective product, a fully-completed Repair and Replacement Order Card and a photocopy proof of purchase date (such as your sales receipt) in a shippable container. A product returned without proof of the purchase date is not eligible for warranty service.
5. Write the RMA number visibly on the outside of the package and ship it prepaid to your dealer.

Initial Inspection

Before you begin installing your motherboard, please make sure that the following materials have been shipped:

- AIMB-764 Intel Core 2 Duo / Pentium D / Pentium 4 / Celeron D processor based industrial motherboard
- 1 AIMB-764 startup manual P/N: 2002076410
- 1 CD with utility P/N: 2066000E10
- 1 FDD cable P/N: 1700340640
- 1 Ultra ATA 66/100 HDD cable P/N: 1701400452
- 2 Serial ATA HDD data cable P/N: 1700003194
- 2 Serial ATA HDD power cable P/N: 1703150102
- 1 COM port cable kit P/N: 1701090401
- 1 I/O port bracket P/N: 1962015680
- 1 jumper package P/N: 9689000068
- 1 warranty card P/N: 2190000902

If any of these items are missing or damaged, contact your distributor or sales representative immediately. We have carefully inspected the AIMB-764 mechanically and electrically before shipment. It should be free of marks and scratches and in perfect working order upon receipt. As you unpack the AIMB-764, check it for signs of shipping damage. (For example, damaged box, scratches, dents, etc.) If it is damaged or it fails to meet the specifications, notify our service department or your local sales representative immediately. Also notify the carrier. Retain the shipping carton and packing material for inspection by the carrier. After inspection, we will make arrangements to repair or replace the unit.

Contents

Chapter 1	Hardware Configuration	2
1.1	Introduction	2
1.2	Features	3
1.3	Specifications	4
1.3.1	System.....	4
1.3.2	Memory.....	4
1.3.3	Input/Output.....	5
1.3.4	Ethernet LAN.....	5
1.3.5	Industrial features	5
1.3.6	Mechanical and environmental specifications.....	5
1.4	Jumpers and Connectors.....	7
	Table 1.1:Jumper list.....	7
	Table 1.2:Connectors.....	7
1.5	Board Layout: Jumper and Connector Locations.....	10
	Figure 1.1:Jumper and Connector locations	10
	Figure 1.2:I/O connectors	11
1.6	AIMB-764 Block Diagram.....	12
	Figure 1.3:AIMB-764 Block Diagram.....	12
1.7	Safety Precautions	13
1.8	Jumper Settings	14
1.8.1	How to set jumpers	14
1.8.2	CMOS clear (J1).....	14
	Table 1.3:CMOS (J1).....	14
1.8.3	Watchdog timer output (JWDT1).....	15
	Table 1.4:Watchdog timer output (JWDT1).....	15
	Table 1.5:ATX/AT mode selector (PSON1)	15
	Table 1.6:COM2 RS-232/422/485 mode selector (JSETCOM2).....	16
	Figure 1.4: COM2 RS-232/422/485 jumper setting	16
1.9	System Memory	16
1.9.1	CPU FSB and memory speed	16
1.10	Memory Installation Procedures	17
1.11	Cache Memory	17
1.12	Processor Installation	17
1.13	PCI Bus Routing Table	19
	Table 1.7:PCI Bus Routing Table.....	19
Chapter 2	Connecting Peripherals	22
2.1	Introduction	22
2.2	Primary (IDE1) IDE Connector	22
2.3	Floppy Drive Connector (FDD1)	23

2.4	Parallel Port (LPT1)	24
2.5	USB Ports (LAN1_USB12, LAN2_USB34, USB56, USB78 & USB910).....	25
2.6	VGA Connector (VGA1)	26
2.7	Serial Ports (COM1 & COM2)	27
2.8	PS/2 Keyboard and Mouse Connector (KBMS1)	28
2.9	External Keyboard & Mouse (KBMS2).....	28
2.10	CPU Fan Connector (CPUFAN1)	29
2.11	System FAN Connector (SYSFAN1 and CHAFAN1) ...	30
2.12	Front Panel Connectors (JFP1, JFP2 & JFP3)	31
2.12.1	Power LED and Keyboard Lock (JFP3).....	31
	Table 2.1:PS/2 or ATX power supply LED status.....	31
2.12.2	External Speaker (JFP2 pins 1, 3, 5 & 7).....	31
2.12.3	HDD LED Connector (JFP2 pins 2 & 4).....	32
2.12.4	SM Bus Connector (JFP2 pins 6 & 8)	32
2.12.5	ATX Soft Power Switch (JFP1 pins 1 & 2).....	32
2.12.6	Reset Connector (JFP1 pins 3 & 4)	32
2.13	H/W Monitor Alarm (JOBS1).....	33
2.14	Line Out, Mic In Connector (AUDIO1).....	34
2.15	Audio Input from CD-ROM (CDIN1)	35
2.16	Front Panel Audio Connector (FP AUDIO; HD1).....	36
2.17	8-pin Alarm Board Connector (VOLT1)	37
2.18	Case Open Connector (JCASE1)	38
2.19	Front Panel LAN Indicator Connector (LANLED1)	38
	Table 2.2:Front Panel LAN Indicator Connector	38
2.20	Serial ATA Interface (SATA1, SATA2, SATA3, SATA4 & SATA5).....	40
2.21	PCI Slots (PCI 1 ~ PCI 5)	41
2.22	PCIe x16 Expansion Slot (PCIe x16_1).....	42
2.23	PCIe x4 Expansion Slot (PCIe x4_1).....	43
2.24	Connecting to SNMP-1000 Remote Manager	43
2.25	Auxiliary 4-pin power connector (ATX1)	44
Chapter 3	Award BIOS Setup.....	46
3.1	Introduction	46
3.1.1	BIOS Setup program.....	46
3.1.2	CMOS RAM Auto-backup and Restore	47
3.2	Entering Setup	48
	Figure 3.1:Award BIOS Setup initial screen	48
3.3	Standard CMOS Setup	48
	Figure 3.2:Standard CMOS Features Screen	48
3.3.1	Date.....	49
3.3.2	Time	49
3.3.3	IDE channel 0/1 Master/Slave	49

3.3.4	Drive A / Drive B.....	49
3.3.5	Video.....	49
3.3.6	Halt On.....	50
3.3.7	Memory.....	50
3.4	Advanced BIOS Features.....	50
	Figure 3.3:Advanced BIOS Features screen.....	50
3.4.1	CPU Features.....	51
3.4.2	Hard Disk Boot Priority.....	51
3.4.3	Virus Warning.....	51
3.4.4	CPU L1, L2 & L3 Cache.....	51
3.4.5	Hyper-Threading Technology.....	51
3.4.6	Quick Power On Self Test.....	51
3.4.7	First/Second/Third Boot Device.....	51
3.4.8	Boot Other Device.....	52
3.4.9	Swap Floppy Drive.....	52
3.4.10	Boot Up Floppy Seek.....	52
3.4.11	Boot Up NumLock Status.....	52
3.4.12	Gate A20 Option.....	52
3.4.13	Typematic Rate Setting.....	52
3.4.14	Typematic Rate (Chars/Sec).....	52
3.4.15	Typematic Delay (msec).....	52
3.4.16	Security Option.....	52
3.4.17	APIC Mode.....	53
3.5	Advanced Chipset Features.....	53
	Figure 3.4:Advanced Chipset Features screen.....	53
3.5.1	Memory Hole At 15M-16M.....	54
3.5.2	Configure AMT BIOS Support (Intel Active Management Technology).....	54
3.5.3	PEG / Onchip VGA Control.....	54
3.5.4	On-Chip Frame Buffer Size.....	54
3.5.5	DVMT Mode.....	54
3.5.6	DVMT / FIXED Memory Size.....	54
3.5.7	Init Display First.....	54
3.6	Integrated Peripherals.....	55
	Figure 3.5:Integrated peripherals.....	55
	Figure 3.6:On-Chip IDE Device.....	55
3.6.1	IDE HDD Block Mode.....	55
3.6.2	IDE DMA Transfer Access.....	55
3.6.3	IDE Primary Master/Slave PIO/UDMA Mode (Auto).....	56
3.6.4	SATA Mode.....	56
3.6.5	Legacy mode support.....	56
	Figure 3.7:USB device setting.....	56
3.6.6	USB 1.0 Controller.....	57
3.6.7	USB Operation mode.....	57
3.6.8	USB storage function.....	57

3.6.9	USB 2.0 Controller	57
3.6.10	USB Keyboard / Mouse Support	57
	Figure 3.8:Onboard Device.....	57
3.6.11	On board LAN1 ROM	57
3.6.12	Onboard LAN2 Control	58
3.6.13	On board LAN2 ROM	58
	Figure 3.9:Super I/O Device.....	58
3.6.14	Onboard FDC Controller	58
3.6.15	Onboard Serial Port 1	58
3.6.16	Onboard Serial Port 2	58
3.6.17	UART Mode Select	58
3.6.18	RxD, TxD Active.....	59
3.6.19	IR Transmission Delay	59
3.6.20	UR2 Duplex Mode.....	59
3.6.21	Use IR Pins	59
3.6.22	Onboard Parallel Port.....	59
3.6.23	Parallel Port Mode	59
3.6.24	EPP Mode Select	59
3.6.25	ECP Mode Use DMA	59
3.7	Power Management Setup.....	60
	Figure 3.10:Power management setup screen.....	60
3.7.1	Power Supply Type.....	60
3.7.2	ACPI Function	60
3.7.3	ACPI Suspend Type.....	60
3.7.4	Power Management	61
	Table 3.1:Power Saving	61
3.7.5	Video Off Method.....	61
3.7.6	Video Off In Suspend	61
3.7.7	Suspend Type.....	61
3.7.8	Suspend Mode.....	61
3.7.9	HDD Power Down.....	61
3.7.10	Soft-Off by PWR-BTTN	61
3.7.11	PowerOn by LAN	62
3.7.12	PowerOn by Modem	62
3.7.13	PowerOn by Alarm	62
3.7.14	Primary IDE 0 (1) and Secondary IDE 0 (1)	62
3.7.15	FDD, COM, LPT PORT	62
3.7.16	PCI PIRQ [A-D]#	62
3.7.17	PWRON After PWR-Fail	62
3.8	PnP/PCI Configurations	63
	Figure 3.11:PnP/PCI configurations screen.....	63
3.8.1	Reset Configuration Data.....	63
3.8.2	Resources Controlled By	63
3.8.3	PCI / VGA Palette Snoop	63
3.8.4	Maximum Payload Size	63

3.9	PC Health Status.....	64
	Figure 3.12:PC Health Status Screen.....	64
3.9.1	Case Open Warning.....	64
3.9.2	Current System Temperature.....	64
3.9.3	CPU FAN Speed.....	64
3.9.4	System FAN Speed.....	64
3.9.5	VCORE and Other Voltages.....	64
3.10	Frequency / Voltage Control.....	65
	Figure 3.13:Spread Spectrum Frequency/Voltage Control screen.....	65
3.10.1	Spread Spectrum.....	65
3.11	Password Setting.....	66
3.12	Save & Exit Setup.....	67
3.13	Exit Without Saving.....	67
Chapter 4	Chipset Software Install Utility.....	70
4.1	Before you begin.....	70
4.2	Introduction.....	70
4.3	Windows XP Driver Setup.....	71
Chapter 5	VGA Setup.....	76
5.1	Introduction.....	76
5.2	Windows XP Driver Setup.....	77
Chapter 6	Onboard Security Setup.....	82
6.1	Introduction.....	82
6.2	Windows XP Driver Setup.....	82
6.3	Using the OBS Hardware Doctor Utility.....	85
Chapter 7	LAN Configuration.....	88
7.1	Introduction.....	88
7.2	Features.....	88
7.3	Installation.....	88
7.4	Win XP Driver Setup (LAN).....	89
Chapter 8	AMT Setup.....	94
8.1	Intel AMT Overview.....	94
8.2	Windows XP Intel ME (Management Engine) Interface Setup.....	95
8.3	Windows XP AMT ME Driver Setup.....	99
Appendix A	Programming the Watchdog Timer.....	104
A.1	Watchdog timer overview.....	104
A.2	Programming the Watchdog Timer.....	104
A.2.1	Example Programs.....	106
	Table A.1:Watchdog timer registers.....	106

Appendix B	Pin Assignments	114
B.1	IDE Hard Drive Connector (IDE1)	114
	Table B.1:IDE hard drive connector (IDE1)	114
B.2	Floppy Drive Connector (FDD1)	115
	Table B.2:Floppy drive connector (FDD1).....	115
B.3	Parallel Port (LPT1)	116
	Table B.3:Parallel Port (LPT1).....	116
B.4	USB Header (USB56,USB78,USB910).....	117
	Table B.4:USB Header (USB56,USB78,USB910)....	117
B.5	VGA Connector (VGA1)	117
	Table B.5:VGA Connector (VGA1).....	117
B.6	RS-232 Interface (COM1).....	118
	Table B.6:RS-232 Interface (COM1)	118
B.7	RS-232/422/485 Interface (COM2)	119
	Table B.7:RS-232 Interface (COM2)	119
B.8	PS/2 Keyboard and Mouse Connector (KBMS1)	120
	Table B.8:Keyboard & Mouse Connector (KBMS1) .	120
B.9	External Keyboard Connector (KBMS2).....	121
	Table B.9:External Keyboard Connector (KBMS2)...	121
B.10	Infrared (IR) connector (JIR1)	121
	Table B.10:Infrared Connector (JIR1).....	121
B.11	CPU/System Fan Power Connector (SYSFAN1/ CHAFAN1)	122
	Table B.11:Fan Power Connector (SYSFAN1/ CHAFAN1).....	122
B.12	Power LED and Keyboard Lock (JFP3)	122
	Table B.12: Power LED and Keyboard Lock (JFP3) .	122
B.13	External Speaker Connector (JFP2)	123
	Table B.13:External Speaker Connector (JFP2).....	123
B.14	Reset Connector (JFP1).....	123
	Table B.14:Reset Connector (JFP1)	123
B.15	HDD LED Connector (JFP2)	124
	Table B.15:HDD LED Connector (JFP2).....	124
B.16	ATX Soft Power Switch (JFP1).....	124
	Table B.16:ATX Soft Power Switch (JFP1).....	124
B.17	H/W Monitor Alarm (JOBS1).....	125
	Table B.17:H/W Monitor Alarm (JOBS1)	125
B.18	SM Bus Connector (JFP2).....	125
	Table B.18:SM Bus Connector (JFP2)	125
B.19	USB/LAN ports (LAN1_USB12 and LAN2_USB34) .	126
	Table B.19:USB Port	126
	Table B.20:10/100/1000Base-T RJ-45 port.....	126
B.20	Line Out, Mic IN Connector (AUDIO1).....	126

B.21	Audio Input from CD-ROM (CDIN1)	127
	Table B.21:Audio Input from CD-ROM	127
B.22	Front Panel Audio Connector (FP AUDIO; HD1).....	127
	Table B.22:Audio Connector (FP AUDIO; HD1).....	127
B.23	8-pin Alarm Board Connector (VOLT1)	128
	Table B.23:8-pin Alarm Board Connector (VOLT1) .	128
B.24	Case Open Connector (JCASE1)	128
	Table B.24:Case Open Connector (JCASE1).....	128
B.25	Front Panel LAN LED Connector (LANLED1).....	129
	Table B.25:LAN LED Connector (LANLED1)	129
B.26	System I/O Ports.....	130
	Table B.26:System I/O ports	130
B.27	DMA Channel Assignments.....	131
	Table B.27:DMA channel assignments	131
B.28	Interrupt Assignments	132
	Table B.28:Interrupt assignments	132
B.29	1st MB Memory Map.....	132
	Table B.29:1st MB memory map	132

CHAPTER

1

Hardware Configuration

Chapter 1 Hardware Configuration

1.1 Introduction

The AIMB-764 is the most advanced Intel Q965 product for industrial applications that require high-performance computing. The motherboard supports Intel Core 2 Duo / Dual-Core Pentium D / Pentium 4 / Celeron D processors with 533/800/1066 MHz front side bus and DDR2 533/667/800 MHz memory up to 8 GB.

The AIMB-764 incorporates the Intel Q965 chipset to offer cost-effective integrated graphics. The Q965 chipset uses the Intel Extreme Graphics architecture to maximize VGA performance and share up to 256 MB of system memory. When higher graphics performance is needed, the AIMB-764 provides a mainstream PCIe x16 expansion slot for add-on graphic cards. In addition, the AIMB-764 has a single/dual Gigabit Ethernet LAN via a dedicated PCIe x1 bus, which offers bandwidth of up to 500 MB/s, eliminating network bottlenecks. High reliability and outstanding performance make the the AIMB-764 the ideal platform for industrial networking applications.

By using the Intel ICH8DO chipset, the AIMB-764 offers five 32-bit, 33-MHz PCI slots; one PCIe x4 slot, one PCIe x16 slot and a variety of features such as 5 on-board SATA II interfaces (bandwidth = 300 MB/s) with software for RAID 0, 1, 10 and 5; 10 USB 2.0 connections; 1 ATA 100/66/33 port; and HD Audio. These powerful I/O capabilities ensure even more reliable data storage capabilities and high-speed I/O peripheral connectivity. When accompanied by Advantech's SNMP-1000 intelligent SNMP/HTTP system manager module, the AIMB-764 permits users to monitor and manage the system remotely. This is particularly crucial for mission-critical applications.

The AIMB-764 also adopts Advantech's unique patented "Sleep Mode Control Circuit" for AT Power Mode.

With all the excellent features and outstanding performance, the AIMB-764 is definitely the ideal platform for today's industrial applications.

1.2 Features

- **PCIe architecture:** The Intel Q965 and ICH8DO PCIe chipset provide 1 PCIe x16 slot, 1 PCIe x4 slot and a PCIe x1 link for the Gigabit LAN.
- **High Performance I/O Capability:** Dual/single Gigabit LAN via PCIe x1 bus, 5 PCI 32-bit/33MHz PCI slots, 5 SATA2 connectors and 10 USB 2.0 ports.
- **Standard ATX form factor with industrial features:** AIMB-764 provides industrial features like long product life, reliable operation under wide temperature range, watchdog timer, CMOS backup functions, etc.
- **Health status monitoring and remote management:** System voltage levels, fan speed and CPU temperature are monitored to ensure stable operation. The remote management interface allows the system to be managed through Ethernet when it is connected to the SNMP-1000 Remote HTTP/SNMP System Manager.
- **BIOS CMOS backup and restore:** When BIOS CMOS setup has been completed, data in the CMOS RAM is automatically backed up to the Flash ROM. This is particularly useful in harsh environments which may cause setup data loss such as battery failure. Upon such an error occurring, the BIOS will check the data, and automatically restore the original data for booting.
- **Automatically power on after power failure:** It is often required to have an unattended system come back to operation when power resumes after a power failure. Advantech's industrial motherboard allows users to set the system to power on automatically without pushing the power on button.

1.3 Specifications

1.3.1 System

- **CPU:** Intel LGA 775 Core 2 Duo, Pentium D, Pentium 4, Celeron D up to 2.66/3.4/3.8/3.2 GHz, FSB 533/800/1066 MHz. Advantech also certifies several optional high-performance CPU coolers for high-speed CPUs in 2U chassis or in high-temperature environments.

Note: *Advantech certifies two LGA775 CPU cooler solutions. Both coolers are capable of keeping the temperature of 115W-thermal-spec CPUs within specification under environmental temperatures of 55° C without a chassis or 40° C with a chassis.*

1750000334: LGA 775 CPU cooler up to 3.8 GHz (115 W), 4U, 5U and 7U chassis

1750001661: LGA 775 CPU cooler up to 3.8 GHz (115 W), 2U, 4U, 5U and 7U chassis

- **L2 Cache:** CPU has one of the following built-in full-speed L2 caches
2 x 1024 KB / 2 x 2048 KB for Pentium D CPUs,
2 x 4096 MB for Intel Core 2 Duo CPUs,
1024 KB / 2048 KB for Pentium 4 CPUs,
256 KB / 512 KB for Celeron D CPUs
- **BIOS:** Award 16 Mbit SPI
- **System Chipset:** Intel Q965 with ICH8DO
- **SATA hard disk drive interface:** Five on-board SATA2 connectors support Advanced Host controller interface (AHCI) technology and have data transmission rates up to 300 MB/s.
- **One on-board IDE connector:** Supports PIO mode 4 (16.67 MB/s) and ATA 33/66/100 (33/66/100 MB/s) BIOS enabled/disabled.
- **Floppy disk drive interface:** Supports one floppy disk drive, 5¼" (360 KB and 1.2 MB) or 3½" (720 KB, 1.44 MB). BIOS enable/disable

1.3.2 Memory

- **RAM:** Up to 8 GB in four 240-pin DIMM sockets. Supports dual-channel DDR2 533/667/800 SDRAM.

Note:

1. A 64-bit OS may not fully detect 8 GB of RAM when 8 GB is installed.
2. A 32-bit OS may not fully detect 4 GB of RAM when 4 GB is installed.

1.3.3 Input/Output

- **PCIe slots:** 1 PCIe x16 expansion slot and 1 PCIe x4 expansion slot.
- **PCI Bus:** 5 PCI slots, 32-bit, 33 MHz PCI 2.2 compliant
- **Enhanced parallel port:** Configured to LPT1, LPT2, LPT3, or disabled. Standard DB-25 female connector provided. Supports EPP/SPP/ECP
- **Serial ports:** Two serial ports, one DB-9 (RS-232) connector and one onboard pin header (RS-232/422/485). Ports can be individually configured to COM1, COM2, or disabled
- **Keyboard and PS/2 mouse connector:** Two 6-pin mini-DIN connectors are located on the mounting bracket for easy connection to a PS/2 keyboard and mouse.
- **USB port:** Supports up to eight USB 2.0 ports with transmission rates up to 480 Mbps.

1.3.4 Ethernet LAN

- Supports single/dual 10/100/1000Base-T Ethernet port(s) via PCIe x1 bus which provides a 500 MB/s data transmission rate.
- **Interface:** 10/100/1000Base-T
- **Controller:** LAN1: Intel 82566DM, LAN2: Intel 82573L

1.3.5 Industrial features

- **Watchdog timer:** Can generate a system reset or IRQ11. The watchdog timer is programmable, with each unit equal to one second or one minute (255 levels).

1.3.6 Mechanical and environmental specifications

- **Operating temperature:** 0 ~ 55° C (32 ~ 131° F, Depending on CPU)
- **Storage temperature:** -20 ~ 70° C (-4 ~ 158° F)
- **Humidity:** 20 ~ 95% non-condensing
- **Power supply voltage:** +3.3 V, ±5 V, ±12 V

- **Power consumption:** Maximum: +5 V at 4.5 A, +3.3 V at 4 A, +12 V at 10 A, 5 Vsb at 1 A (Intel Core 2 Duo 2.13 GHz and four 1 GB DDR2 667 SDRAM)
- **Board size:** 304.8 x 228.6 mm (12" x 9.6")
- **Board weight:** 0.5 kg (1.68 lb)

1.4 Jumpers and Connectors

Connectors on the AIMB-764 motherboard link it to external devices such as hard disk drives and a keyboard. In addition, the board has a number of jumpers that are used to configure your system for your application.

The tables below list the function of each of the jumpers and connectors. Later sections in this chapter give instructions on setting jumpers. Chapter 2 gives instructions for connecting external devices to your motherboard.

Table 1.1: Jumper list

Label	Function
J1	CMOS
JWDT1	Watchdog reset
PSON1	AT(1-2) / ATX(2-3)
JSETCOM2	COM2 RS-232/422/485 jumper setting

Table 1.2: Connectors

Label	Function
IDE1	Primary IDE connector (one channel)
FDD1	FDD connector
LPT1	Parallel port, parallel port x 1, supports SPP/EPP/ECP mode
LAN1_USB12	LAN1 / USB port 1, 2
LAN2_USB34	LAN2 / USB port 3, 4
VGA1	VGA connector
COM1	Serial port: COM1; RS-232
COM2	Serial port: COM2; RS-232 (9-pin connector)
KBMS1	PS/2 keyboard and mouse connector
KBMS2	External keyboard connector (6-pin)
JIR1	Infrared connector

Table 1.2: Connectors

Label	Function
JFP3	Keyboard lock and power LED Suspend: fast flash (ATX/AT) System On: on (ATX/AT) System Off: off (AT) System Off: slow flash (ATX)
JFP2	External speaker / SATA HDD LED connector / SM Bus connector
JFP1	Power switch / reset connector
JCASE1	Case open
VOLT1	Voltage display
JOBS1	HW monitor Close: enable OBS alarm Open: disable OBS alarm
CPUFAN1	CPU fan connector (4-pin)
SYSFAN1	System fan connector (4-pin)
CHAFAN1	Chassis fan connector (4-pin)
LANLED1	LAN1/2 LED extension connector
AUDIO1	Audio connector
CDIN1	CD_IN connector
HD1	HD audio front panel pin header
USB56	USB port 5, 6
USB78	USB port 7, 8
USB910	USB port 9, 10
SA1	Serial ATA1
SA2	Serial ATA2
SA3	Serial ATA3
SA4	Serial ATA4
SA5	Serial ATA5
ATX1	ATX 12 V auxiliary power connector (for CPU)
ATX2	ATX 24-pin main power connector (for system)
PCIEX16_1	PCIe x16 slot 1
PCIEX4_1	PCIe x4 slot 1
PCIEX_SW1	PCIe x4 slot 1 by 1 x PCIe_4 (ON) PCIe x4 slot 1 by 4 x PCIe_1 (1-2)
PCI1	PCI slot 1
PCI2	PCI slot 2

Table 1.2: Connectors

Label	Function
PCI3	PCI slot 3
PCI4	PCI slot 4
PCI5	PCI slot 5
BT1	Battery connector
SP1	Buzzer
CPU1	CPU socket
DIMMA1	Channel A DIMM1
DIMMA2	Channel A DIMM2
DIMMB1	Channel B DIMM1
DIMMB2	Channel B DIMM2
SPI_CN1	Update BIOS pin header

1.5 Board Layout: Jumper and Connector Locations

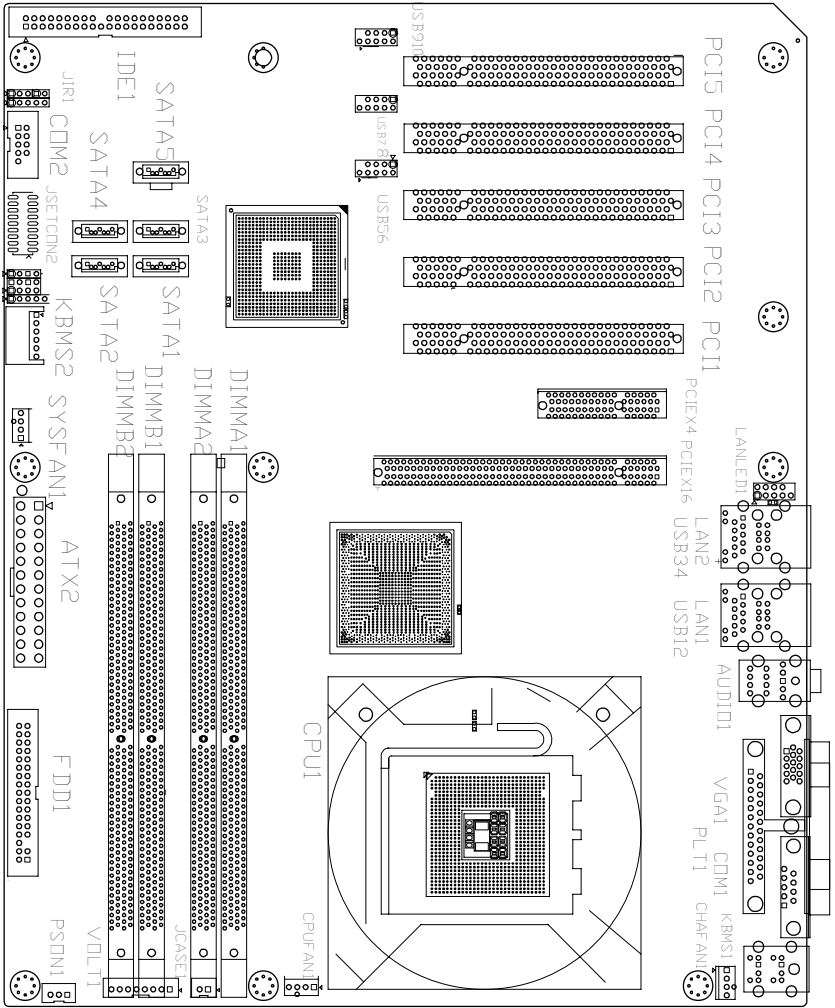

Figure 1.1: Jumper and Connector locations

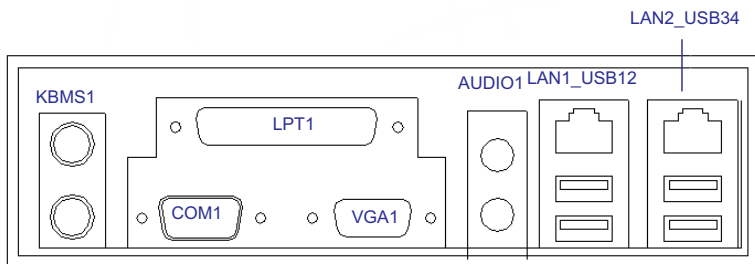

Figure 1.2: I/O connectors

1.6 AIMB-764 Block Diagram

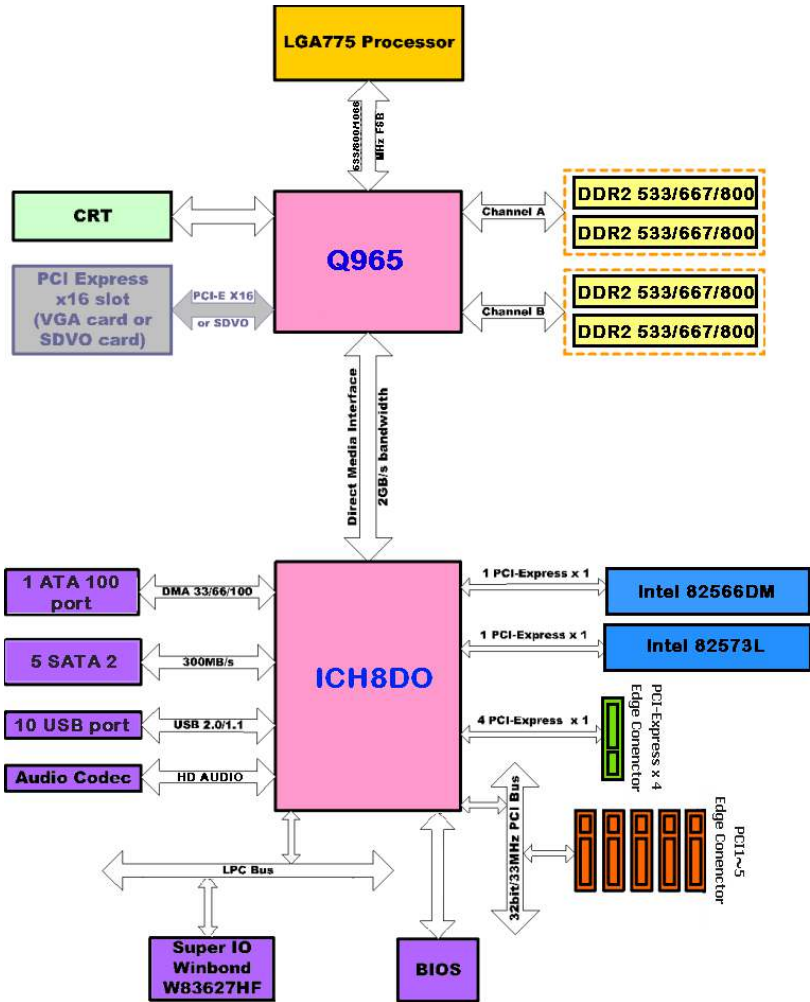

Figure 1.3: AIMB-764 Block Diagram

1.7 Safety Precautions

Warning! *Always completely disconnect the power cord from your chassis whenever you work with the hardware. Do not make connections while the power is on. Sensitive electronic components can be damaged by sudden power surges. Only experienced electronics personnel should open the PC chassis.*

Caution! *Always ground yourself to remove any static charge before touching the motherboard. Modern electronic devices are very sensitive to static electric charges. As a safety precaution, use a grounding wrist strap at all times. Place all electronic components on a static-dissipative surface or in a static-shielded bag when they are not in the chassis.*

Caution! *The computer is provided with a battery-powered Real-time Clock circuit. There is a danger of explosion if battery is incorrectly replaced. Replace only with same or equivalent type recommended by the manufacturer. Discard used batteries according to manufacturer's instructions.*

Caution! *There is a danger of a new battery exploding if it is incorrectly installed. Do not attempt to recharge, force open, or heat the battery. Replace the battery only with the same or equivalent type recommended by the manufacturer. Discard used batteries according to the manufacturer's instructions.*

1.8 Jumper Settings

This section provides instructions on how to configure your motherboard by setting the jumpers. It also includes the motherboard default settings and your options for each jumper.



1.8.1 How to set jumpers

You can configure your motherboard to match the needs of your application by setting the jumpers. A jumper is a metal bridge that closes an electrical circuit. It consists of two metal pins and a small metal clip (often protected by a plastic cover) that slides over the pins to connect them. To “close” (or turn on) a jumper, you connect the pins with the clip. To “open” (or turn off) a jumper, you remove the clip. Sometimes a jumper consists of a set of three pins, labeled 1, 2, and 3. In this case you connect either pins 1 and 2, or 2 and 3. A pair of needle-nose pliers may be useful when setting jumpers.

1.8.2 CMOS clear (J1)

The AIMB-764 motherboard contains a jumper that can erase CMOS data and reset the system BIOS information. Normally this jumper should be set with pins 1-2 closed. If you want to reset the CMOS data, set J1 to 2-3 closed for just a few seconds, and then move the jumper back to 1-2 closed. This procedure will reset the CMOS to its default setting.



Table 1.3: CMOS (J1)

Function	Jumper Setting
* Keep CMOS data	 1-2 closed
Clear CMOS data	 2-3 closed
* default setting	

1.8.3 Watchdog timer output (JWDT1)

The AIMB-764 contains a watchdog timer that will reset the CPU or send a signal to IRQ11 in the event the CPU stops processing. This feature means the AIMB-764 will recover from a software failure or an EMI problem. The J2 jumper settings control the outcome of what the computer will do in the event the watchdog timer is tripped.

Table 1.4: Watchdog timer output (JWDT1)

Function	Jumper Setting
IRQE	1  1-2 closed
* Reset	1  2-3 closed

*default setting

Note: The interrupt output of the watchdog timer is a low level signal. It will be held low until the watchdog timer is reset.

Table 1.5: ATX/AT mode selector (PSON1)



Function	Jumper Setting
AT Mode	1  1-2 closed
ATX Mode	1  2-3 closed

Table 1.6: COM2 RS-232/422/485 mode selector (JSETCOM2)

Use JP1 to select the RS-232/422/485 mode for COM2 (CN10). The default setting is RS-232.

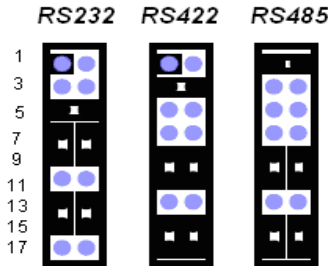

Figure 1.4: COM2 RS-232/422/485 jumper setting

1.9 System Memory

The AIMB-764 has four sockets for 240-pin dual inline memory modules (DIMMs) in two memory channels.

All these sockets use 1.8 V unbuffered double data rate synchronous DRAMs (DDR SDRAM). They are available in capacities of 256, 512, 1024 and 2048 MB. The sockets can be filled in any combination with DIMMs of any size, giving a total memory size between 256 MB and 8 GB.

1.9.1 CPU FSB and memory speed

The AIMB-764 can accept DDR2 SDRAM memory chips without parity. Also note that the AIMB-764 accepts DDR2 533/667/800 MHz SDRAM, and DDR2 SDRAM. The AIMB-764 does not support ECC (error checking and correction).

1.10 Memory Installation Procedures

To install DIMMs, first make sure the two handles of the DIMM socket are in the “open” position. i.e. The handles lean outward. Slowly slide the DIMM module along the plastic guides on both ends of the socket, and then press the DIMM module right down into the socket, until you hear a click. This is when the two handles have automatically locked the memory module into the correct position of the DIMM socket. To remove the memory module, just push both handles outward, and the memory module will be ejected by the mechanism in the socket.

1.11 Cache Memory

The AIMB-764 supports a CPU with one of the following built-in full-speed L2 caches:

- 2 x 1024 KB / 2 x 2048 KB for Pentium D CPUs
- 2 x 4096 MB for Intel Core 2 Duo CPUs
- 1024 KB / 2048 KB for Pentium 4 CPUs
- 256 KB / 512 KB for Celeron D CPUs

The built-in second-level cache in the processor yields much higher performance than conventional external cache memories.

1.12 Processor Installation

The AIMB-764 is designed for Intel Pentium 4, Intel Core 2 Duo, Celeron D and Intel Pentium D processors.

1. Pull the bar besides the CPU socket outward and lift it.



2. Align the triangular marking on the processor with the cut edge of the socket.

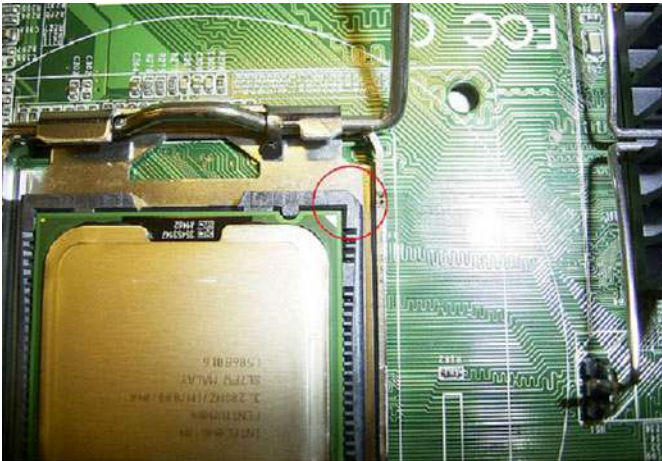

- Put back the socket cap and press down the bar to fix it.



1.13 PCI Bus Routing Table

Table 1.7: PCI Bus Routing Table

PCI Slot	ID SEL	PCI Interrupt
PCI1	AD31	INT B, C, D, A
PCI2	AD30	INT C, D, A, B
PCI3	AD29	INT D, A, B, C
PCI4	AD28	INT A, B, C, D
PCI5	AD27	INT B, C, D, A

CHAPTER
2

**Connecting
Peripherals**

Chapter 2 Connecting Peripherals

2.1 Introduction

You can access most of the connectors from the top of the board as it is being installed in the chassis. If you have a number of cards installed, you may need to partially remove a card to make all the connections.

2.2 Primary (IDE1) IDE Connector

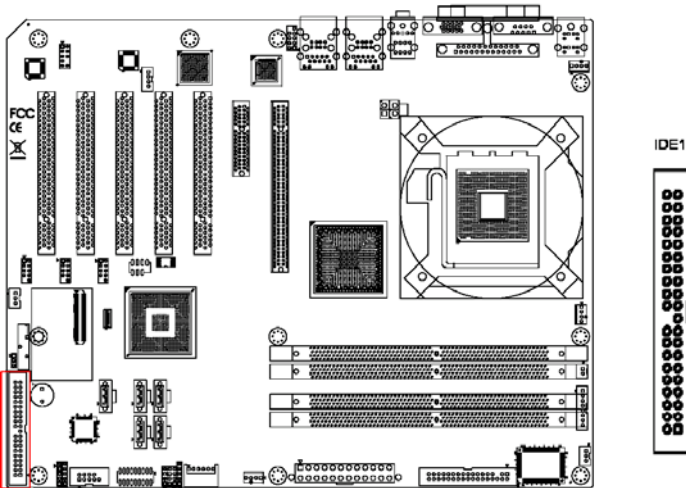

You can attach up to one IDE (Integrated Drive Electronics) drive to the AIMB-764's built-in controller.

Wire number 1 on the cable is red or blue and the other wires are gray. Connect one end to connector IDE1 on the motherboard. Make sure that the red/blue wire corresponds to pin 1 on the connector (in the upper right hand corner).

Connect the hard drive to the other end of the cable. Wire 1 on the cable should also connect to pin 1 on the hard drive connector, which is labeled on the drive circuit board. Check the documentation that came with the drive for more information.

2.3 Floppy Drive Connector (FDD1)

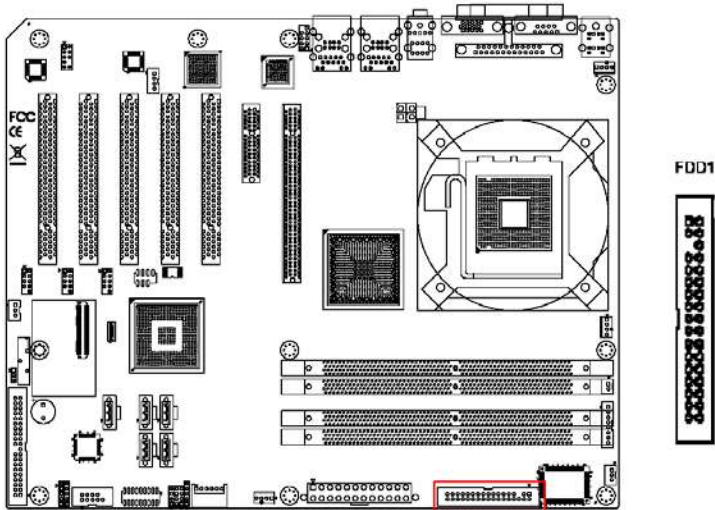

You can attach up to two floppy disk drives to the AIMB-764's onboard controller. You can use 3.5" (720 KB, 1.44 MB) drives.

The motherboard comes with a 34-pin daisy-chain drive connector cable. On one end of the cable is a 34-pin flat-cable connector. On the other end are two 34-pin flat-cable connectors (usually used for 3.5" drives). The connector on the end (after the twist in the cable) connects to the A: floppy drive. The connector in the middle connects to the B: floppy drive.

2.4 Parallel Port (LPT1)

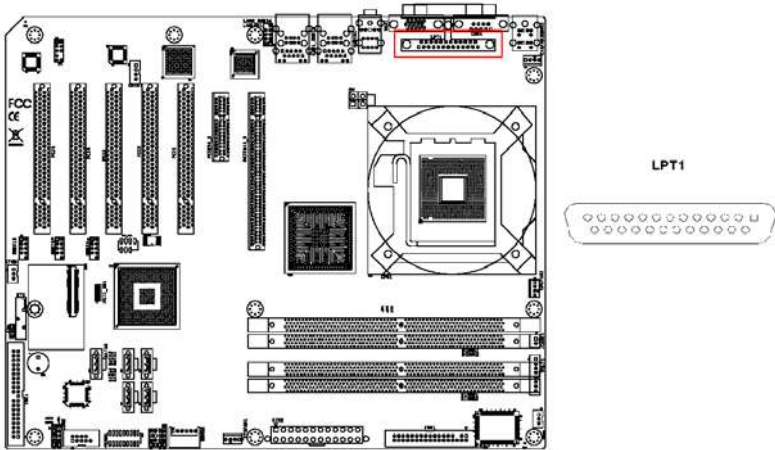

The parallel port is normally used to connect the motherboard to a printer. The AIMB-764 includes an onboard parallel port, accessed through a 26-pin flat-cable connector, LPT1.

2.5 USB Ports (LAN1_USB12, LAN2_USB34, USB56, USB78 & USB910)

The AIMB-764 provides up to 10 USB (Universal Serial Bus) ports. These ports support Plug & Play and hot swapping for up to 127 external devices. The USB ports comply with USB Specification Rev. 2.0. Transmission rates of up to 480 Mbps and fuse protection are supported. The USB interface can be disabled in the system BIOS setup.

The AIMB-764 is equipped with one or two high-performance 1000 Mbps Ethernet LANs. They are supported by all major network operating systems. The RJ-45 jacks on the rear plate provide convenient or 1000Base-T operation.

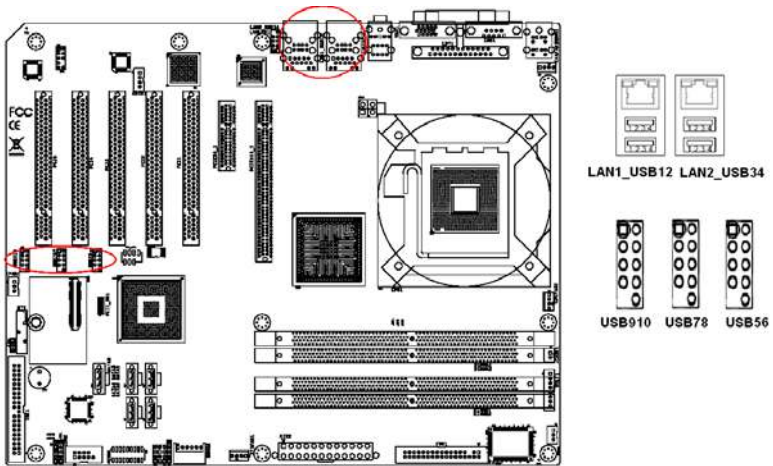

2.6 VGA Connector (VGA1)

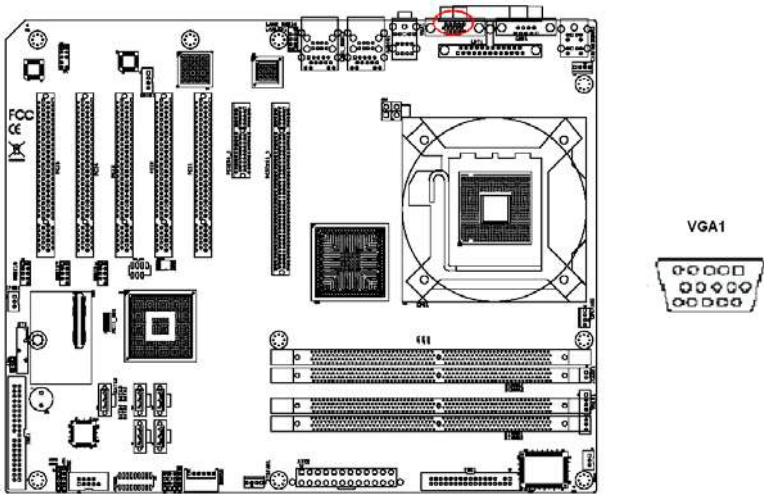

The AIMB-764 includes a VGA interface that can drive conventional CRT displays. VGA1 is a standard 15-pin D-SUB connector commonly used for VGA. Pin assignments for CRT connector VGA1 are detailed in Appendix B.

2.7 Serial Ports (COM1 & COM2)

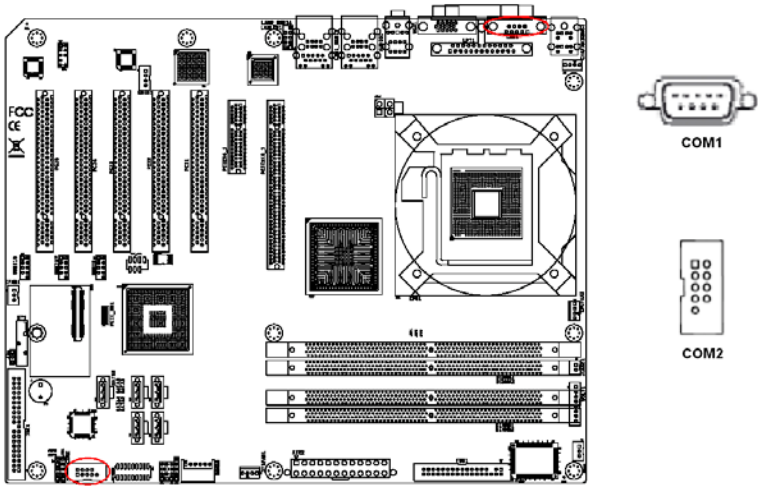

The AIMB-764 offers two serial ports (one on the rear panel and one onboard). JP1 is used to select the RS 232/422/485 mode for COM2. These ports can connect to a serial mouse, printer or communications network.

The IRQ and address ranges for both ports are fixed. However, if you want to disable the port or change these parameters later, you can do this in the system BIOS setup.

Different devices implement the RS-232/422/485 standards in different ways. If you are having problems with a serial device, be sure to check the pin assignments for the connector.

2.8 PS/2 Keyboard and Mouse Connector (KBMS1)

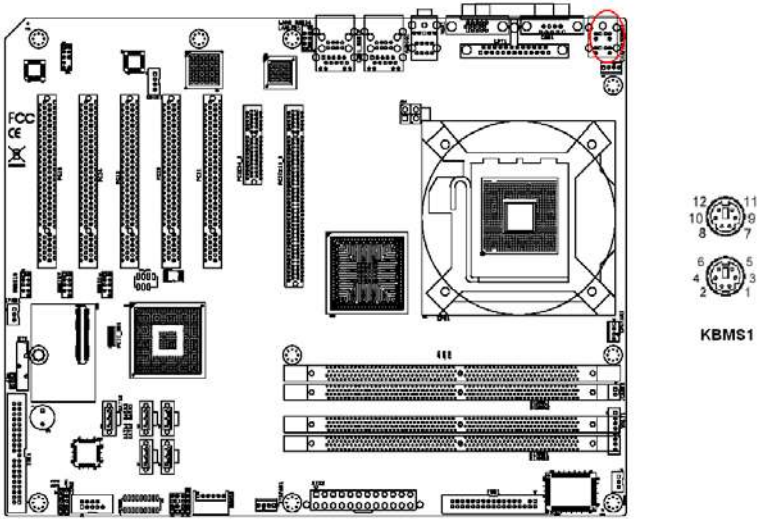

Two 6-pin mini-DIN connectors (KBMS1) on the rear panel of the motherboard provide PS/2 keyboard and mouse connections.

2.9 External Keyboard & Mouse (KBMS2)

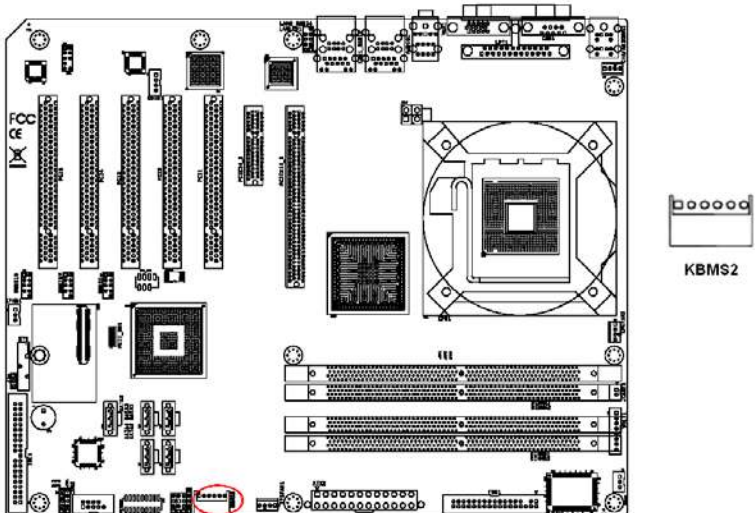

There is also an extra onboard external keyboard and mouse connector on the motherboard. This gives system integrators greater flexibility in designing their systems.

2.10 CPU Fan Connector (CPUFAN1)

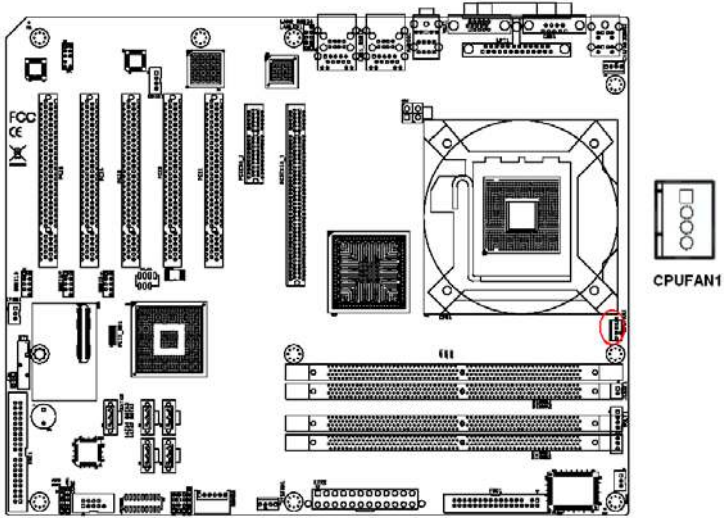

If a fan is used, this connector supports cooling fans that draw up to 500 mA (6 W).

2.11 System FAN Connector (SYSFAN1 and CHAFAN1)

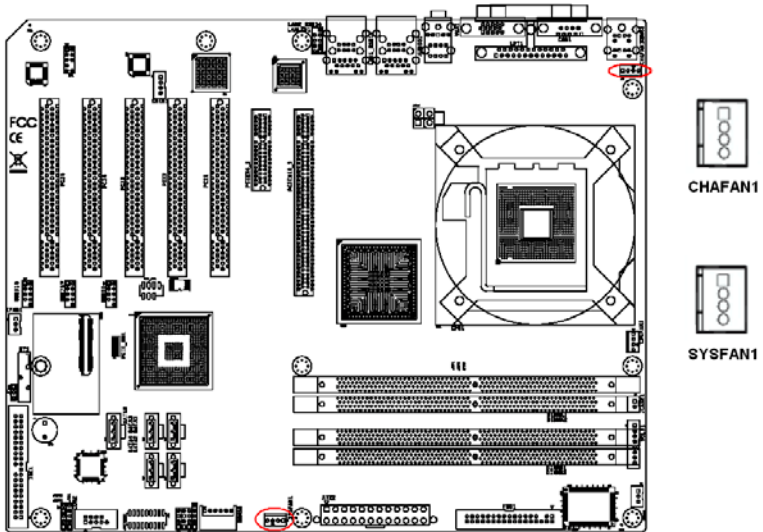

If a fan is used, this connector supports cooling fans that draw up to 500 mA (6 W).

2.12 Front Panel Connectors (JFP1, JFP2 & JFP3)

There are several external switches and LEDs to monitor and control the AIMB-764.

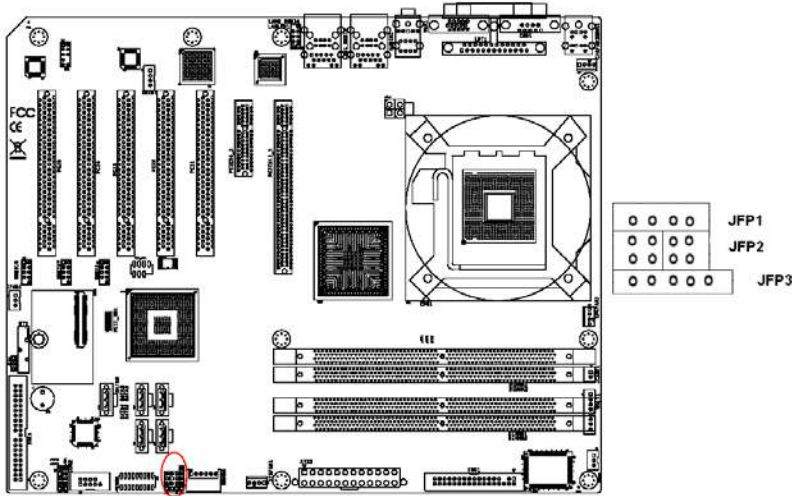

2.12.1 Power LED and Keyboard Lock (JFP3)

JFP3 is a 5-pin connector for the power LED. Refer to Appendix B for detailed information on the pin assignments. If a PS/2 or ATX power supply is used, the system's power LED status will be as indicated as follows.

Table 2.1: PS/2 or ATX power supply LED status

Power mode	LED (PS/2 power)	LED (ATX power)
System On	On	On
System Suspend	Fast flashes	Fast flashes
System Off	Off	Slow flashes

2.12.2 External Speaker (JFP2 pins 1, 3, 5 & 7)

JFP2 is a 8-pin connector for an external speaker. The AIMB-764 provides an onboard buzzer as an alternative. To enable the buzzer, set pins 5-7 as closed.

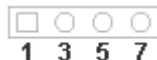

2.12.3 HDD LED Connector (JFP2 pins 2 & 4)

You can connect an LED to connector JFP2 to indicate when the HDD is active.



2.12.4 SM Bus Connector (JFP2 pins 6 & 8)

This connector is reserved for Advantech's SNMP-1000 HTTP/SNMP Remote System Manager. The SNMP-1000 allows users to monitor the internal voltages, temperature and fans from a remote computer through an Ethernet network.

Pins 6 and 8 of JFP2 can be connected to CN19 of the SNMP-1000. Please be careful about the pin assignments. Pin 6 must be connected to pin 1 and pin 8 to pin 2 on both ends of cable.

2.12.5 ATX Soft Power Switch (JFP1 pins 1 & 2)

If your computer case is equipped with an ATX power supply, you should connect the power on/off button on your computer case to pins 1 and 2 of JFP1. This connection enables you to turn your computer on and off.

2.12.6 Reset Connector (JFP1 pins 3 & 4)

Many computer cases offer the convenience of a reset button.



2.13 H/W Monitor Alarm (JOBS1)

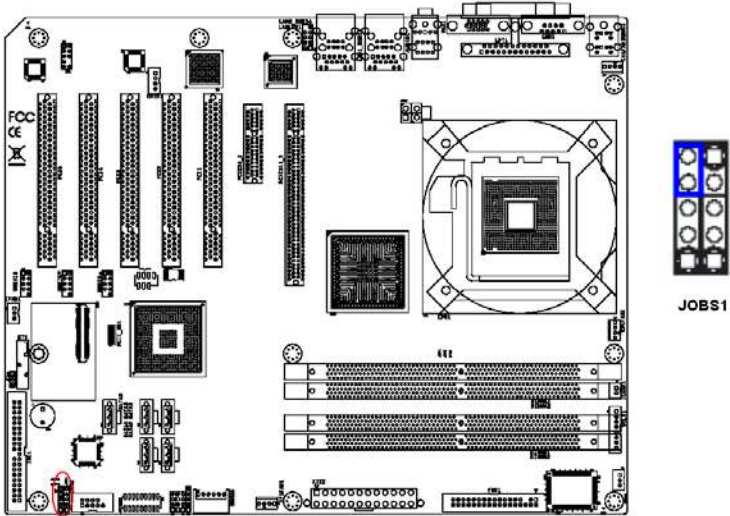

Close: Enable OBS Alarm

Open: Disable OBS Alarm

2.14 Line Out, Mic In Connector (AUDIO1)

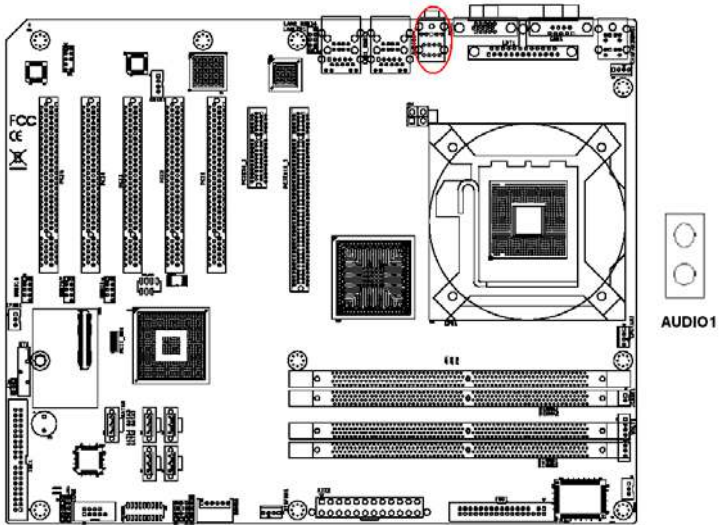

Line Out can be connected to external audio devices like speakers or headphones. Mic In can be connected to a microphone.

2.15 Audio Input from CD-ROM (CDIN1)

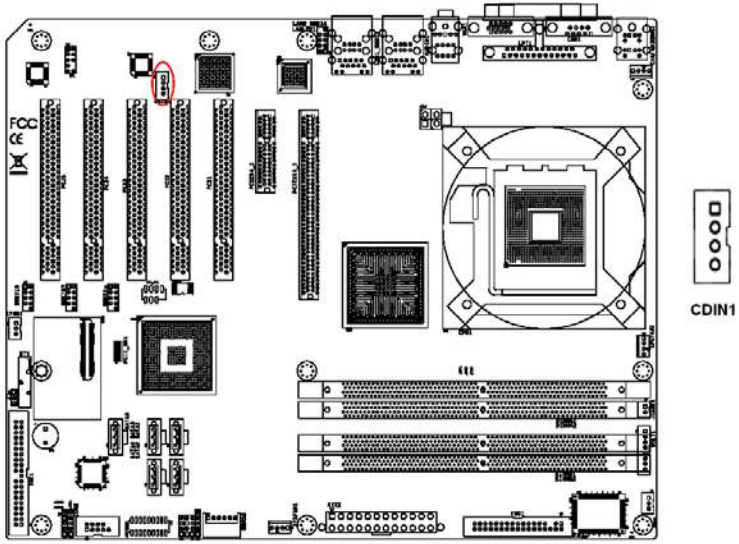

CDIN is connected the CD-ROM audio output.

2.16 Front Panel Audio Connector (FP AUDIO; HD1)

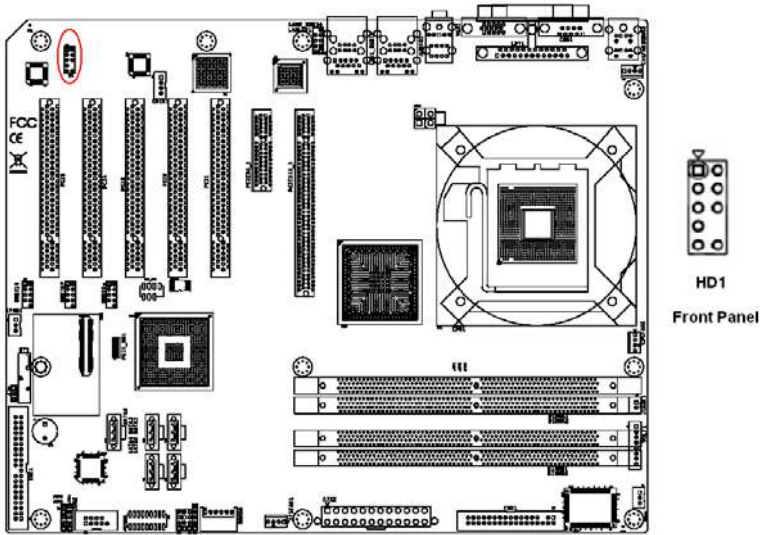

The FPAUDIO is a front panel audio connector that follows the Intel Front Panel I/O Connectivity Design Guide.

2.17 8-pin Alarm Board Connector (VOLT1)

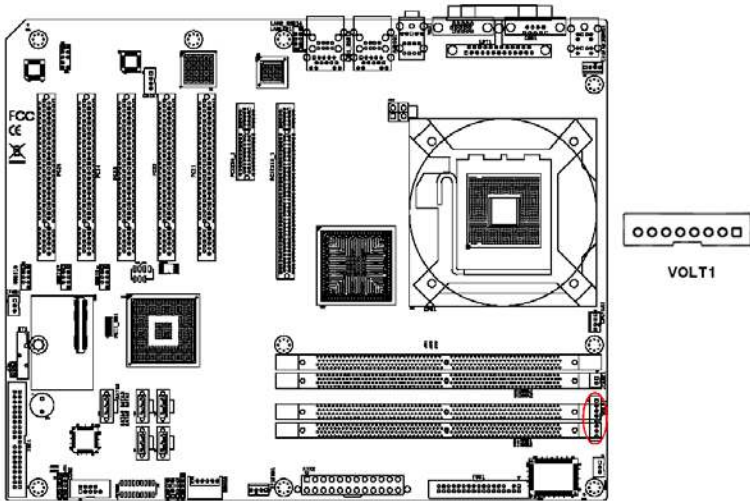

VOLT1 connects to the alarm board of Advantech chassis. These alarm boards give warnings if a power supply or fan fails; if the chassis overheats; or if the backplane malfunctions.

2.18 Case Open Connector (JCASE1)

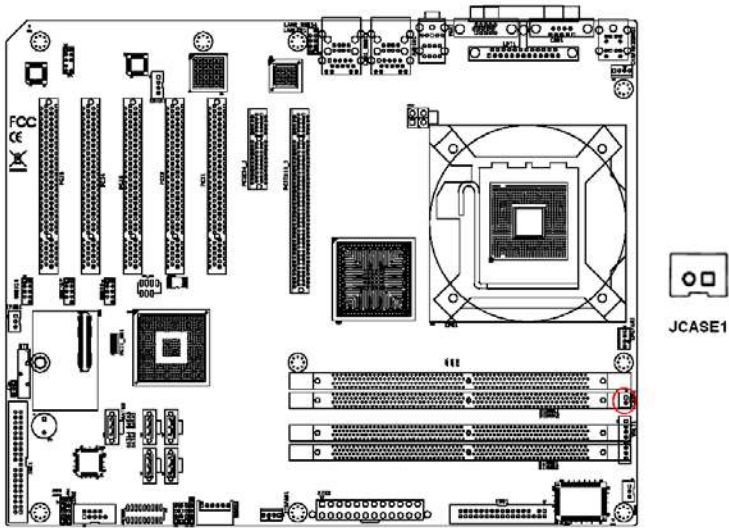

JCASE1 is for chassis with a case open sensor. The buzzer on the motherboard sounds if the case is opened.

2.19 Front Panel LAN Indicator Connector (LANLED1)

Table 2.2: Front Panel LAN Indicator Connector

LAN Mode	Indicator
G-LAN Link ON	Green ON
G-LAN Active	Green Flash
G-LAN Link Off	Green OFF

2.20 Serial ATA Interface (SATA1, SATA2, SATA3, SATA4 & SATA5)

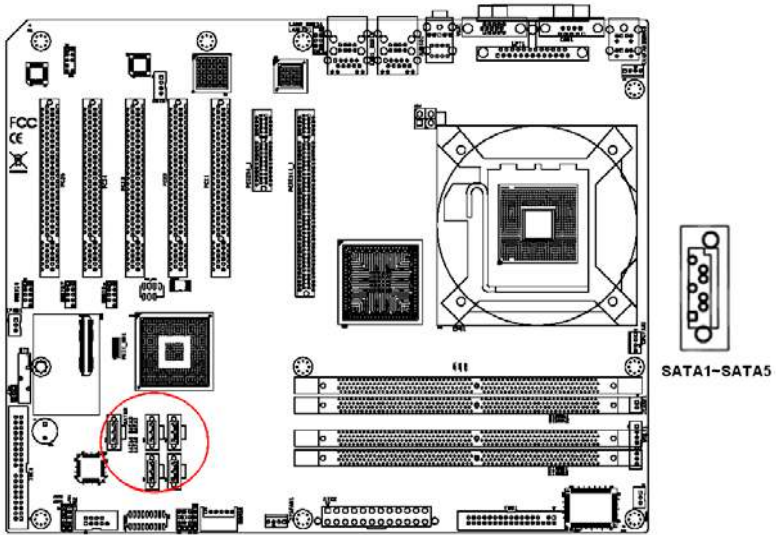

In addition to the IDE interface, the AIMB-764 features a high performance serial ATA interface (up to 300 MB/s) which eases cabling to hard drives with thin and long cables.

2.21 PCI Slots (PCI 1 ~ PCI 5)

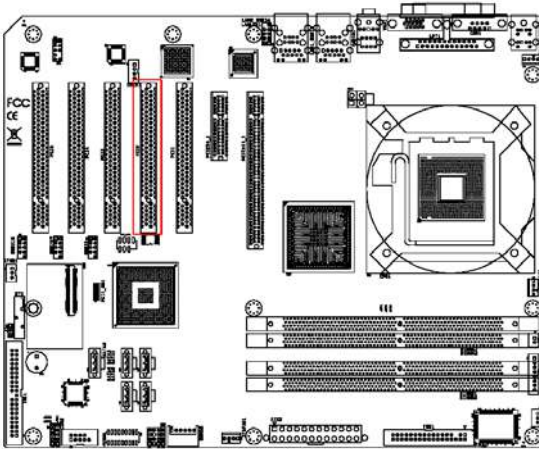

The AIMB-764 provides five 32-bit / 33 MHz PCI slots.

Note: *64-bit PCI or PCI-X expansion cards installed in the PCI 2 slots will not fit because of the south bridge heat sink. If you want to use 64-bit PCI or PCI-X expansion cards, please install them in the PCI 1, PCI 3, PCI 4 or PCI 5.*

2.22 PCIe x16 Expansion Slot (PCIe x16_1)

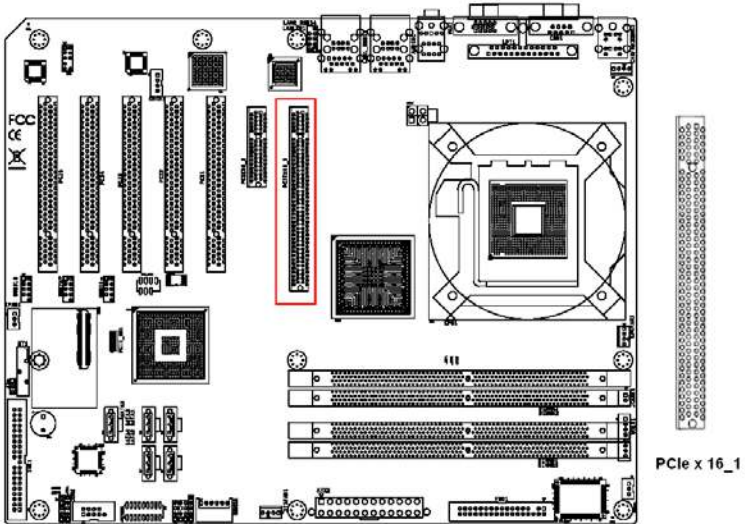

The AIMB-764 provides a PCIe x16 slot for users to install add-on VGA cards when their applications require higher graphics performance than the onboard graphics controller can provide.

2.23 PCIe x4 Expansion Slot (PCIe x4_1)

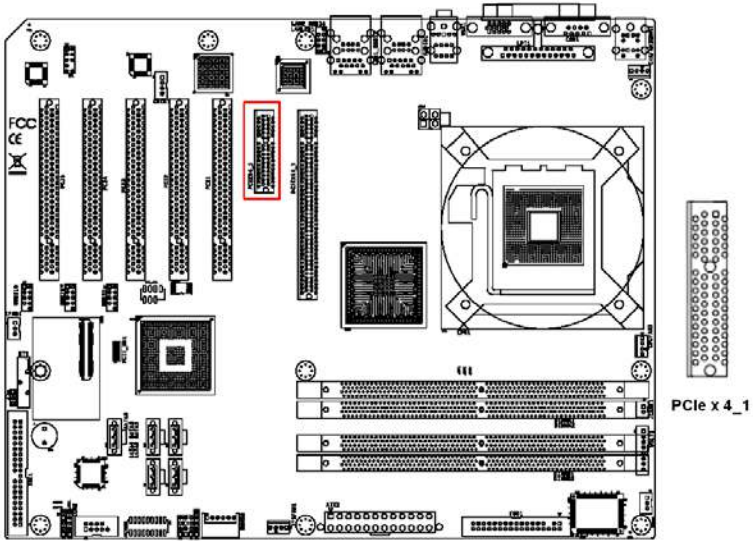

The AIMB-764 provides a PCIe x4 slot for users to install add-on cards.

2.24 Connecting to SNMP-1000 Remote Manager

Use the 6-pin to 8-pin cable to connect the motherboard to the SNMP-1000. This cable comes with the SNMP-1000.



2.25 Auxiliary 4-pin power connector (ATX1)

To ensure the enough power is supplied to the motherboard, one auxiliary 4-pin power connector is available on the AIMB-764. ATX1 must be used to provide sufficient 12 V power to ensure the stable operation of the system.

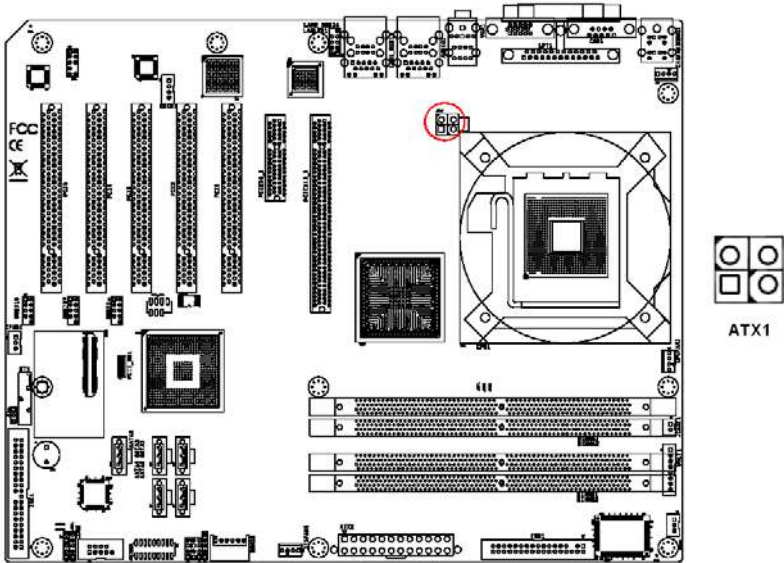

CHAPTER
3

Award BIOS Setup

Chapter 3 Award BIOS Setup

3.1 Introduction

3.1.1 BIOS Setup program

This motherboard supports a programmable firmware chip that you can update. Use the BIOS Setup program when you are installing a motherboard, reconfiguring your system, or prompted to “Run Setup”. This section explains how to configure your system using this utility.

Even if you are not prompted to use the BIOS Setup program, you can change the configuration of your computer in the future. For example, you can enable the security password feature or change the power management settings. This requires you to reconfigure your system using the BIOS Setup program so that the computer can recognize these changes and record them in the CMOS RAM of the SPI chip.

The firmware chip on the motherboard stores the BIOS Setup program. When you start up the computer, the system provides you with the opportunity to run this program. Press during the Power-On Self-Test (POST) to enter the Setup utility; otherwise, POST continues with its test routines.

If you wish to enter the BIOS Setup program after POST, reboot the system by doing any of the following procedures:

- Restart using the OS standard shut-down procedure.
- Press <Ctrl>+<Alt>+ simultaneously.
- Press the reset button on the system chassis.
- Press the power button to turn the system off then back on.

The BIOS Setup program is designed for ease-of-use. It is a menu-driven program that lets you browse the various submenus and make your selections from the available options using the navigation keys.

Caution! *Using the **power button, reset button** or the **<Ctrl>+<Alt>+** keys to force a reset from a running operating system can cause damage to your data or system. We recommend to always shut-down the system properly from the operating system.*

- Note:*
- 1. The default BIOS settings for this motherboard apply for most conditions to ensure optimum performance. If the system becomes unstable after changing any BIOS settings, load the default settings to ensure system compatibility and stability. Select the Load Setup Defaults item under the Exit Menu.*
 - 2. The BIOS setup screens shown in this section are for reference purposes only, and may not exactly match what you see on your screen.*
 - 3. Save a copy of the original motherboard BIOS file to a bootable floppy disk or a USB flash disk in case you need to restore the BIOS in the future.*

3.1.2 CMOS RAM Auto-backup and Restore

The CMOS RAM is powered by an onboard button cell battery. When you finish BIOS setup, the data in CMOS RAM will be automatically backed up to flash memory. If operation in harsh industrial environments causes a soft error, the BIOS will check the data in CMOS RAM and automatically restore the original data from flash memory to CMOS RAM for booting.

- Note:*
- To change the CMOS setting without restoring the previous backup, press “DEL” within two seconds of the “CMOS checksum error...” message appearing and then use the “Setup” screen to modify the configuration. If the “CMOS checksum error...” message appears again and again, please check to see if you need to replace the battery in your system.*

3.2 Entering Setup

Turn on the computer and press to enter the BIOS setup.

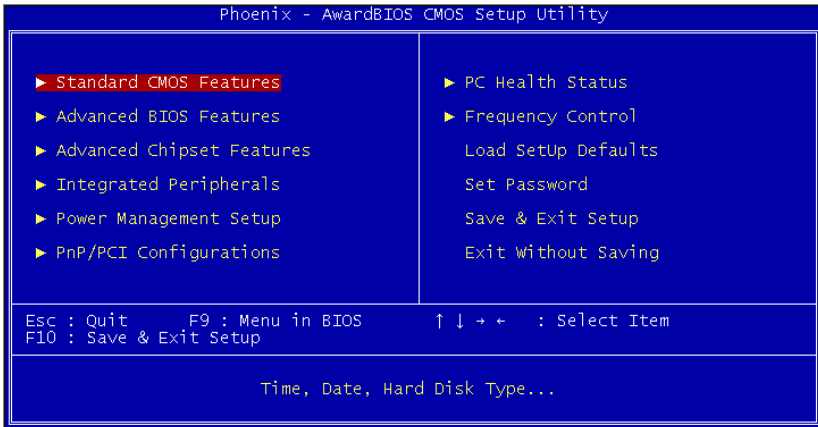

Figure 3.1: Award BIOS Setup initial screen

3.3 Standard CMOS Setup



Figure 3.2: Standard CMOS Features Screen

3.3.1 Date

The date format is:

<day of the week>, <month> <day of the month> <year>.

3.3.2 Time

The time format is <hour> : <minute> : <second>, based on the 24-hour clock.

3.3.3 IDE channel 0/1 Master/Slave

- **IDE HDD Auto-Detection:** Press “Enter” to select this option for automatic device detection.
- **IDE Device Setup:**
 - Auto:** Automatically detects IDE devices during POST
 - None:** Select this when no IDE device is used. The system will skip the auto-detection step to make system start up faster.
 - Manual:** Use this for manual configuration.
- **Access Mode:** The options are CHS/LBA/Large/Auto
- **Capacity:** Capacity of currently installed hard disk.
- **Cylinder:** Number of cylinders
- **Head:** Number of heads
- **Precomp:** Write precomp
- **Landing Zone:** Landing zone
- **Sector:** Number of sectors

3.3.4 Drive A / Drive B

This category identifies the types of floppy disk drives installed in the system. The options are: None/360K, 5.25"/1.2M, 5.25"/720K, 3.5"/1.44M, 3.5"/2.88M & 3.5".

3.3.5 Video

This category detects the type of adapter used for the primary system monitor that must match your video display card and monitor.

- **EGA / VGA:** Enhanced Graphics Adapter / Video Graphics Array. For EGA, VGA, SVGA or PGA adapters
- **CGA 40:** Color Graphics Adapter, power up in 40 column mode
- **CGA 80:** Color Graphics Adapter, power up in 80 column mode
- **MONO:** Monochrome adapter, includes high resolution monochrome adapters

3.3.6 Halt On

This category determines whether system start-up will halt or not when an error is detected during power up.

The options are: No Errors, All Errors, All But Keyboard, All But Diskette, All But Disk/Keyboard

3.3.7 Memory

This category displays base memory, extended memory, and total memory detected during POST (Power On Self Test).

3.4 Advanced BIOS Features

The “Advanced BIOS Features” screen appears when choosing the “Advanced BIOS Features” item from the “Initial Setup Screen” menu. It allows the user to configure the AIMB-764 according to his particular requirements. Below are some major items that are provided in the Advanced BIOS Features screen. A quick booting function is provided for your convenience. Simply enable the Quick Booting item to save yourself valuable time.

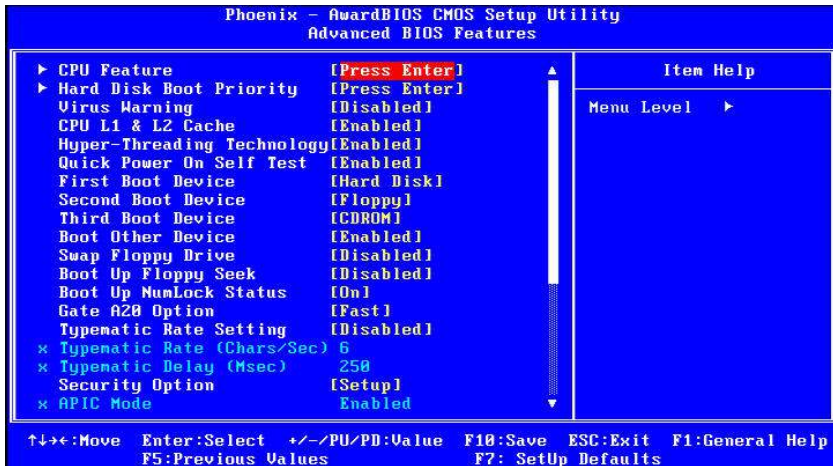

Figure 3.3: Advanced BIOS Features screen

3.4.1 CPU Features

Thermal Management

This feature controls the activation of the Thermal Monitor's automatic mode. It allows you to determine when the Pentium 4's Thermal Monitor should be activated in automatic mode after the system boots. For example, with the default value of 16 Minutes, the BIOS activates the Thermal Monitor in automatic mode 16 minutes after the system starts booting up. The choices are 4 Min, 8 Min, 16 Min and 32 Min.

Limit CPUID MaxVal

Set Limit CPUID MaxVal to 3. This should be disabled for Windows XP.

C1E Function:

This option sets the CPU C1E function.

Execute Disable Bit

When disabled, this option forces the XD feature flag to always return 0.

3.4.2 Hard Disk Boot Priority

This option sets hard disk boot device priority.

3.4.3 Virus Warning

Enables or disables the virus warning.

3.4.4 CPU L1, L2 & L3 Cache

Enabling this feature speeds up memory access. The commands are "Enabled" or "Disabled".

3.4.5 Hyper-Threading Technology

While using a CPU with Hyper-Threading technology, you can select "Enabled" to enable Hyper-Threading Technology in an OS that supports Hyper-Threading Technology or select "Disabled" for other OSs that do not support Hyper-Threading technology.

3.4.6 Quick Power On Self Test

This allows the system to skip certain tests to speed up the boot-up procedure.

3.4.7 First/Second/Third Boot Device

The BIOS tries to load the OS from the devices in the sequence set here. The options are: "Floppy", "LS120", "Hard disk", "CDROM", "ZIP100", "USB-FDD", "USB-ZIP", "USBCDROM", "USB-HDD", "LAN" and "Disabled".

3.4.8 Boot Other Device

Use this to boot another device. The options are “Enabled” and “Disabled”.

3.4.9 Swap Floppy Drive

If the system has two floppy drives, choose “Enabled” to assign physical drive B to logical drive A and vice-versa. The commands are “Enabled” or “Disabled”.

3.4.10 Boot Up Floppy Seek

Selection of the command “Disabled” will speed the boot up. Selection of “Enabled” searches for floppy disk drives during boot up.

3.4.11 Boot Up NumLock Status

Sets the boot up status Num Lock. The options are “On” and “Off”.

3.4.12 Gate A20 Option

“Normal”: A pin in the keyboard controller controls GateA20. Fast (Default) lets the chipset control GateA20.

3.4.13 Typematic Rate Setting

The typematic rate is the rate key strokes repeat as determined by the keyboard controller. The commands are “Enabled” or “Disabled”. Enabling allows the typematic rate and delay to be selected.

3.4.14 Typematic Rate (Chars/Sec)

The BIOS accepts the following input values (characters/second) for typematic rate: 6, 8, 10, 12, 15, 20, 24 and 30.

3.4.15 Typematic Delay (msec)

Typematic delay is the time interval between the appearances of two consecutive characters, when the key is continuously depressed. The input values for this category are: 250, 500, 750 and 1000 ms.

3.4.16 Security Option

This category determines whether the password is required when the system boots up or only when entering setup. The options are:

- **System:** The system will not boot, and access to Setup will be also denied unless the correct password is entered at the prompt.

- **Setup:** The system will boot, but access to Setup will be denied unless the correct password is entered at the prompt.

Note: To disable security, select **PASSWORD SETTING** in the main menu. You will be asked to enter a password. Press <Enter> to disable security. When security is disabled, the system will boot and you can enter Setup freely.

3.4.17 APIC Mode

This setting enables or disables the Advanced Configuration and Power Interface (ACPI) support in the Advanced Programmable Interrupt Controller (APIC).

3.5 Advanced Chipset Features

Choose the “Advanced Chipset Features” option from the “Initial Setup Screen” menu to show the following screen.

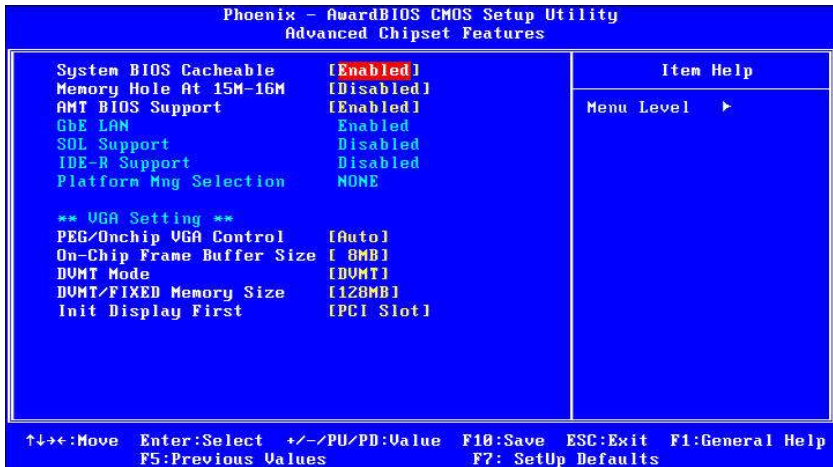

Figure 3.4: Advanced Chipset Features screen

Note: DRAM default timings have been carefully chosen and should ONLY be changed if data is being lost. Please contact technical support before changing these timings.

3.5.1 Memory Hole At 15M-16M

Enabling this feature reserves the 15 MB to 16 MB memory address space for ISA expansion cards that specifically require this setting. This makes memory from 15 MB and up unavailable to the system. Expansion cards can only access memory up to 16 MB. The default setting is “Disabled”.

3.5.2 Configure AMT BIOS Support (Intel Active Management Technology)

This option allows you to enable or disable the Intel AMT (Active Management Technology). Intel AMT is the next generation of network client management. Intel AMT is a set of advanced manageability features developed as a direct result of IT customer feedback gained through Intel market research. With the new implementation of System Defense in ICH8DO, the advanced manageability feature set of Intel AMT is further enhanced. Further details please browse Intel web site: www.intel.com.

Warning! *The Intel Active Management Technology requires the Intel AMT-enabled software. Also, the platform must be connected to a power source and an active LAN port.*

3.5.3 PEG / Onchip VGA Control

Use this field to select PEG or Onchip VGA. The default is AUTO.

3.5.4 On-Chip Frame Buffer Size

The On-Chip Frame Buffer Size can be set to 1 MB or 8 MB. This memory is shared with the system memory.

3.5.5 DVMT Mode

This option shows the active system memory mode.

3.5.6 DVMT / FIXED Memory Size

This option specifies the size of DVMT / FIXED system memory to allocate for video memory.

3.5.7 Init Display First

Choose the first display interface to initiate while booting. The choice is “PCI Slot” or “Onboard”.

3.6 Integrated Peripherals

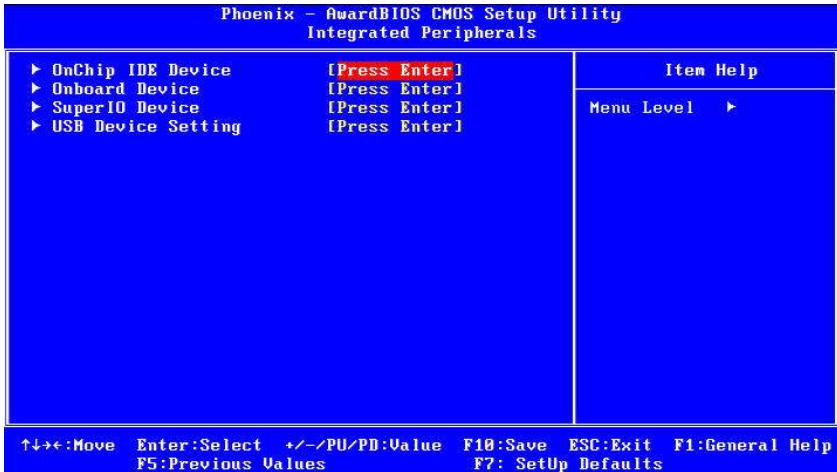

Figure 3.5: Integrated peripherals

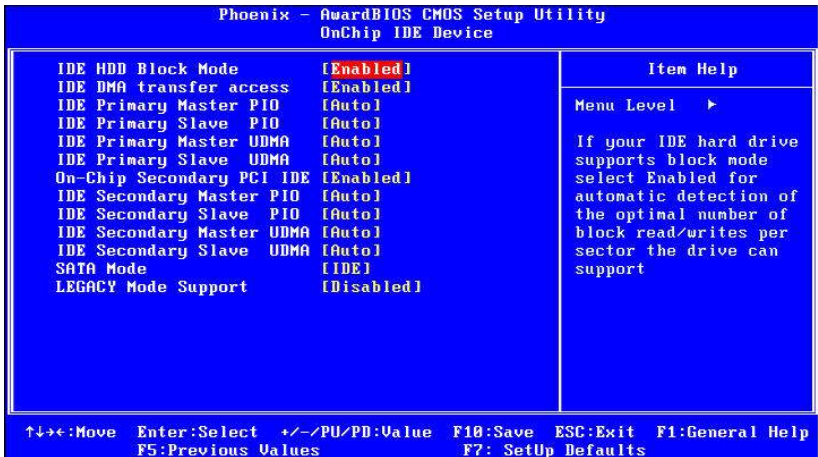

Figure 3.6: On-Chip IDE Device

3.6.1 IDE HDD Block Mode

If your IDE hard drive supports block mode, select Enabled to automatically detect the optimal number of block read/writes per sector that the drive can support.

3.6.2 IDE DMA Transfer Access

Use this field to enable or disable IDE DMA transfer access.

3.6.3 IDE Primary Master/Slave PIO/UDMA Mode (Auto)

Each IDE channel has both a master and a slave, making four IDE devices possible. Because two IDE devices may have a different Mode timings (0, 1, 2, 3, 4), it is necessary for these to be independent. The default setting “Auto” will allow auto detection to ensure optimal performance.

3.6.4 SATA Mode

The SATA modes are IDE, RAID and AHCI Mode. Select [IDE] if you want to have SATA function as IDE. Select [AHCI] to enable the Advanced Host Controller Interface (AHCI) feature, with improved SATA performance and native command queuing. Select [RAID] to use SATA for RAID.

3.6.5 Legacy mode support

This allows a SATA system to support PATA mode. The choices are “Disabled” and “Enabled”.

Note: Please refer to the *Intel Matrix Storage Technology quick start guide* and the *Intel Matrix Storage Manager User's Manual* in the *MANUAL* folder of this CD to find out how to build and configure your RAID 0, 1, 10 or 5 system using Intel Matrix Storage Technology and Matrix Storage Manager.

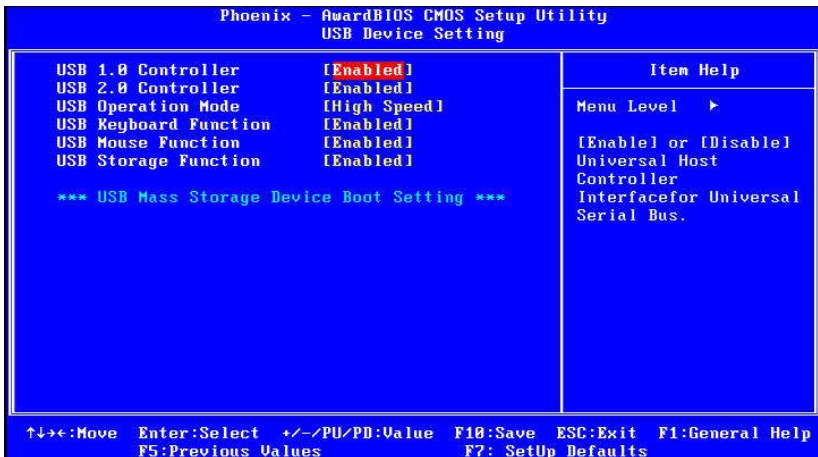

Figure 3.7: USB device setting

3.6.6 USB 1.0 Controller

Select Enabled if your system contains a Universal Serial Bus (USB) controller and you have USB peripherals. The choices are “Enabled” and “Disabled”.

3.6.7 USB Operation mode

Set the USB 2.0 controller to Hi Speed (480 Mbps) or Full Speed (12 Mbps).

3.6.8 USB storage function

Select Enabled if you plan to use an external USB storage device to boot DOS. The choices are “Enabled” and “Disabled”.

3.6.9 USB 2.0 Controller

Use this option to disable or enable the USB 2.0 controller. The BIOS may or may not have high speed USB support. If the BIOS has built-in high speed USB support, the support will automatically turn on when a high speed device is attached. The choices are “Enabled” or “Disabled”.

3.6.10 USB Keyboard / Mouse Support

Select Enabled if you plan to use an USB keyboard. The choices are “Enabled” and “Disabled”.



Figure 3.8: Onboard Device

3.6.11 On board LAN1 ROM

The options are “Enabled” and “Disabled”. Select “Disabled” if you don’t want to use the onboard LAN1 option ROM.

3.6.12 Onboard LAN2 Control

The options are “Enabled” and “Disabled”. Select “Disabled” if you don’t want to use the onboard LAN2 controller.

3.6.13 On board LAN2 ROM

The options are “Enabled” and “Disabled”. Select “Disabled” if you don’t want to use the onboard LAN2 option ROM.



Figure 3.9: Super I/O Device

3.6.14 Onboard FDC Controller

When enabled, this field allows you to connect your floppy disk drives to the onboard floppy disk drive connector instead of a separate controller card. If you want to use a different controller card to connect the floppy disk drives, set this field to Disabled.

3.6.15 Onboard Serial Port 1

The settings are “3F8/IRQ4”, “2F8/IRQ3”, “3E8/IRQ4”, “2E8/IRQ3”, and “Disabled”.

3.6.16 Onboard Serial Port 2

The settings are “3F8/IRQ4”, “2F8/IRQ3”, “3E8/IRQ4”, “2E8/IRQ3”, and “Disabled”.

3.6.17 UART Mode Select

This item allows you to select UART mode. The choices: “IrDA”, “ASKIR” and “Normal”.

3.6.18 RxD, TxD Active

This item allows you to determine the active level of the RxD and TxD serial lines. The choices are “Hi, Hi”, “Lo, Lo”, “Lo, Hi” and “Hi, Lo”.

3.6.19 IR Transmission Delay

This item allows you to enable or disable the IR transmission delay.

3.6.20 UR2 Duplex Mode

This item allows you to select the IR half/full duplex function. The choices are “Half” and “Full”.

3.6.21 Use IR Pins

The choices are “RxD2, TxD2” and “IR-Rx2Tx2”.

3.6.22 Onboard Parallel Port

This field sets the address of the onboard parallel port connector. You can select “378/IRQ7”, “278/IRQ5”, “3BC/IRQ7” or “Disabled”. If you install an I/O card with a parallel port, make sure there is no conflict in the address assignments. This motherboard can support up to three parallel ports.

3.6.23 Parallel Port Mode

This field allows you to set the operation mode of the parallel port. The setting “Normal” allows normal speed operation, but in one direction only. “EPP” allows bidirectional parallel port operation at maximum speed. “ECP” allows the parallel port to operate in bidirectional mode and at a speed faster than the maximum data transfer rate. “ECP + EPP” allows normal speed operation in bidirectional mode.

3.6.24 EPP Mode Select

This field allows you to select EPP port type 1.7 or 1.9.

3.6.25 ECP Mode Use DMA

This selection is available only if you select “ECP” or “ECP + EPP” in the Parallel Port Mode field. In ECP Mode, you can select DMA channel 1 or DMA channel 3. Leave this field on the default setting.

3.7 Power Management Setup

Power Management Setup controls the “green” power-saving features. The following screen shows the manufacturer’s defaults.

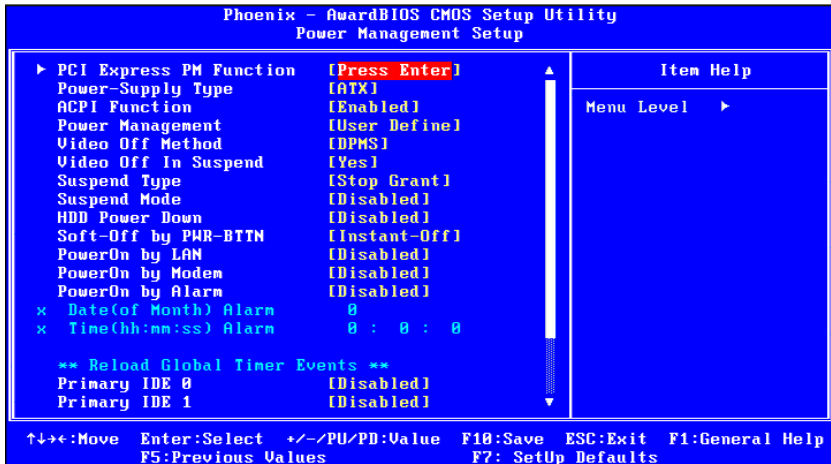

Figure 3.10: Power management setup screen

3.7.1 Power Supply Type

AIMB-764 can support both “ATX” and “AT” power supplies. Customers can choose the PSU type through this selection. The choices are “ATX” and “AT”.

3.7.2 ACPI Function

The choices are “Enabled” and “Disabled”.

3.7.3 ACPI Suspend Type

This item allows you to set ACPI suspend type to S1/POS (Power On Suspend).

3.7.4 Power Management

This category allows you to select the type (or degree) of power saving and is directly related to the following modes:

- HDD Power Down
- Suspend Mode

There are three selections for Power Management, and they have fixed mode settings.

Table 3.1: Power Saving

Saving Mode	Function
Min Saving	Minimum power management, Suspend Mode = 1 hr., and HDD Power Down = 15 min.
Max Saving	Maximum power management, Suspend Mode = 1 min., and HDD Power Down = 1 min.
User Defined (Default)	Allows you to set each mode individually. When not disabled, each of the ranges are from 1 min. to 1 hr. except for HDD Power Down which ranges from 1 min. to 15 min., and disabled.

3.7.5 Video Off Method

Use this to select the method to turn off the video. The choices are “Blank Screen”, “V/H SYNC+ Blank” and “DPMS”.

3.7.6 Video Off In Suspend

When the system is in suspend mode, the video will turn off. The choices are “No” and “Yes”.

3.7.7 Suspend Type

The choices are “Stop Grant” and “PwrOn Suspend”.

3.7.8 Suspend Mode

Please refer to 3.7.5.

3.7.9 HDD Power Down

Please refer to 3.7.5.

3.7.10 Soft-Off by PWR-BTTN

If you choose “Instant-Off”, then pushing the ATX soft power switch button once will switch the system to “system off” power mode. If you choose “Delay 4 sec” then pushing the ATX soft power button for more than 4 seconds will turn off the system, whereas pushing the button for less than 4 seconds will switch the system to “suspend” mode.

3.7.11 PowerOn by LAN

This item allows you to power on the system via the LAN. The choices are “Enabled” and “Disabled”.

3.7.12 PowerOn by Modem

To enable or disable the function to power on the system via a Modem connection from a remote host. The choices are “Enabled” and “Disabled”.

3.7.13 PowerOn by Alarm

The choices are “Enabled” and “Disabled”. The fields that follow, indicate the date and time that the alarm is set for, if enabled.

3.7.14 Primary IDE 0 (1) and Secondary IDE 0 (1)

When Enabled, the system will resume from suspend mode if Primary IDE 0 (1) or Secondary IDE 0 (1) becomes active. The choices are “Enabled” and “Disabled”.

3.7.15 FDD, COM, LPT PORT

When Enabled, the system will resume from suspend mode if the FDD, interface, COM port or LPT port is active. The choices are “Enabled” and “Disabled”.

3.7.16 PCI PIRQ [A-D]#

When enabled, the system resumes from suspend mode if an interrupt occurs. The choices are “Enabled” and “Disabled”.

3.7.17 PWRON After PWR-Fail

Use this to set up the system after power failure. The “Off” setting keeps the system powered off after power failure. The “On” setting boots up the system after failure.

3.8 PnP/PCI Configurations

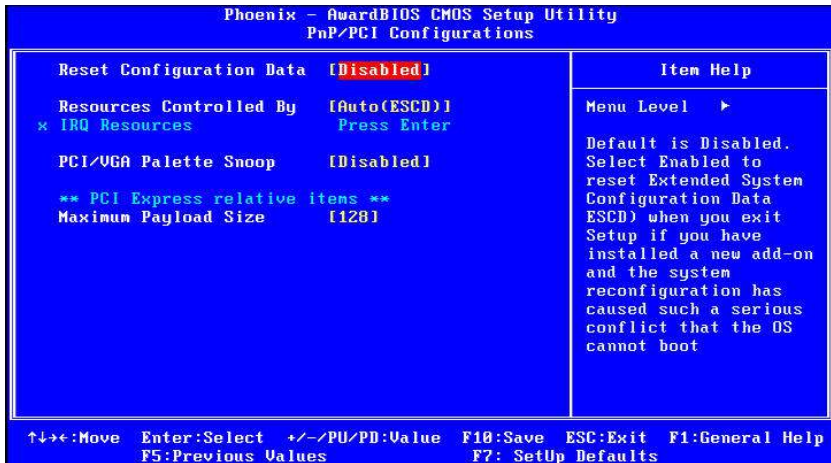

Figure 3.11: PnP/PCI configurations screen

3.8.1 Reset Configuration Data

The default is Disabled. Select Enabled to reset Extended System Configuration Data (ESCD) if you have installed a new add-on card, and system configuration is in such a state that the OS cannot boot.

3.8.2 Resources Controlled By

The commands here are “Auto(ESCD)” or “Manual”. Choosing “Manual” requires you to choose resources from the following sub-menu. “Auto(ESCD)” automatically configures all of the boot and Plug and Play devices, but you must be using Windows 95 or above.

3.8.3 PCI / VGA Palette Snoop

This is set to “Disabled” by default.

3.8.4 Maximum Payload Size

This allows you to set the maximum TLP payload size for PCIe devices. The options are [128 bytes].

3.9 PC Health Status

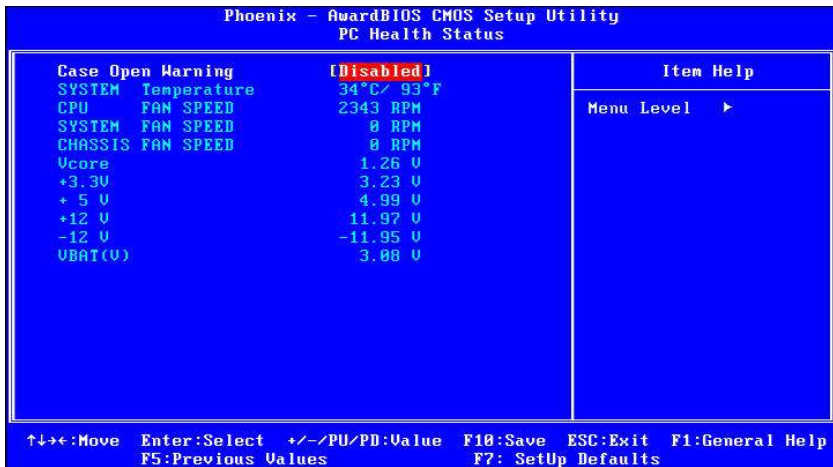

Figure 3.12: PC Health Status Screen

3.9.1 Case Open Warning

Enable this to detect if the case is open or closed.

3.9.2 Current System Temperature

This shows you the current temperature of system.

3.9.3 CPU FAN Speed

This shows the current CPU fan speed.

3.9.4 System FAN Speed

This shows the current system fan speed.

3.9.5 VCORE and Other Voltages

This shows the voltage of the VCORE, +3.3 V, +5 V, +12 V, -12 V and VBAT(V) power lines.

3.10 Frequency / Voltage Control

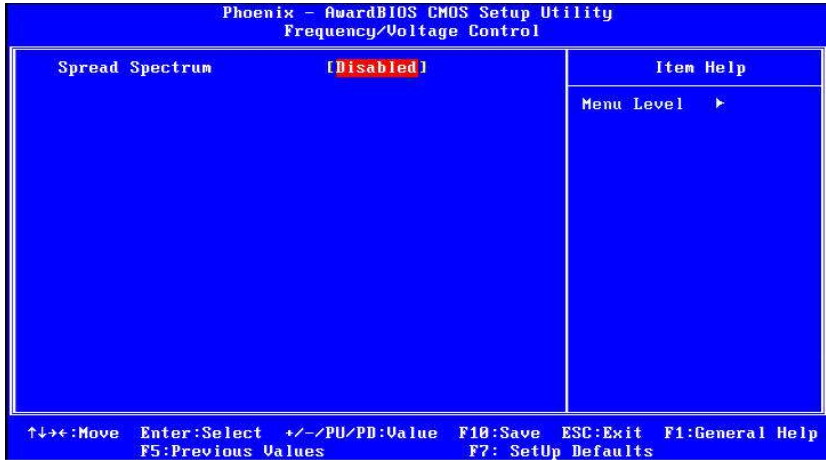

Figure 3.13: Spread Spectrum Frequency/Voltage Control screen

3.10.1 Spread Spectrum

This setting allows you to reduce EMI by modulating the signals the CPU generates so that the spikes are reduced to flatter curves. This is achieved by varying the frequency slightly so that the signal does not use any particular frequency for more than a moment. The choices are “Disabled” and “Enabled”.

3.11 Password Setting

Follow these steps to change the password.

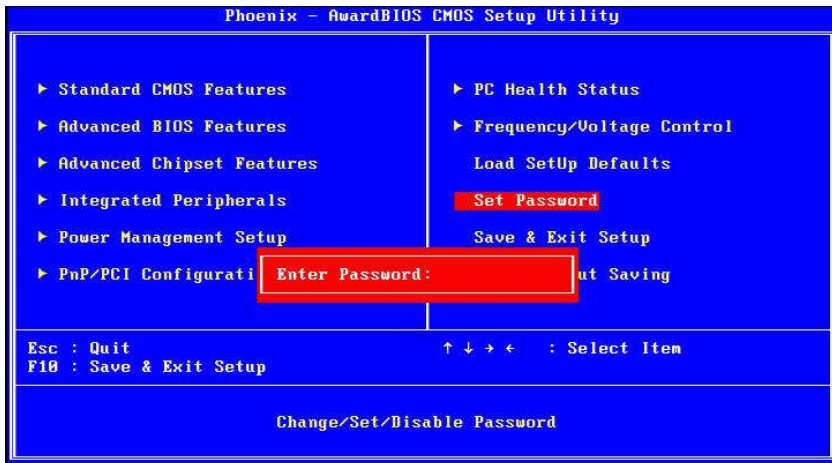

1. Choose the “Set Password” option from the “Initial Setup Screen” menu and press <Enter>. The screen displays the following message:

Please Enter Your Password

2. Press <Enter>.
3. If the CMOS is good and this option has been used to change the default password, the user is asked for the password stored in the CMOS. The screen displays the following message:

Please Confirm Your Password

4. Type the current password and press <Enter>.
5. After pressing <Enter> (ROM password) or the current password (user-defined), you can change the password stored in the CMOS. The password must be no longer than eight (8) characters. Remember, to enable the password setting feature, you must first select either “Setup” or “System” from the “Advanced BIOS Features” menu.

3.12 Save & Exit Setup

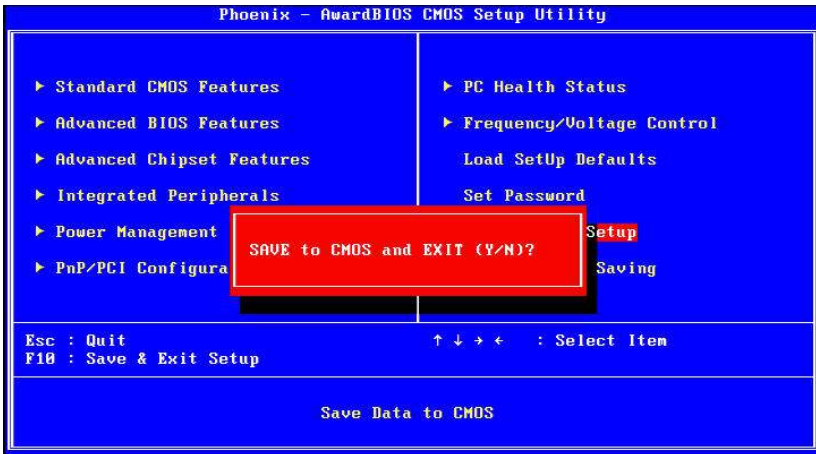

If you select this and press <Enter>, the values entered in the setup utilities will be recorded in the CMOS memory of the chipset. The processor will check this every time you turn your system on and compare this to what it finds as it checks the system. This record is required for the system to operate.

3.13 Exit Without Saving

Selecting this option and pressing <Enter> lets you exit the setup program without recording any new values or changing old ones.

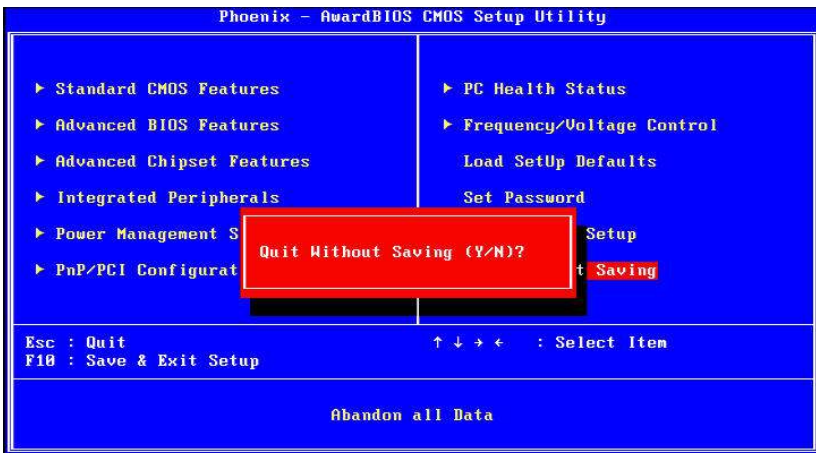

CHAPTER **4**

**Chipset Software
Installation Utility**

Chapter 4 Chipset Software Install Utility

4.1 Before you begin

To facilitate the installation of the enhanced display drivers and utility software, read the instructions in this chapter carefully. The drivers for the AIMB-764 are located on the software installation CD. The auto-run function of the driver CD will guide you to the utilities and drivers under a Windows system. The Intel Chipset Software Installation Utility is not required on any systems running Windows NT 4.0. Updates are provided via Service Packs from Microsoft.

Note: *The files on the software installation CD are compressed. Do not attempt to install the drivers by copying the files manually. You must use the supplied SETUP program to install the drivers.*

Before you begin, it is important to note that most display drivers need to have the relevant software application already installed in the system prior to installing the enhanced display drivers. In addition, many of the installation procedures assume that you are familiar with both the relevant software applications and operating system commands. Review the relevant operating system commands and the pertinent sections of your application software's user manual before performing the installation.

4.2 Introduction

The Intel Chipset Software Installation (CSI) utility installs the Windows INF files that outline to the operating system how the chipset components will be configured. This is needed for the proper functioning of the following features:

- Core PCI PnP services
- IDE Ultra ATA 100/66/33 and Serial ATA interface support
- USB 1.1/2.0 support (USB 2.0 driver needs to be installed separately for Windows 98)
- Identification of Intel chipset components in the Device Manager

- Integrates superior video features. These include filtered sealing of 720 pixel DVD content, and MPEG-2 motion compensation for software DVD playback

Note: *This utility is used for the following versions of Windows, and it has to be installed before installing all the other drivers:*

- Windows 2000
- Windows XP
- Windows Vista

4.3 Windows XP Driver Setup

1. Insert the driver CD into your system’s CD-ROM drive. In a few seconds, the software installation main menu appears. Move the mouse cursor over the “Install” button under the “INF Driver” heading. A message pops up telling you to install the CSI utility before other device drivers, as shown in the following figure. Click on this button. To take Windows XP as example.



2. Click “Next” when you see the following message.



3. Click “Yes” when you see the following message.



4. Click “Next” when you see the following message.



5. When the following message appears, click “Finish” to complete the installation and restart Windows.



CHAPTER
5

VGA Setup

Chapter 5 VGA Setup

5.1 Introduction

The Intel Q965 integrated graphics controller provides an analog display port and DVI interface through SDVO ports. You need to install the VGA driver to enable the function.

The Intel Q965 integrated graphics controller includes the following features.

- **Intel GMA 3000 GPU Integrated:** Incorporating the latest Microsoft DirectX 10 support capabilities, the Intel GMA 3000 GPU allows software developers to create lifelike environments and characters. Dual independent display, enhanced display modes for widescreen flat panels, and optimized 3D support deliver an intense and realistic visual experience without requiring a separate graphics card.
- **Intel Serial Digital Video Output (SDVO):** The AIMB-764 provides DVI interface through SDVO ports. It supports CRTs via a VGA connector with a maximum pixel clock of 400 MHz (up to 2048 x 1536 resolution @ 75 Hz refresh rate)

5.2 Windows XP Driver Setup

Note: Before installing this driver, make sure the INF driver has been installed in your system. See Chapter 4 for information on installing the INF driver.

Insert the driver CD into your system's CD-ROM drive. In a few seconds, the software installation main menu appears, as shown in the following figure.



The following installation procedure is for Windows XP.

1. Click “Next” to continue the installation.

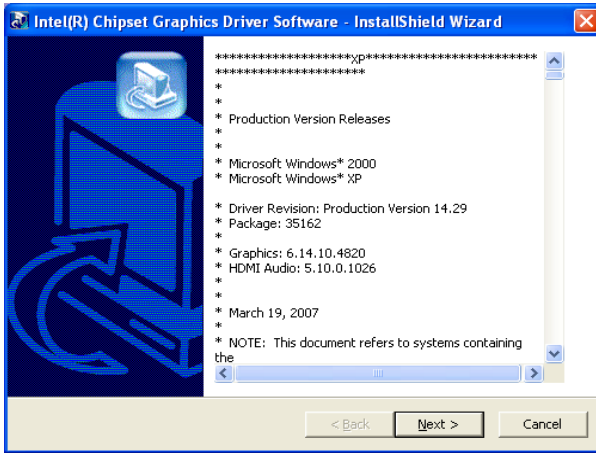

2. You will see a welcome window. Please click “Yes” to continue the installation.

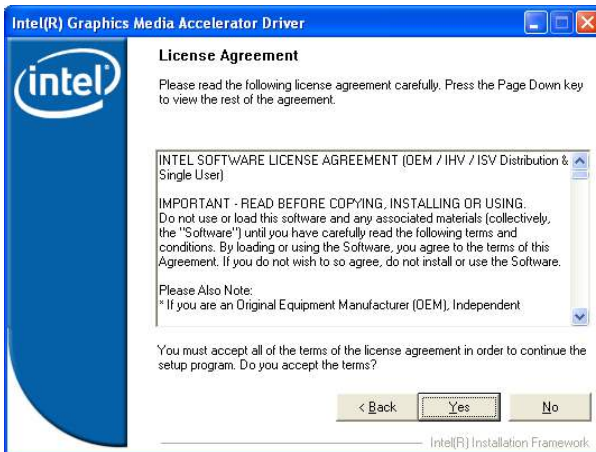

3. Click “Finish” to complete the installation and restart the computer now or later.

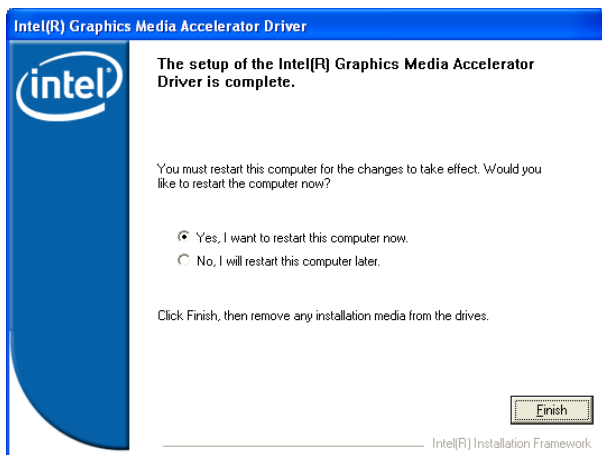

CHAPTER
6

**Onboard Security
Setup**

Chapter 6 Onboard Security Setup

6.1 Introduction

The AIMB-764's hardware monitor is based on the Winbond W83627HF chip. Onboard security (OBS) functions monitor key hardware to help you maintain system stability and durability. The AIMB-764 can monitor five sets of positive system voltages, two sets of system negative voltages, CPU cooling fan speed, and CPU temperature. The positive system voltages that can be monitored include:

- CPU core voltage: 1.3 ~ 3.3 V, according to Intel specifications.
- Transmission voltage from CPU to chipset: typically 1.8 V.
- Chipset voltage: typically 3.3 V.
- Main voltage: +5 V, +12 V.

6.2 Windows XP Driver Setup

1. Insert the driver CD into your system's CD-ROM drive. In a few seconds, the software installation main menu appears, as shown in the following figure. Click on the "Install" button under the "OB DRIVERS" heading.



2. Click “Next” when you see the following message.

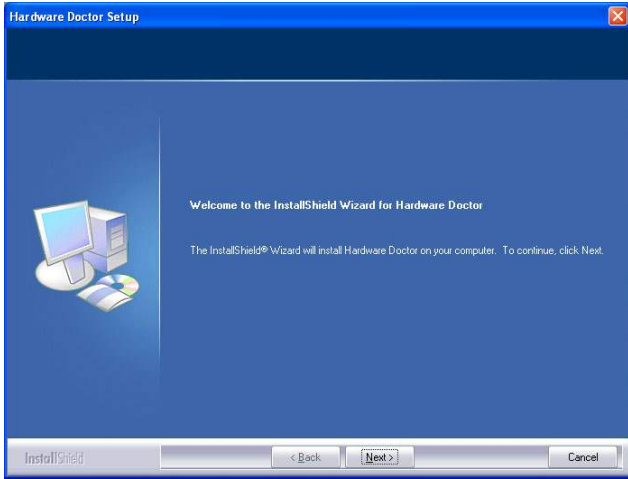

3. Click “Next” when you see the following message.

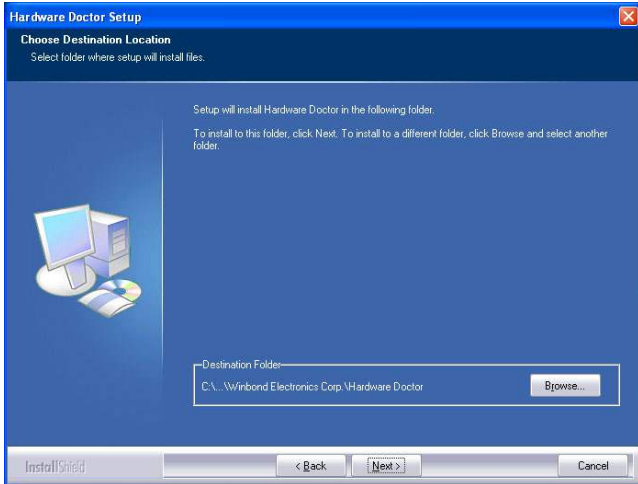

4. Click “Next” when you see the following message..

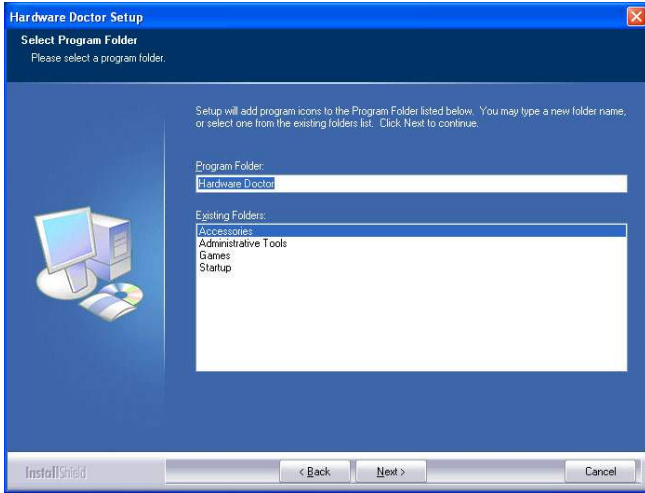

5. Click “Finish” when you see the following message.

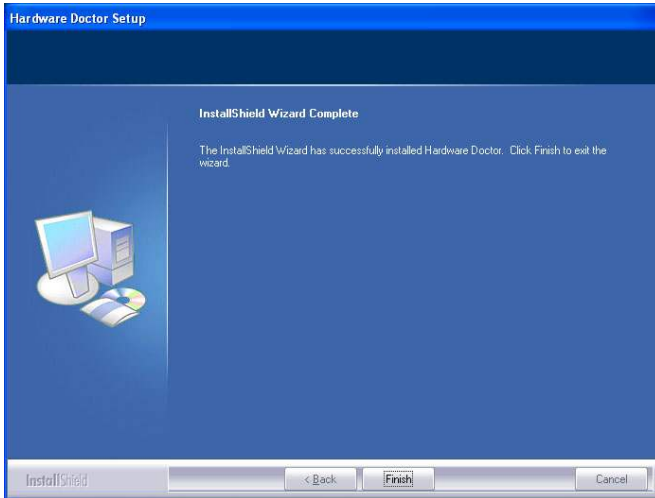

6.3 Using the OBS Hardware Doctor Utility

After completing the setup, all the OBS functions are permanently enabled. When a monitored reading exceeds safe limits, a warning message will be displayed and an error beep will sound to attract your attention.

OBS Hardware Doctor will show an icon on the right side of the bottom window bar. This icon is the “Terminate and Stay Resident” (TSR) icon. It will permanently remain in the bottom window bar, and will activate warning signals when triggered by the onboard security system.

You can view or change values for various OBS settings by following these steps.

From Windows desktop, click on “Start” and select “Programs”, select “Winbond HWDdoctor” and click “HWDDOCTOR”. It is recommended that you load the default values for all the OBS settings. However, if desired, you can establish new conditions for voltage, fan speed and temperature.

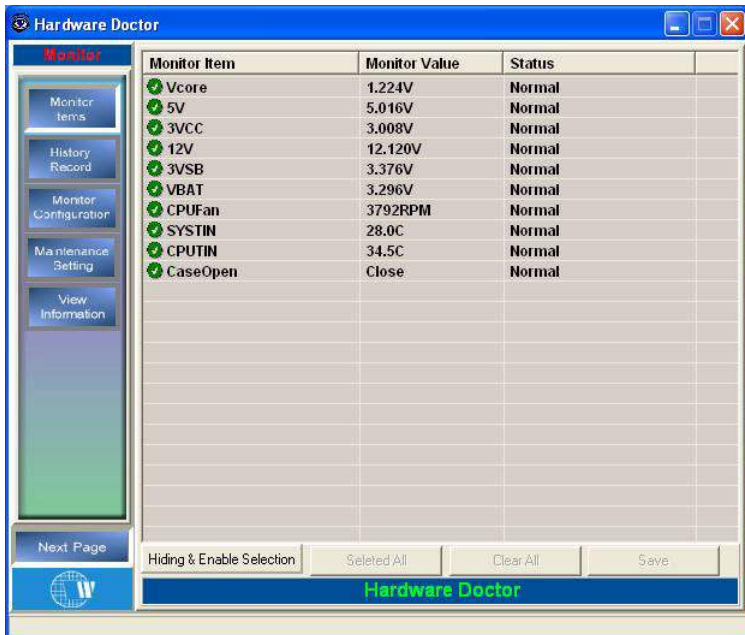

CHAPTER **7**

LAN Configuration

Chapter 7 LAN Configuration

7.1 Introduction

The AIMB-764 has a single/dual Gigabit Ethernet LAN interface that is connected to a dedicated PCIe x1 link to eliminating network bottlenecks by offering a bandwidth of up to 500 MB/s.

7.2 Features

- 10/100/1000Base-T Ethernet controller
- 10/100/1000Base-T triple-speed MAC
- High-speed RISC core with 24-KB cache
- On-chip voltage regulation
- Wake-on-LAN (WOL) support
- PCIe x1 host interface

7.3 Installation

Note: *Before installing the LAN drivers, make sure the INF Drivers have been installed on your system. See Chapter 4 for information on installing the INF Drivers.*

The integrated Intel gigabit Ethernet controller supports all major network operating systems. However, the installation procedure varies with different operating systems. In the following sections, refer to the one that provides the driver setup procedure for the operating system you are using.

7.4 Win XP Driver Setup (LAN)

1. Insert the driver CD into your system's CD-ROM drive. In a few seconds, the software installation main menu appears, as shown in the following figure. Click the appropriate operating system button under LAN Drivers.



2. You will see a welcome window. Click "Next" to continue the installation.

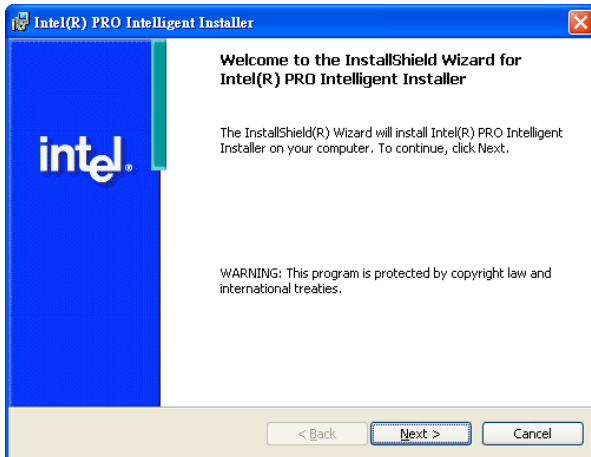

3. Click "Install Driver" to start the installation procedure.

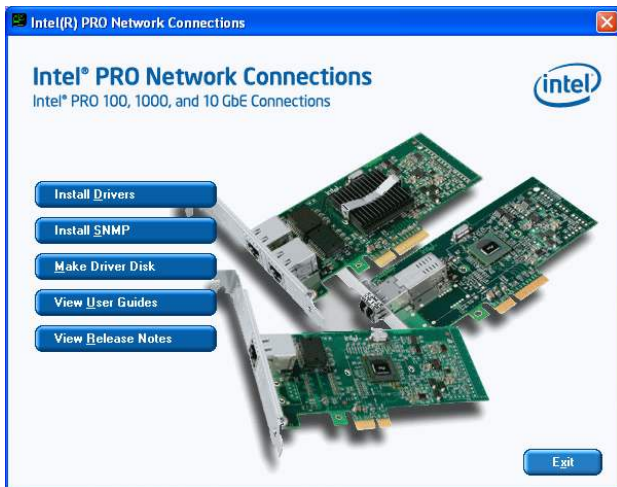

4. Click "Yes" to continue the installation.

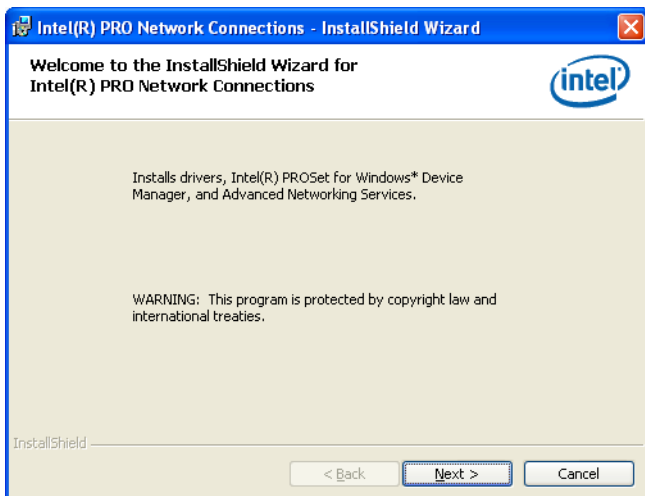

5. Select “I accept the terms in the license agreement” and click “Next” to continue.

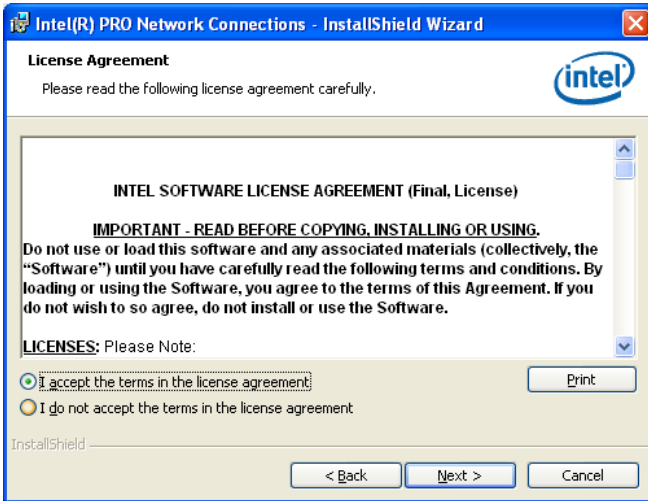

6. Select “Complete” and click “Next” to continue.

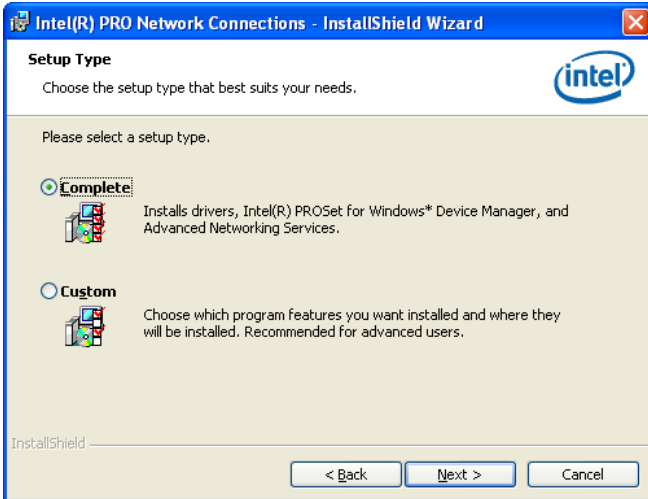

7. Click “Install” to begin the installation.

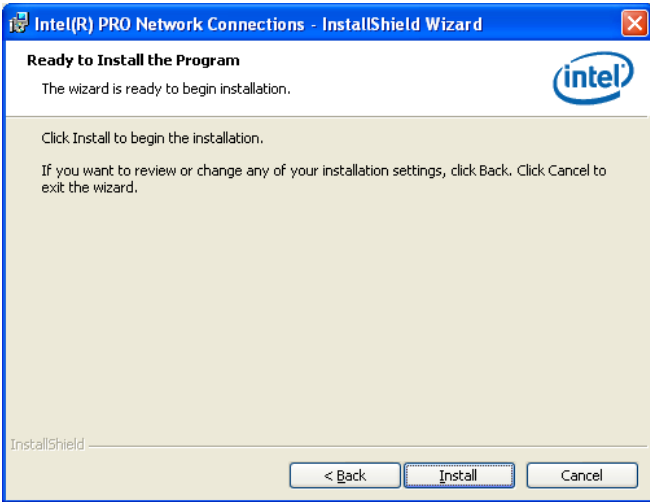

8. Click “Finish” to complete the installation.

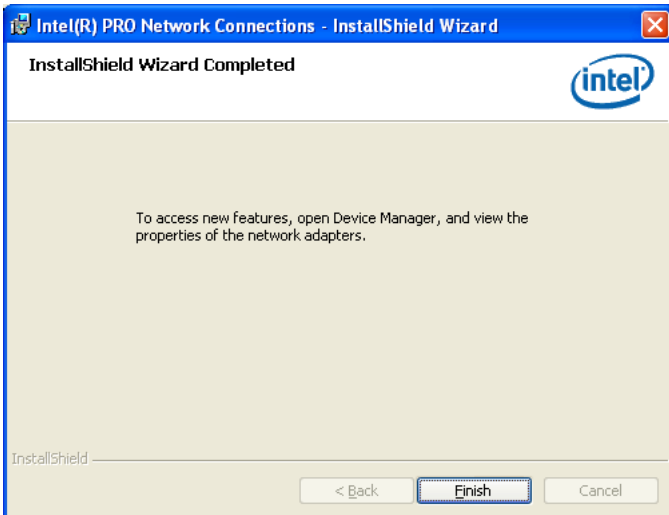

CHAPTER
8

AMT Setup

Chapter 8 AMT Setup

8.1 Intel AMT Overview

Intel Active Management Technology combines highly-available OOB remote management and network protection into an OS-independent and tamper-resistant solution to help address IT departments' top issues of network protection, asset management, and system reliability.

Features:

- Out-of-Band system access
- Remote trouble-shooting and recovery
- Proactive alerting
- Remote HW and SW asset tracking
- Third-party nonvolatile storage

Intel AMT is a comprehensive solution that includes software support from top-tier security and management software vendors

8.2 Windows XP Intel ME (Management Engine) Interface Setup

Note: Before installing this driver, make sure the INF Drivers have been installed in your system. See Chapter 4 for information on installing the INF Drivers.

Insert the driver CD into your system's CD-ROM drive. In a few seconds, the software installation main menu appears, as shown in the following figure.



The following installation procedure is for Windows XP. Currently, Vista drivers are not available.

1. You will see a welcome window. Click “Next” to continue the installation.



2. Please click “Yes” to continue the installation.

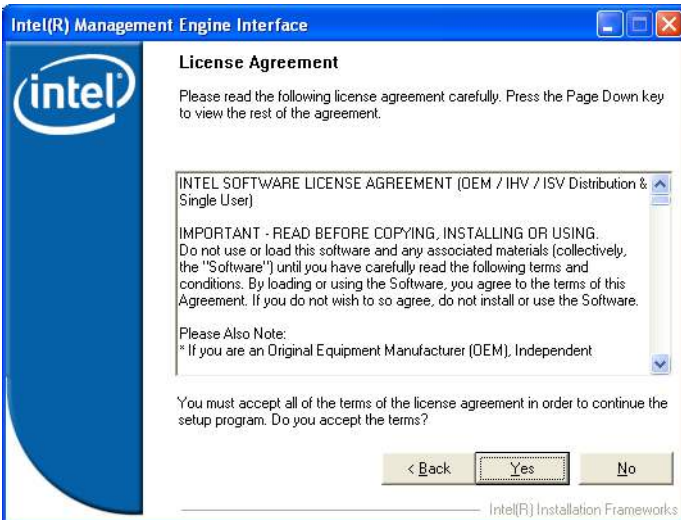

3. Please click “Next” to continue the installation.

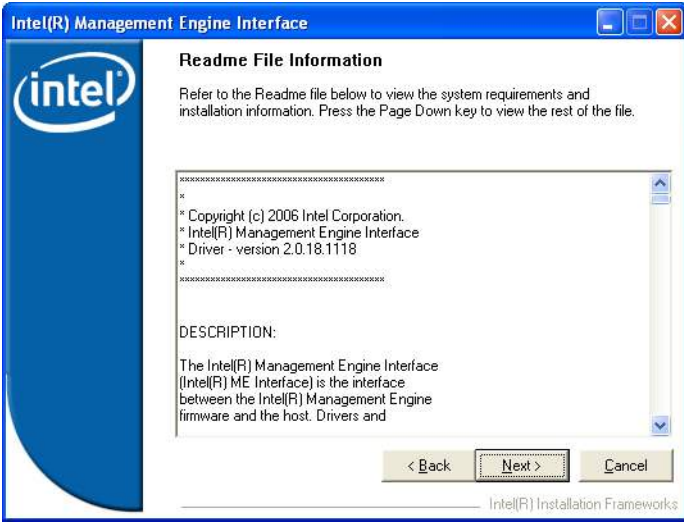

4. Please click “Next” to continue the installation.

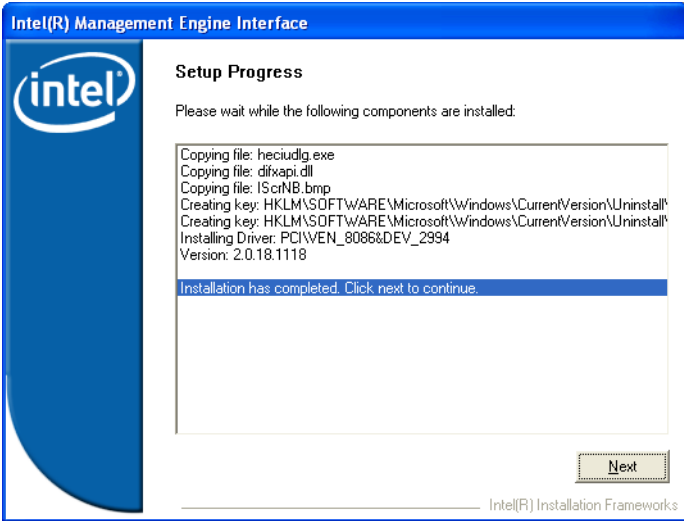

5. Click “Finish” to complete the installation. .

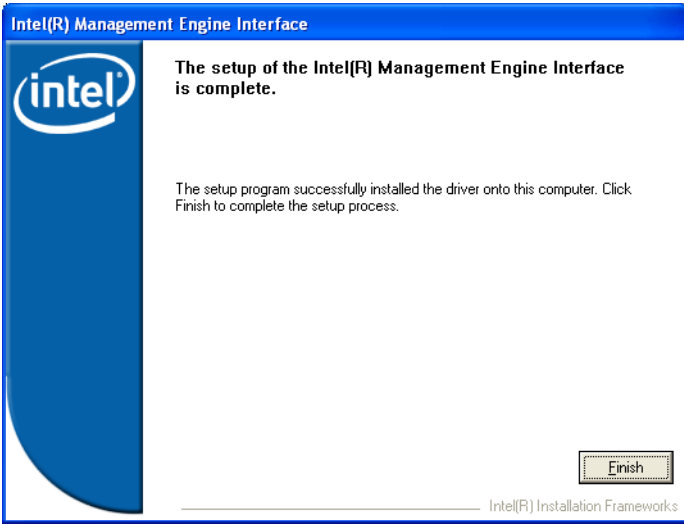

8.3 Windows XP AMT ME Driver Setup

1. You will see a welcome window. Click “Next” to continue the installation.

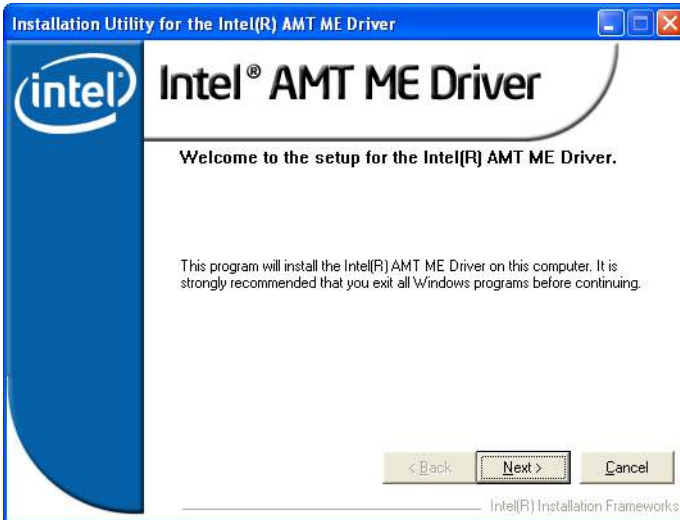

2. Please click “Yes” to continue the installation. .

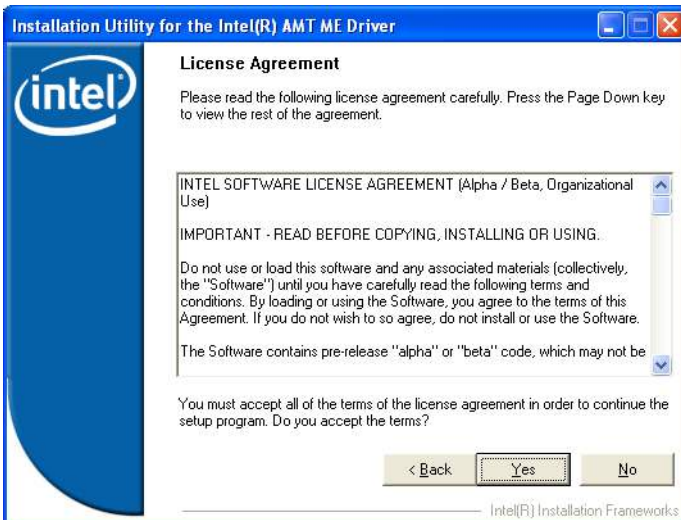

3. Please click “Next” to continue the installation.

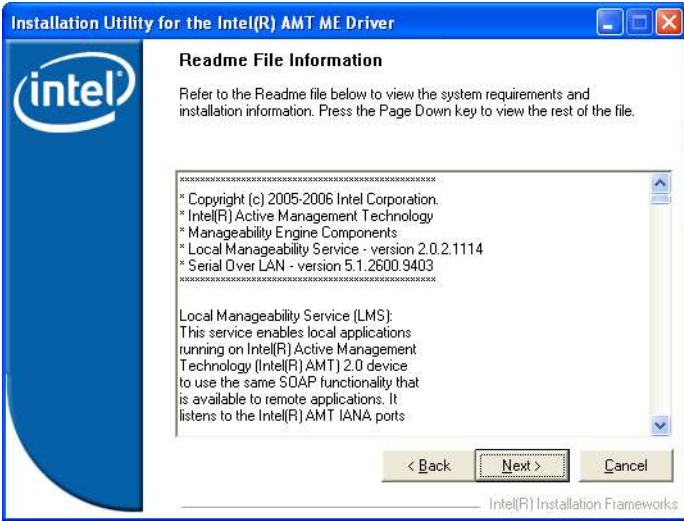

4. Please click “Next” to continue the installation.

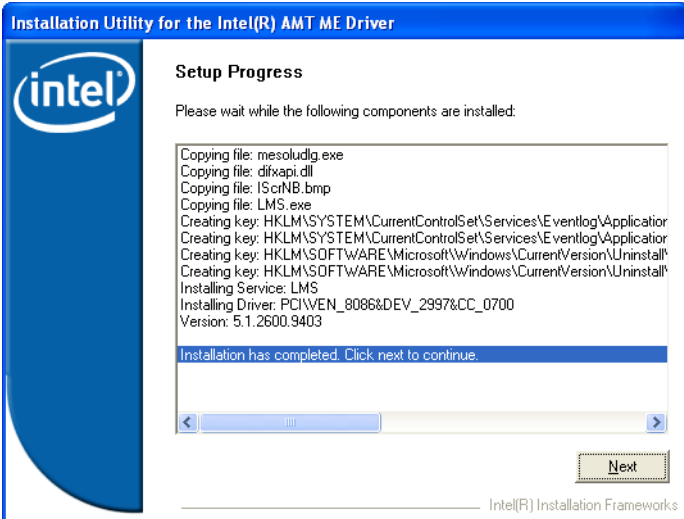

5. Click “Finish” to complete the installation. .

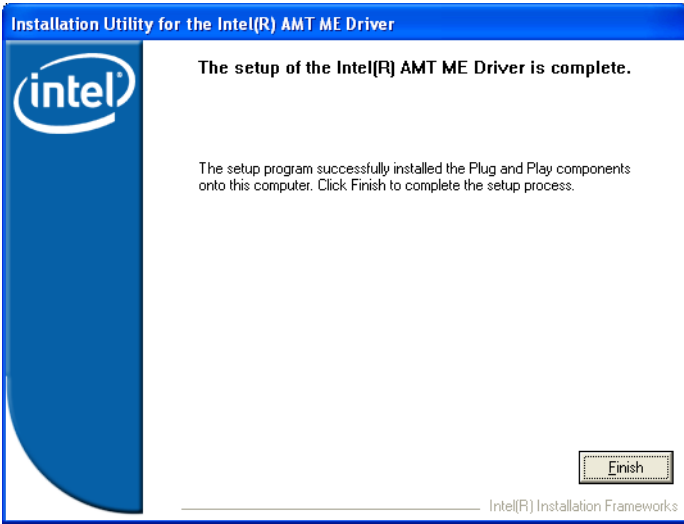

Appendix

A

Programming the Watchdog Timer

Appendix A Programming the Watchdog Timer

The AIMB-764's watchdog timer can be used to monitor system software operation and take corrective action if the software fails to function within the programmed period. This section describes the operation of the watchdog timer and how to program it.

A.1 Watchdog timer overview

The watchdog timer is built in to the super I/O controller W83627HG. It provides the following functions for user programming:

- Can be enabled and disabled by user's program
- Timer can be set from 1 to 255 seconds or 1 to 255 minutes
- Generates an interrupt or resets signal if the software fails to reset the timer before time-out

A.2 Programming the Watchdog Timer

The I/O port address of the watchdog timer is 2E (hex) and 2F (hex). 2E (hex) is the address port. 2F (hex) is the data port. You must first write an address value into address port 2E (hex), and then write/read data to/from the assigned register through data port 2F (hex).

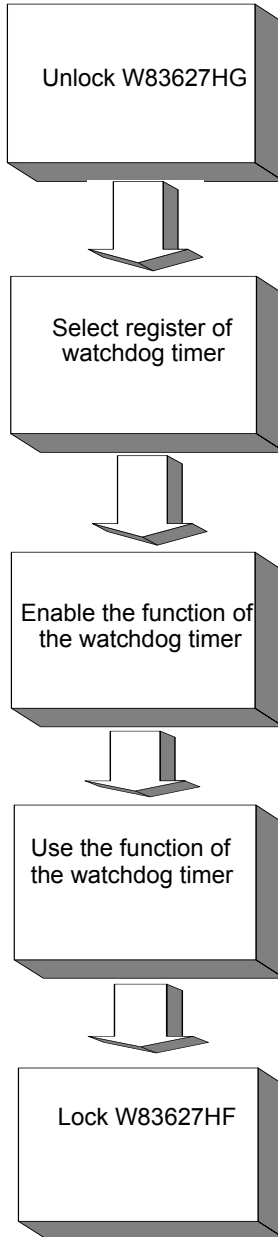

Table A.1: Watchdog timer registers

Address of register (2E)	Read/Write	Value (2F) & description
87 (hex)	----	Write this address to I/O address port 2E (hex) twice to unlock the W83627HF
07 (hex)	write	Write 08 (hex) to select register of watchdog timer.
30 (hex)	write	Write 01 (hex) to enable the function of the watchdog timer. Disabled is set as default.
F5 (hex)	write	Set seconds or minutes as units for the timer. Write 0 to bit 3: set seconds as counting unit. [default]. Write 1 to bit 3: set minutes as counting unit.
F6 (hex)	write	0: stop timer [default] 01 ~ FF (hex): The amount of the count, in seconds or minutes, depends on the value set in register F5 (hex). This number decides how long the watchdog timer waits for strobe before generating an interrupt or reset signal. Writing a new value to this register can reset the timer to count with the new value.
F7 (hex)	read/write	Bit 6: Write 1 to enable keyboard to reset the timer, 0 to disable.[default] Bit 5: Write 1 to generate a timeout signal immediately and automatically return to 0. [default=0] Bit 4: Read status of watchdog timer, 1 means timer is "timeout".
AA (hex)	----	Write this address to I/O port 2E (hex) to lock the watchdog timer 2.

A.2.1 Example Programs

Enable watchdog timer and set 10 seconds as the timeout interval

```

;-----
Mov dx,2eh      ; Unlock W83627HF
Mov al,87h
Out dx,al
Out dx,al
;-----

```

```

Mov al,07h          ; Select registers of watchdog timer
Out  dx,al
Inc  dx
Mov  al,08h
Out  dx,al
;-----
Dec dx              ; Enable the function of watchdog timer
Mov  al,30h
Out  dx,al
Inc  dx
Mov  al,01h
Out  dx,al
;-----
Dec dx              ; Set second as counting unit
Mov  al,0f5h
Out  dx,al
Inc  dx
In   al,dx
And  al,not 08h
Out  dx,al
;-----
Dec dx              ; Set timeout interval as 10 seconds and start counting
Mov  al,0f6h
Out  dx,al
Inc  dx
Mov  al,10
Out  dx,al
;-----
Dec dx              ; lock W83627HF
Mov  al,0aah
Out  dx,al

```

Enable watchdog timer and set 5 minutes as the timeout interval

```
;-----  
Mov dx,2eh      ; unlock W83627HF  
Mov al,87h  
Out dx,al  
Out dx,al  
;-----  
Mov al,07h      ; Select registers of watchdog timer  
Out dx,al  
Inc dx  
Mov al,08h  
Out dx,al  
;-----  
Dec dx          ; Enable the function of watchdog timer  
Mov al,30h  
Out dx,al  
Inc dx  
Mov al,01h  
Out dx,al  
;-----  
Dec dx          ; Set minute as counting unit  
Mov al,0f5h  
Out dx, al  
Inc dx  
In al,dx  
Or al, 08h  
Out dx,al  
;-----  
Dec dx          ; Set timeout interval as 5 minutes and start counting  
Mov al,0f6h  
Out dx,al
```

```
Inc dx
Mov al,5
Out dx,al
```

```
-----
```

```
Dec dx ; lock W83627HF
Mov al,0aah
Out dx,al
```

Enable watchdog timer to be reset by mouse

```
-----
```

```
Mov dx,2eh ; unlock W83627HF
Mov al,87h
Out dx,al
Out dx,al
```

```
-----
```

```
Mov al,07h ; Select registers of watchdog timer
Out dx,al
Inc dx
Mov al,08h
Out dx,al
```

```
-----
```

```
Dec dx ; Enable the function of watchdog timer
Mov al,30h
Out dx,al
Inc dx
Mov al,01h
Out dx,al
```

```
-----
```

```
Dec dx ; Enable watchdog timer to be reset by mouse
Mov al,0f7h
Out dx,al
Inc dx
```

```
In  al,dx
Or  al,80h
Out dx,al
```

```
-----
```

```
Dec dx          ; lock W83627HF
Mov  al,0aah
Out  dx,al
```

Enable watchdog timer to be reset by keyboard

```
-----
```

```
Mov dx,2eh      ; unlock W83627HF
Mov  al,87h
Out  dx,al
Out  dx,al
```

```
-----
```

```
Mov al,07h      ; Select registers of watchdog timer
Out  dx,al
Inc  dx
Mov  al,08h
Out  dx,al
```

```
-----
```

```
Dec dx          ; Enable the function of watchdog timer
Mov  al,30h
Out  dx,al
Inc  dx
Mov  al,01h
Out  dx,al
```

```
-----
```

```
Dec dx          ; Enable watchdog timer to be strobed reset by keyboard
Mov  al,0f7h
Out  dx,al
Inc  dx
```

```
In  al,dx
Or  al,40h
Out dx,al
```

```
-----
```

```
Dec dx          ; lock W83627HF
Mov  al,0aah
Out  dx,al
```

Generate a time-out signal without timer counting

```
-----
```

```
Mov dx,2eh      ; unlock W83627HF
Mov  al,87h
Out  dx,al
Out  dx,al
```

```
-----
```

```
Mov al,07h      ; Select registers of watchdog timer
Out  dx,al
Inc  dx
Mov  al,08h
Out  dx,al
```

```
-----
```

```
Dec dx          ; Enable the function of watchdog timer
Mov  al,30h
Out  dx,al
Inc  dx
Mov  al,01h
Out  dx,al
```

```
-----
```

```
Dec dx          ; Generate a time-out signal
Mov  al,0f7h
Out  dx,al      ; Write 1 to bit 5 of F7 register
Inc  dx
```

In al,dx

Or al,20h

Out dx,al

;------

Dec dx ; lock W83627HF

Mov al,0aah

Out dx,al

Appendix

B

I/O Pin Assignments

Appendix B Pin Assignments

B.1 IDE Hard Drive Connector (IDE1)

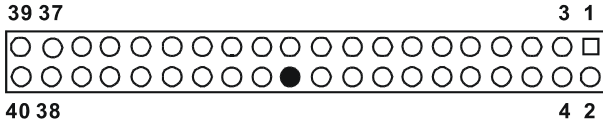

Table B.1: IDE hard drive connector (IDE1)

Pin	Signal	Pin	Signal
1	IDE RESET*	2	GND
3	DATA 7	4	DATA 8
5	DATA 6	6	DATA 9
7	DATA 5	8	DATA 10
9	DATA 4	10	DATA 11
11	DATA 3	12	DATA 12
13	DATA 2	14	DATA 13
15	DATA 1	16	DATA 14
17	DATA 0	18	DATA 15
19	SIGNAL GND	20	N/C
21	DISK DMA REQUEST	22	GND
23	IO WRITE	24	GND
25	IO READ	26	GND
27	IO CHANNEL READY	28	CSEL
29	HDACKO*	30	GND
31	IRQ14	32	NC
33	ADDR 1	34	PDIAG
35	ADDR 0	36	ADDR 2
37	HARD DISK SELECT 0*	38	HARD DISK SELECT 1*
39	IDE ACTIVE*	40	GND

* low activity

B.2 Floppy Drive Connector (FDD1)

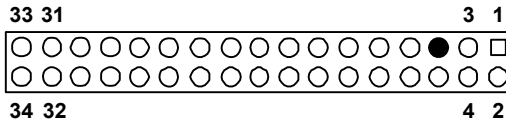

Table B.2: Floppy drive connector (FDD1)

Pin	Signal	Pin	Signal
1	GND	2	FDHDIN*
3	GND	4	N/C
5	N/C	6	FDEDIN*
7	GND	8	INDEX*
9	GND	10	MOTOR 0*
11	GND	12	DRIVE SELECT 1*
13	GND	14	DRIVE SELECT 0*
15	GND	16	MOTOR 1*
17	GND	18	DIRECTION*
19	GND	20	STEP*
21	GND	22	WRITE DATA*
23	GND	24	WRITE GATE*
25	GND	26	TRACK 0*
27	GND	28	WRITE PROTECT*
29	GND	30	READ DATA*
31	GND	32	HEAD SELECT*
33	GND	34	DISK CHANGE*

* low activity

B.3 Parallel Port (LPT1)

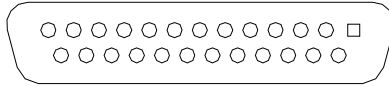

Table B.3: Parallel Port (LPT1)

Pin	Signal	Pin	Signal
1	STROBE*	14	AUTOFD*
2	D0	15	ERR
3	D1	16	INIT*
4	D2	17	SLCTINI*
5	D3	18	GND
6	D4	19	GND
7	D5	20	GND
8	D6	21	GND
9	D7	22	GND
10	ACK*	23	GND
11	BUSY	24	GND
12	PE	25	GND
13	SLCT	26	N/C

* low activity

B.4 USB Header (USB56,USB78,USB910)

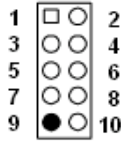

Table B.4: USB Header (USB56,USB78,USB910)

Pin	Signal	Pin	Signal
1	USB_VCC5	2	USB_VCC5
3	USB_D-	4	USB_D-
5	USB_D+	6	USB_D+
7	GND	8	GND
9	Key	10	GND

B.5 VGA Connector (VGA1)

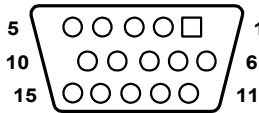

Table B.5: VGA Connector (VGA1)

Pin	Signal	Pin	Signal
1	RED	9	VCC
2	GREEN	10	GND
3	BLUE	11	N/C
4	N/C	12	SDT
5	GND	13	H-SYNC
6	GND	14	V-SYNC
7	GND	15	SCK
8	GND		

B.6 RS-232 Interface (COM1)

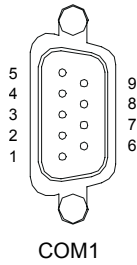
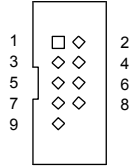

Table B.6: RS-232 Interface (COM1)

Pin	Signal
1	DCD
2	SIN
3	SOUT
4	DTR
5	GND
6	DSR
7	RTS
8	CTS
9	RI

B.7 RS-232/422/485 Interface (COM2)



COM2

Table B.7: RS-232 Interface (COM2)

Pin	Signal
1	DCD
2	DSR
3	SIN
4	RTS
5	SOUT
6	CTS
7	DTR
8	RI
9	GND

B.8 PS/2 Keyboard and Mouse Connector (KBMS1)



Table B.8: Keyboard & Mouse Connector (KBMS1)

Pin	Signal
1	KB DATA
2	N/C
3	GND
4	KB VCC
5	KB CLK
6	N/C

B.9 External Keyboard Connector (KBMS2)

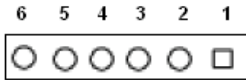

Table B.9: External Keyboard Connector (KBMS2)

Pin	Signal
1	KB CLK
2	KB DATA
3	MS DATA
4	GND
5	VCC
6	MS CLK

B.10 Infrared (IR) connector (JIR1)

Table B.10: Infrared Connector (JIR1)

Pin	Signal
1	VCC
2	N/C
3	IRRX
4	GND
5	IRTX

B.11 CPU/System Fan Power Connector (SYSFAN1/CHAFAN1)

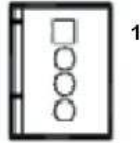

Table B.11: Fan Power Connector (SYSFAN1/CHAFAN1)

Pin	Signal
1	GND
2	+12V
3	DETECT
4	PWM

B.12 Power LED and Keyboard Lock (JFP3)

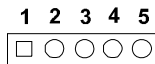

Table B.12: Power LED and Keyboard Lock (JFP3)

Pin	Function
1	LED power (+5 V)
2	NC
3	Ground
4	#keylock
5	Ground

B.13 External Speaker Connector (JFP2)

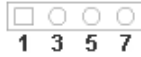

Table B.13: External Speaker Connector (JFP2)

Pin	Function
1	Buzzer
3	NC
5	Buzzer
7	Speaker out

B.14 Reset Connector (JFP1)



Table B.14: Reset Connector (JFP1)

Pin	Signal
3	RESET
4	GND

B.15 HDD LED Connector (JFP2)



Table B.15: HDD LED Connector (JFP2)

Pin	Signal
2	VCC
4	IDE/SATA

B.16 ATX Soft Power Switch (JFP1)



Table B.16: ATX Soft Power Switch (JFP1)

Pin	Signal
1	5VSB
2	PWR-BTN

B.17 H/W Monitor Alarm (JOBS1)



Table B.17: H/W Monitor Alarm (JOBS1)

Pin	Signal
1	Error Beep
2	OBS Beep alarm

B.18 SM Bus Connector (JFP2)



Table B.18: SM Bus Connector (JFP2)

Pin	Signal
6	SMB_DATA
8	SMB_CLK

B.19 USB/LAN ports (LAN1_USB12 and LAN2_USB34)

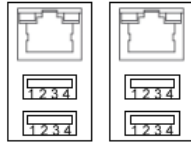

LAN1_USB12 LAN2_USB34

Table B.19: USB Port

Pin	Signal	Pin	Signal
1	VCC_DUAL	3	Data0+
2	Data0-	4	GND

Table B.20: 10/100/1000Base-T RJ-45 port

Pin	Signal	Pin	Signal
1	MID0+	5	MID2+
2	MID0-	6	MID2+
3	MID1+	7	MID3+
4	MID1-	8	MID3+

B.20 Line Out, Mic IN Connector (AUDIO1)

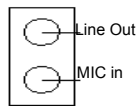

AUDIO1

B.21 Audio Input from CD-ROM (CDIN1)



Table B.21: Audio Input from CD-ROM

Pin	Signal	Pin	Signal
1	CD_L	3	GND
2	GND	4	CD_R

B.22 Front Panel Audio Connector (FP AUDIO; HD1)

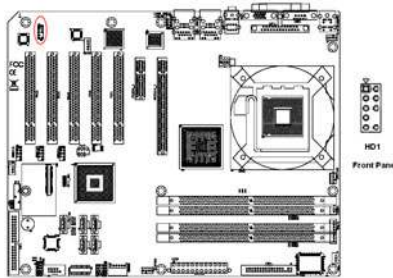
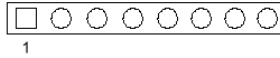

Table B.22: Audio Connector (FP AUDIO; HD1)

Pin	Signal	Pin	Signal
1	MIC2_L	2	Ground
3	MIC2_R	4	VCC3
5	LINEOUT2_R	6	Ground
7	FRONT_IO_JD	8	NC
9	LINEOUT2_L	10	Ground

B.23 8-pin Alarm Board Connector (VOLT1)



VOLT1

Table B.23: 8-pin Alarm Board Connector (VOLT1)

Pin	Signal	Pin	Signal
1	5VSB	5	VCC
2	GND	6	VCC3
3	GND	7	-12V
4	-5V	8	+12V

B.24 Case Open Connector (JCASE1)



Table B.24: Case Open Connector (JCASE1)

Pin	Signal
1	CASEOP
2	GND

B.25 Front Panel LAN LED Connector (LANLED1)

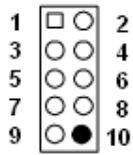

Table B.25: LAN LED Connector (LANLED1)

Pin	Signal	Pin	Signal
1	LAN1_LINK/ACT	2	LAN2_LINK/ACT
3	3VDUAL	4	3VDUAL
5	LAN1_LINK1000	6	LAN2_LINK1000
7	LAN1_LINK100	8	LAN2_LINK100
9	3VDUAL	10	N/C

B.26 System I/O Ports

Table B.26: System I/O ports

Addr. range (Hex)	Device
000-01F	DMA controller
020-021	Interrupt controller 1, master
022-023	Chipset address
040-05F	8254 timer
060-06F	8042 (keyboard controller)
070-07F	Real-time clock, non-maskable interrupt (NMI) mask
080-09F	DMA page register
0A0-0BF	Interrupt controller 2
0C0-0DF	DMA controller
0F0	Clear math co-processor
0F1	Reset math co-processor
0F8-0FF	Math co-processor
1F0-1F8	Fixed disk
200-207	Game I/O
278-27F	Parallel printer port 2 (LPT3)
290-297	On-board hardware monitor
2F8-2FF	Serial port 2
300-31F	Prototype card
360-36F	Reserved
378-37F	Parallel printer port 1 (LPT2)
380-38F	SDLC, bisynchronous 2
3A0-3AF	Bisynchronous 1
3B0-3BF	Monochrome display and printer adapter (LPT1)
3C0-3CF	Reserved
3D0-3DF	Color/graphics monitor adapter
3F0-3F7	Diskette controller
3F8-3FF	Serial port 1

B.27 DMA Channel Assignments

Table B.27: DMA channel assignments

Channel	Function
0	Available
1	Available
2	Floppy disk (8-bit transfer)
3	Available
4	Cascade for DMA controller 1
5	Available
6	Available
7	Available

B.28 Interrupt Assignments

Table B.28: Interrupt assignments

Priority	Interrupt#	Interrupt source
1	NMI	Parity error detected
2	IRQ0	Interval timer
3	IRQ1	Keyboard
-	IRQ2	Interrupt from controller 2 (cascade)
4	IRQ8	Real-time clock
5	IRQ9	Cascaded to INT 0A (IRQ 2)
6	IRQ10	Available
7	IRQ11	Available
8	IRQ12	PS/2 mouse
9	IRQ13	INT from co-processor
10	IRQ14	Primary IDE Channel
11	IRQ15	Secondary IDE Channel
12	IRQ3	Serial communication port 2
13	IRQ4	Serial communication port 1
14	IRQ5	Parallel port 2
15	IRQ6	Diskette controller (FDC)
16	IRQ7	Parallel port 1 (print port)

B.29 1st MB Memory Map

Table B.29: 1st MB memory map

Addr. range (Hex)	Device
E0000h - FFFFFh	BIOS
CC000h - DFFFFh	Unused
C0000h - CBFFFh	VGA BIOS
A0000h - BFFFFh	Video Memory
00000h - 9FFFFh	Base memory