

MAXIM

MAX3737 Evaluation Kit

General Description

The MAX3737 evaluation kit (EV kit) is an assembled demonstration board that provides complete optical and electrical evaluation of the MAX3737.

The EV kit is composed of two independent sections, one optical and one electrical, on the PC board. The output of the electrical evaluation section is interfaced to an SMP connector that can be connected to a 50Ω terminated oscilloscope. The output of the optical evaluation section is configured for attachment to a laser/monitor diode.

Features

- ◆ Fully Assembled and Tested
- ◆ Single +3.3V Power Supply Operation
- ◆ AC-Coupling Provided On-Board
- ◆ Allows Optical and Electrical Evaluation

Ordering Information

PART	TEMP RANGE	IC-PACKAGE
MAX3737EVKIT	-40°C to +85°C	32 Thin QFN

Electrical Evaluation Component List

DESIGNATION	QTY	DESCRIPTION
C6, C7, C14, C16, C39	5	0.01μF ±10% ceramic capacitors (0402)
C9, C11	2	0.01μF ±10% ceramic capacitors (0201)
C10	1	0.5pF ±10% ceramic capacitor (0201)
C1, C2, C15, C17, C19	5	0.1μF ±10% ceramic capacitors (0402)
C3, C4, C5, C12	4	470pF ±10% ceramic capacitors (0402)
C8	1	20pF ±10% ceramic capacitor (0402)
C18	1	10μF ±10% tantalum capacitor, case B
D2	1	Diode, DIO-S1A
D1	1	LED, red T1 package
J7	1	SMP connector, Tensolite P698-2CC
J1, J2	2	SMA connectors, round, Johnson 142-0701-801
JU1, JU7, JU8, JU10, JU11, JU14, JU15	7	2-pin headers, 0.1in centers
JU12, JU13	2	4-pin headers, 0.1in centers
JU2-JU5, JU9	5	3-pin headers, 0.1in centers
JU6	—	Short, 0201 solder bridge
VCC, GND, TP1-TP10, TP12, TP14	14	Test Points

DESIGNATION	QTY	DESCRIPTION
L1	—	Not installed
L2	1	1.2μH inductor (1008LS) Coilcraft 1008CS-122XKBC
Q3	1	MOSFET (SOT23) Fairchild FDN306P
Q1	1	NPN transistor (SOT23) Zetex FMMT491A
Q2	1	PNP transistor (SOT23) Zetex FMMT591A
R16, R17, R19, R23, R24, R29-R34, R41-R44	—	Not installed
R11	1	4.9Ω ±1% resistor (0402)
R12, R13, R14	3	30.1Ω ±1% resistors (0402)
R50	1	75Ω ±1% resistor (0402)
R15	1	10Ω ±1% resistor (0201)
R20-R22	3	10Ω ±1% resistor (0402)
R18	1	392Ω ±1% resistor (0402)
R10	1	511Ω ±1% resistor (0402)
R58	1	332Ω ±1% resistor (0402)
R61	1	3.32kΩ ±1% resistor (0402)
R8, R9	2	4.7kΩ ±1% resistor (0402)
R1, R2, R5, R6, R25, R28	6	100Ω ±1% resistor (0402)
R26	1	20kΩ variable resistors Bourns 3296W
R3, R4, R7, R27	4	50kΩ variable resistors Bourns 3296W

Evaluates: MAX3737

MAX3737 Evaluation Kit

Electrical Evaluation Component List (cont.)

DESIGNATION	QTY	DESCRIPTION
U1	1	MAX3737ETJ (32 Thin QFN)
U2	1	MAX495ESA (8 SO)
None	11	Shunts
None	1	MAX3737 EV board
None	1	MAX3737 data Sheet

Optical Evaluation Component List

DESIGNATION	QTY	DESCRIPTION
C23, C25, C28, C30-C33	7	0.01 μ F \pm 10% ceramic capacitors (0402)
C26, C29	2	0.01 μ F \pm 10% ceramic capacitors (0603)
C24*	1	8.2pF \pm 10% ceramic capacitor (0402)
C27, C34-36	4	470pF \pm 10% ceramic capacitors (0402)
C20, C22, C37, C38, C40	5	0.1 μ F \pm 10% ceramic capacitors (0402)
C21	1	10 μ F \pm 10% tantalum capacitor, case B
D3	—	Open, user-supplied laser
D4	1	LED, red T1 package
J4, J5	2	SMA connectors, round, Johnson 142-0701-801
JU16, JU20, JU30	3	2-pin headers, 0.1in centers
L4	1	600 Ω ferrite bead (0603) Murata BLM18HG601SN1
L3	1	1.2 μ H inductor (1008CS) Coilcraft 1008CS-122XKBC
Q4	1	MOSFET (SOT23) Fairchild FDN306P
Q6	1	NPN transistor (SOT23) Zetex FMMT491A

DESIGNATION	QTY	DESCRIPTION
R35-R38, R40, R45-R49	—	Not installed
R39*	1	49.9 Ω \pm 1% resistor (0402)
R54	1	10 Ω \pm 1% resistor (0402)
R56	1	15 Ω \pm 1% resistor (0402)
R59	1	511 Ω \pm 1% resistor (0402)
R60	1	4.7k Ω \pm 1% resistor (0402)
R62	1	3.32k Ω \pm 5% resistor (0402)
R65	1	332 Ω \pm 5% resistor (0402)
R63, R64, R67, R68	4	100 Ω \pm 5% resistor (0402)
R51-R53	—	Not installed
R55	1	20k Ω variable resistors Bourns 3296W
R57	1	50k Ω variable resistors Bourns 3296W
U4	1	MAX3737EGJ (32 QFN)
VCC, GND, TP11, TP13, TP19-TP21, TP24-TP28	12	Test points
None	1	Shunt
None	1	MAX3737 EV board
None	1	MAX3737 data sheet

*These components are part of the compensation network, which can reduce overshoot and ringing. Ringing due to parasitic series inductance of the laser may be eliminated with R39 and C24. Starting values for most coaxial lasers is R39 = 49.9 Ω in series with C24 = 8.2pF. These values should be experimentally adjusted until the output waveform is optimised.

Component Suppliers

SUPPLIER	PHONE	FAX
AVX	803-946-0690	803-626-3123
Coilcraft	847-639-6400	847-639-1469
Murata	814-237-1431	814-238-0490
Zetex	516-543-7100	516-864-7630

Note: Please indicate that you are using the MAX3737 when contacting these component suppliers.

Quick Start

Electrical Evaluation

In the electrical configuration, an automatic power control (APC) test circuit is included to emulate a semiconductor laser with a monitor photodiode. Monitor diode current is provided by transistor Q2, which is controlled by an operational amplifier (U2). The APC test circuit consisting of U2 and Q2 applies the simulated monitor diode current (the DC laser current divided by a factor of 80) to the MD pin of the MAX3737.

- 1) Place shunts on JU1-JU6, JU8-JU10, JU12 and JU13 (Refer to Table 1 for details).
- 2) If the EV kit is to be used without the optional shutdown transistor (Q3), place a shunt on JU11.
- 3) Remove the shunt from JU15 to use the filter inductor.
- 4) Connect TX_DISABLE to GND with JU1 to enable the outputs.
- 5) Standard electrical tests have bias and modulation current separated. Check that R11 (between TP6 and TP7) is installed. JU6 should be installed and JU7 left open. Also R15 should be open.

Note: When performing the following resistance checks, manually set the ohmmeter to a high range to avoid forward biasing the on-chip ESD protection diodes.

If the effect of bias current on current compliance must be tested then L1, R15, R16 and R17 should be installed. In this case move the jumper at JU6 to the JU7 position. The resistor R11 should be removed in this case.

- 6) Adjust R27, the R_{MODSET} potentiometer, for 25kΩ resistance between TP10 and ground.
- 7) Adjust R26, the R_{APCSET} potentiometer, for 25kΩ resistance between TP9 and ground.
- 8) Adjust R3, the R_{PC_MON} potentiometer, to set the maximum monitor diode current (I_{MDMAX}, see below). R_{PC_MON} can be measured from TP1 to ground. Connect the R_{PC_MON} using JU2.

$$R_{PC_MON} = \frac{V_{REF}}{I_{MDMAX}}$$

- 9) Adjust R4, the R_{BC_MON} potentiometer, to set the maximum bias current (I_{BIASMAX}, see below). R_{BC_MON} can be measured from TP2 to ground. Connect the R_{BC_MON} using JU3.

$$R_{BC_MON} = \frac{80 \times V_{REF}}{I_{BIASMAX}}$$

- 10) Adjust R7, the R_{MC_MON} potentiometer, to set the maximum modulation current (I_{MODMAX}, see below). R_{MC_MON} can be measured from TP3 to ground. Connect the R_{MC_MON} using JU4.

$$R_{MC_MON} = \frac{268 \times V_{REF}}{I_{MODMAX}}$$

- 11) Apply a differential input signal (200mV_{P-P} to 2400mV_{P-P}) between SMA connectors J1 and J2 (IN+ and IN-).
- 12) Attach a high-speed oscilloscope with a 50Ω input to the SMP connector J7 (OUT+).
Note: J7 has a DC voltage of approximately V_{CC}/2 and can have voltage swings greater than 1V. An attenuator might be needed to make the signal compatible with the oscilloscope.
- 13) Connect a +3.3V supply between V_{CC} and GND. Adjust the power supply until the voltage between TP12 and ground is +3.3V.
- 14) Adjust R25 (R_{APCSET}) until the desired laser bias current is achieved.

$$I_{BIAS} = \frac{V_{TP7} - V_{TP6}}{4.9\Omega}$$

- 15) The MD and BIAS currents can be monitored at TP1 (V_{PC_MON}), TP2 (V_{BC_MON}) and TP3 (V_{MC_MON}) using the equation below:

$$I_{MD} = \frac{V_{PC_MON}}{R_{PC_MON}}$$

$$I_{BIAS} = \frac{80 \times V_{BC_MON}}{R_{BC_MON}}$$

$$I_{MOD} = \frac{268 \times V_{MC_MON}}{R_{MC_MON}}$$

- 16) Adjust R27 until the desired laser modulation current is achieved. Measure I_{MOD} with the oscilloscope at J7 by;

$$I_{MOD} = \frac{\text{Signal Amplitude (V}_{P-P})}{15\Omega}$$

MAX3737 Evaluation Kit

Optical Evaluation

For optical evaluation of the MAX3737, configure the evaluation kit as follows:

- 1) Remove shunt JU16 to use the filter inductor.
- 2) If the EV kit is to be used without the optional shutdown transistor (Q4), place a shunt on JU20.
- 3) To enable the outputs, connect TX_DISABLE to GND by placing a shunt on JU30.
- 4) The EV kit is designed to allow connection of a variety of possible laser/monitor diode pin configurations. Connect a TO-header style laser with monitor diode (Figure 1) as follows:
 - Keeping its leads as short as possible, connect the laser diode to two of the three pads in the cutout portion on the top (component) side of the PC board. Solder the laser diode cathode to the center pad, and solder the anode to either of the other two pads (they are both connected to V_{CC} through the shutdown transistor (Q4)).
 - Connect the monitor photodiode to two of the five pads on the bottom (solder) side of the PC board, directly below the laser diode pads. Connect the anode and cathode of the photodiode as shown in figure 1.

Note: When performing the following resistance checks, manually set the ohmmeter to a high range to avoid forward biasing the on-chip ESD protection diodes.

- 1) Adjust R57, the R_{MODSET} potentiometer, for maximum resistance (≈50kΩ) between TP19 and ground. This sets the modulation current to a low value (<10mA). (Refer to the *Design Procedure* section of the MAX3737 data sheet.)
- 6) Adjust R55, the R_{APCSET} potentiometer, for maximum resistance (≈50kΩ) between TP20 and ground. This sets the photodiode current to a low value (<18μA). (Refer to the *Design Procedure* section of the MAX3737 data sheet.)

WARNING: Consult your laser data sheet to ensure that 18μA of photodiode current and 10mA of modulation current does not correspond to excessive laser power.

- 7) Install R67, the R_{PC_MON} resistor, to set the maximum monitor diode current (I_{MDMAX}, see below).

$$R_{PC_MON} = \frac{V_{REF}}{I_{MDMAX}}$$

- 8) Install R64, the R_{BC_MON} resistor, to set the maximum bias current (I_{BIASMAX}, see below).

$$R_{BC_MON} = \frac{80 \times V_{REF}}{I_{BIASMAX}}$$

- 9) Install R63, the R_{MC_MON} resistor, to set the maximum modulation current (I_{MODMAX}, see below).

$$R_{MC_MON} = \frac{268 \times V_{REF}}{I_{MODMAX}}$$

- 10) Apply a differential input signal (200mV_{P-P} to 2400mV_{P-P}) between SMA connectors J5 and J4 (IN+ and IN-).
- 11) Attach the laser diode fiber connector to an optical/electrical converter.
- 12) Connect a +3.3V supply between J3 (V_{CC}) and J6 (GND). Adjust the power supply until the voltage between TP15 and ground is +3.3V.
- 13) Adjust R55 (R_{APCSET}) until the desired average optical power is achieved.
- 14) The MD, MOD and BIAS currents can be monitored at TP28 (V_{PC_MON}) and TP27 (V_{BC_MON}) and TP26 (V_{MC_MON}) using the equations below:

$$I_{MD} = \frac{V_{PC_MON}}{R_{PC_MON}}$$

$$I_{BIAS} = \frac{80 \times V_{BC_MON}}{R_{BC_MON}}$$

$$I_{MOD} = \frac{268 \times V_{MC_MON}}{R_{MC_MON}}$$

Note: If the voltage at TP26, TP27 or TP28 exceeds 1.38V, the TX_FAULT signal will be asserted and latched.

- 15) Adjust R57 (R_{MODSET}) until the desired optical amplitude is achieved. Optical amplitude can be observed on an oscilloscope connected to an optical/electrical converter. Laser overshoot and ringing can be improved by appropriate selection of R39 and C24, as described in the *Design Procedure* section of the MAX3737 data sheet.

MAX3737 Evaluation Kit

Table 1. Adjustment and Control Descriptions (see Quick Start first)

COMPONENT		NAME	FUNCTION
OPTICAL	ELECTRICAL		
D4	D1	Fault Indicator	LED is illuminated when a fault condition has occurred (Refer to the <i>Detailed Description</i> section of the MAX3735 data sheet).
JU16	JU15	—	Placing a shunt on JU1 or JU20 removes the inductor from the filter networks by shorting the inductor lead together. Remove shunts for normal operation.
	JU5	—	Connects the open collector FAULT output to the LED indicator. The LED is illuminated when FAULT is asserted.
—	JU13	—	Placing a shunt on JU6 connects the MODSET pin of the MAX3737 to the R _{MODSET} potentiometer. Select a fixed resistor value when testing over temperature.
—	JU8	—	Placing a shunt on JU8 connects the emulated monitor diode current to the MD pin of the MAX3737.
JU30	JU1	TX_DISABLE	Enables/disables the output currents. Active low (shunt across JU1 or JU30 to enable output currents).
—	JU12	—	Placing a shunt on JU10 connects the APCSET pin of the MAX3737 to the R _{APCSET} potentiometer. Select a fixed resistor value when testing over temperature.
JU20	JU11	—	Installing a jumper on JU11 or JU20 disables the optional shutdown transistors.
R57	R27	R _{MODSET}	Adjusts the laser modulation current
R55	R26	R _{APCSET}	Adjusts the monitor diode current level to be maintained by the APC loop
R51	R31, JU14	R _{MODBCOMP}	Sets the k factor compensation of the modulation current. Leave open to make modulation current independent of bias current.
R52	R32	R _{TH_TEMP}	Sets the threshold temperature above which modulation current increases with temperature.
R53	R33	R _{MODTCOMP}	Sets the temperature coefficient of the modulation current. Leave open to make modulation current independent of temperature.

Evaluates: MAX3737

MAX3737 Evaluation Kit

Evaluates: MAX3737

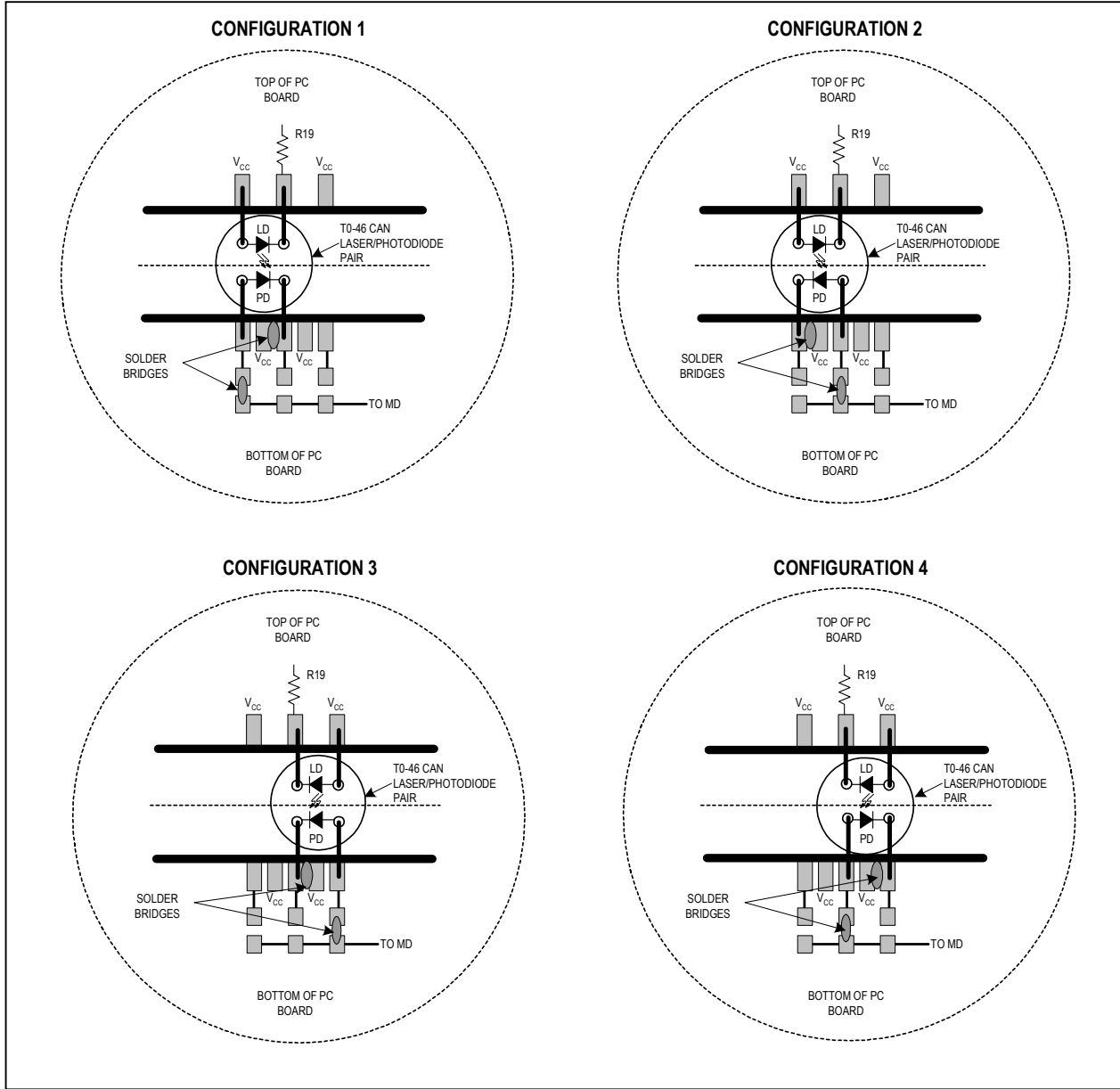

Figure 1. Attachment of Laser Diode/Monitor Diode to the MAX3737 EV Kit

MAX3737 Evaluation Kit

Evaluates: MAX3737

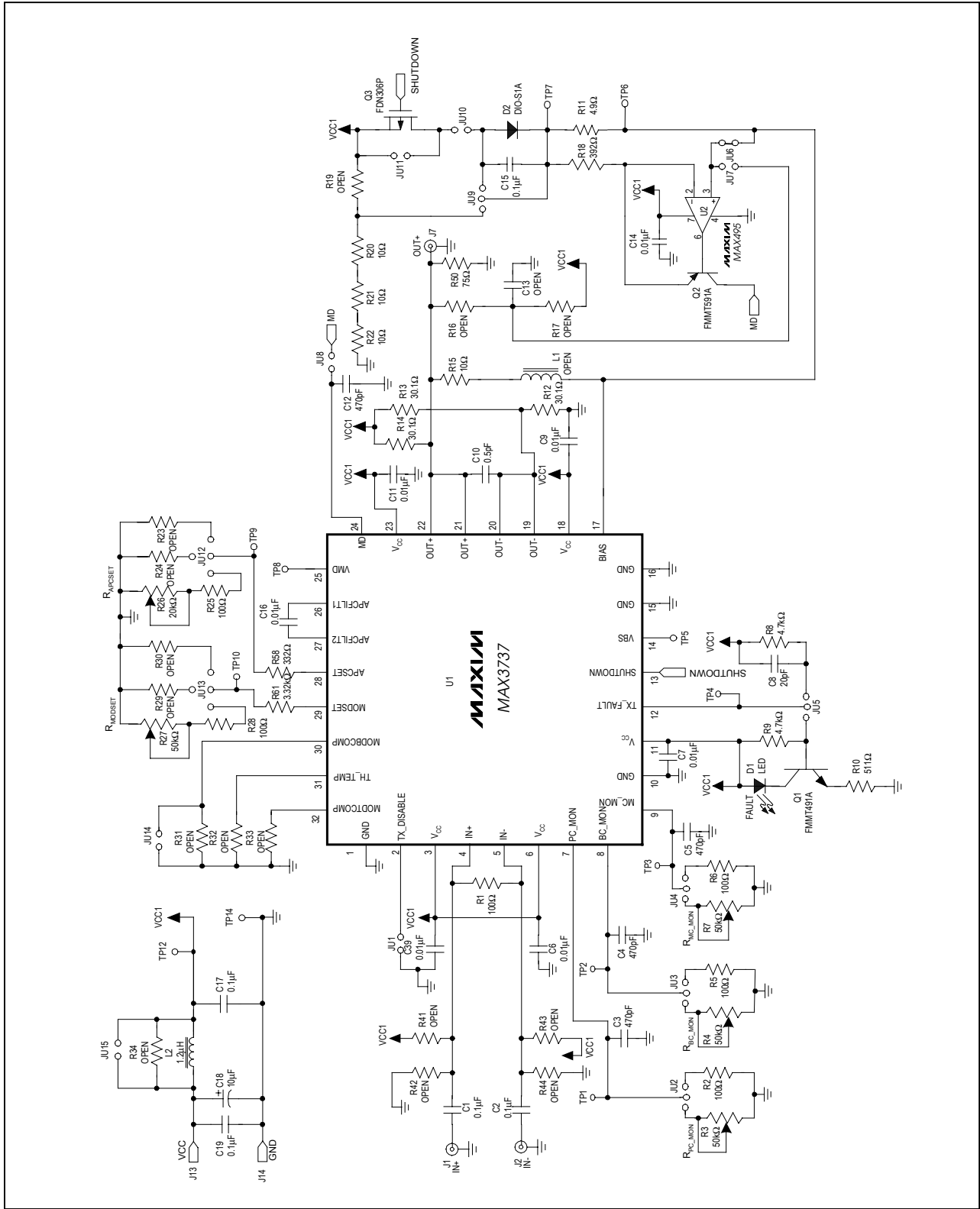

Figure 2. MAX3737 EV Kit Schematic—Electrical Configuration

MAX3737 Evaluation Kit

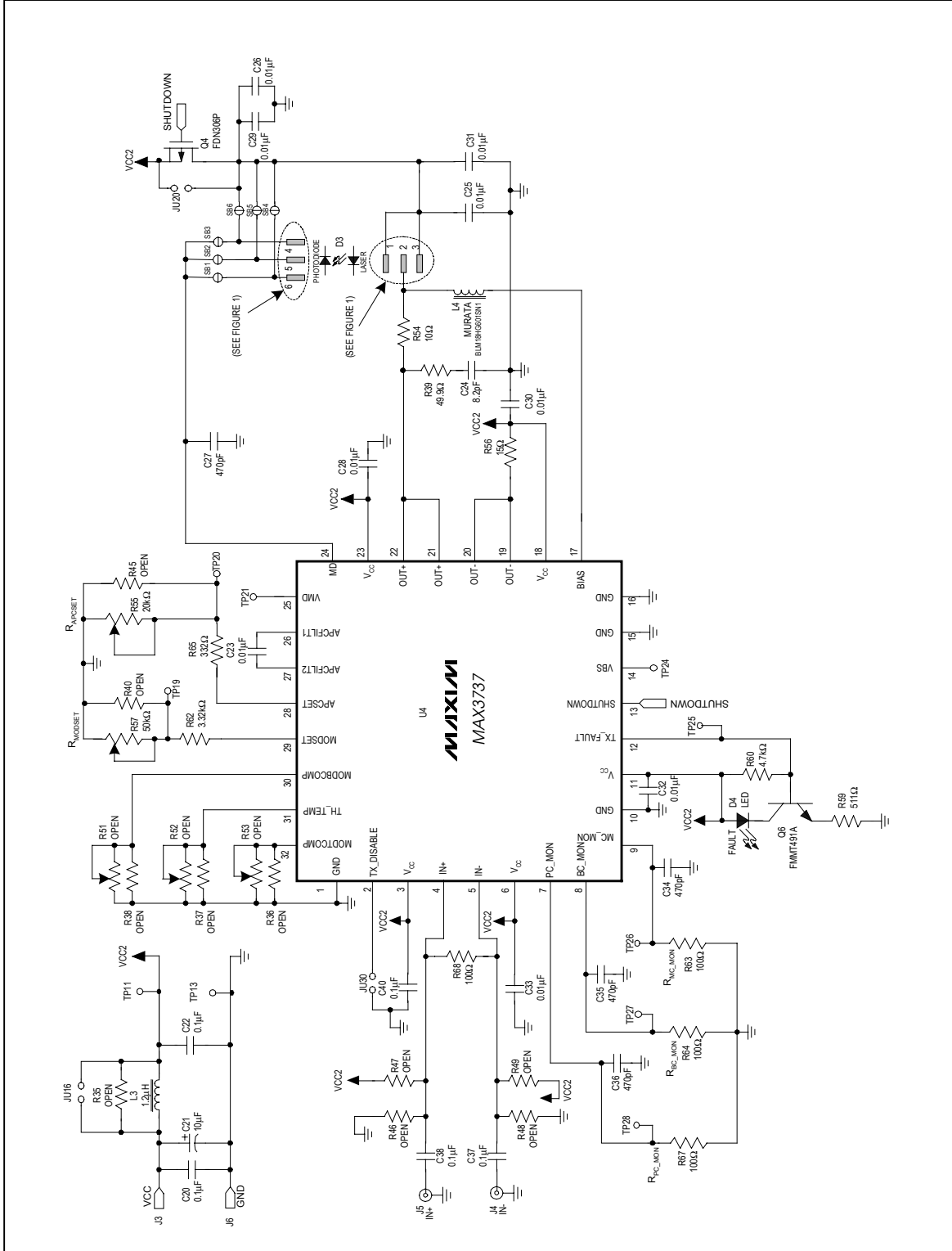

Figure 3. MAX3737 EV Kit Schematic—Optical Configuration

MAX3737 Evaluation Kit

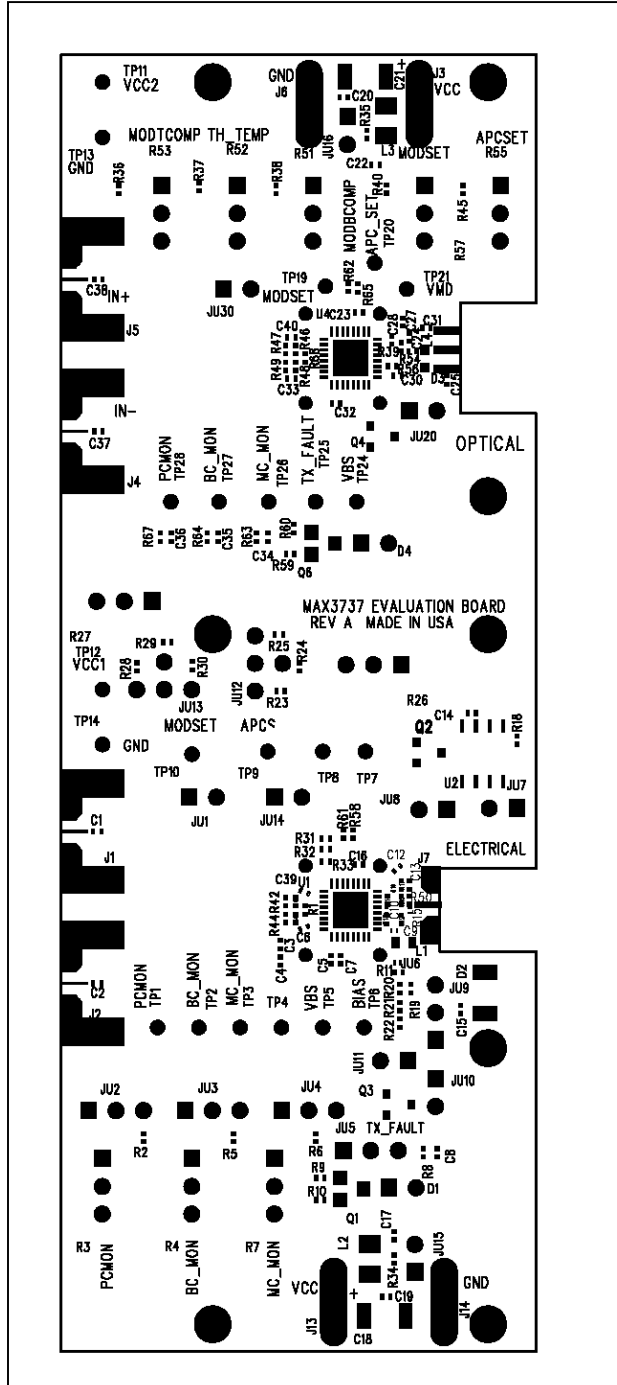

Figure 4. MAX3737 EV Kit PC Component Placement Guide—Component Side

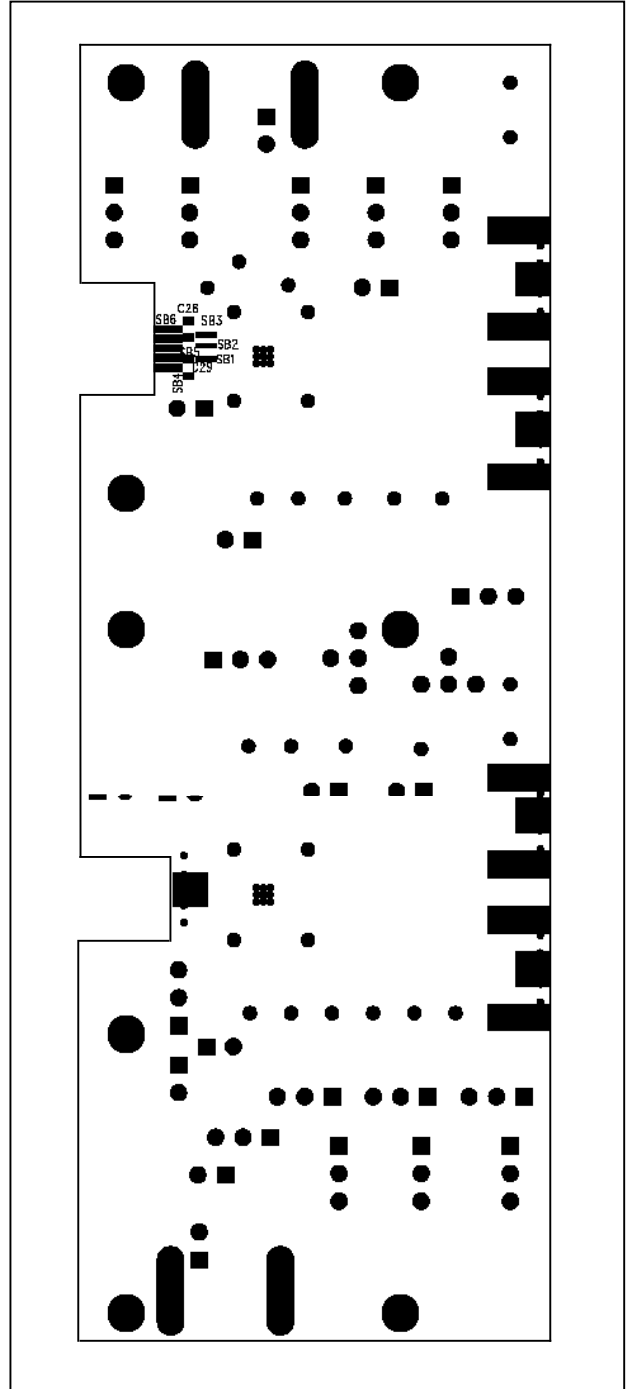

Figure 5. MAX3737 EV Kit PC Component Placement Guide—Solder Side

Evaluates: MAX3737

MAX3737 Evaluation Kit

Evaluates: MAX3737

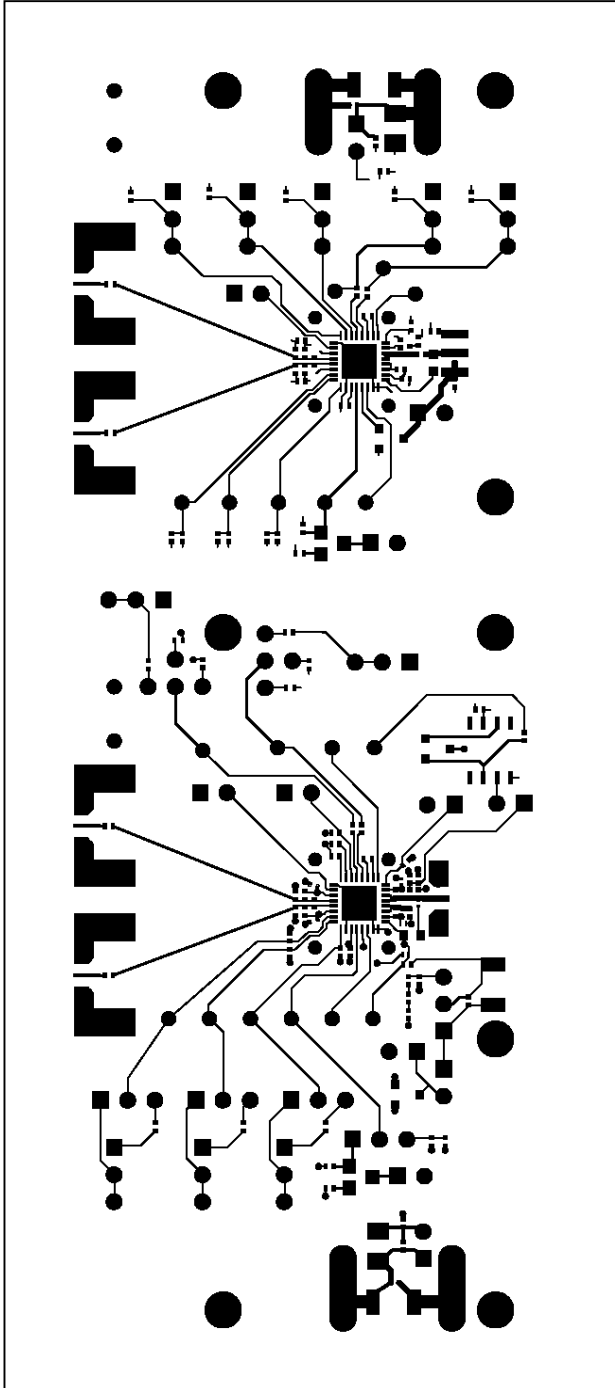

Figure 6. MAX3737 EV Kit PC Board Layout—Component Side

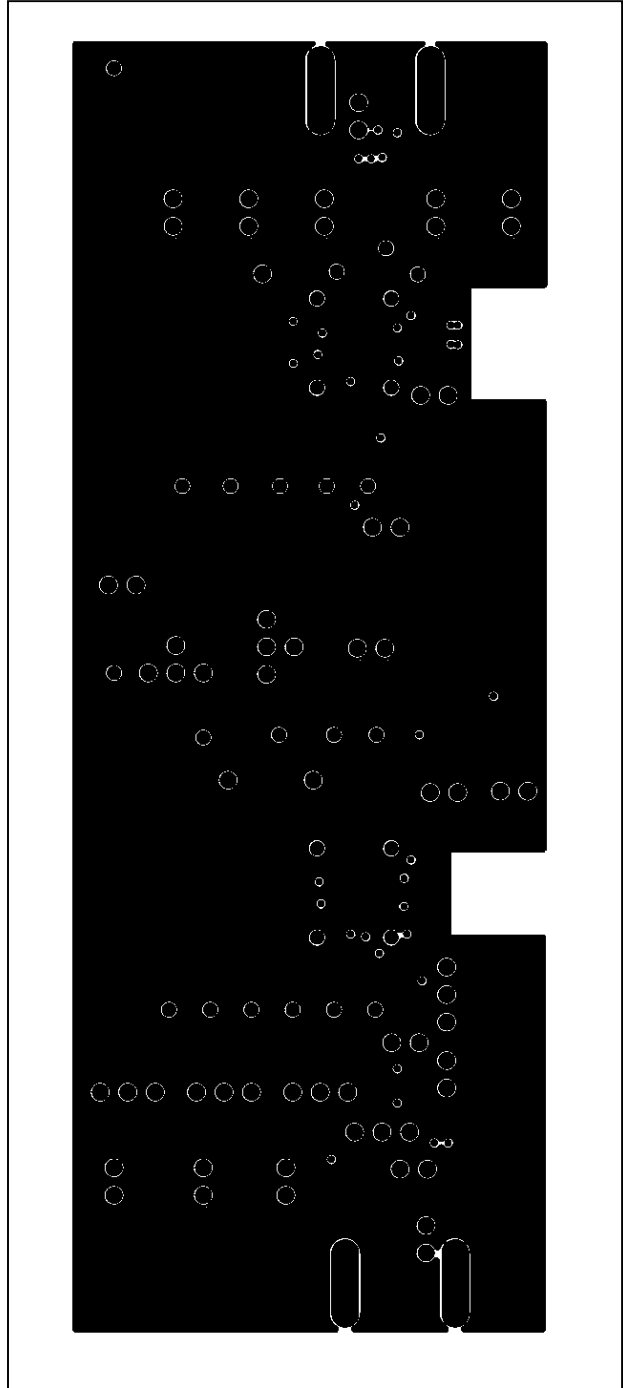

Figure 7. MAX3737 EV Kit PC Board Layout—Ground Plane

MAX3737 Evaluation Kit

Evaluates: MAX3737

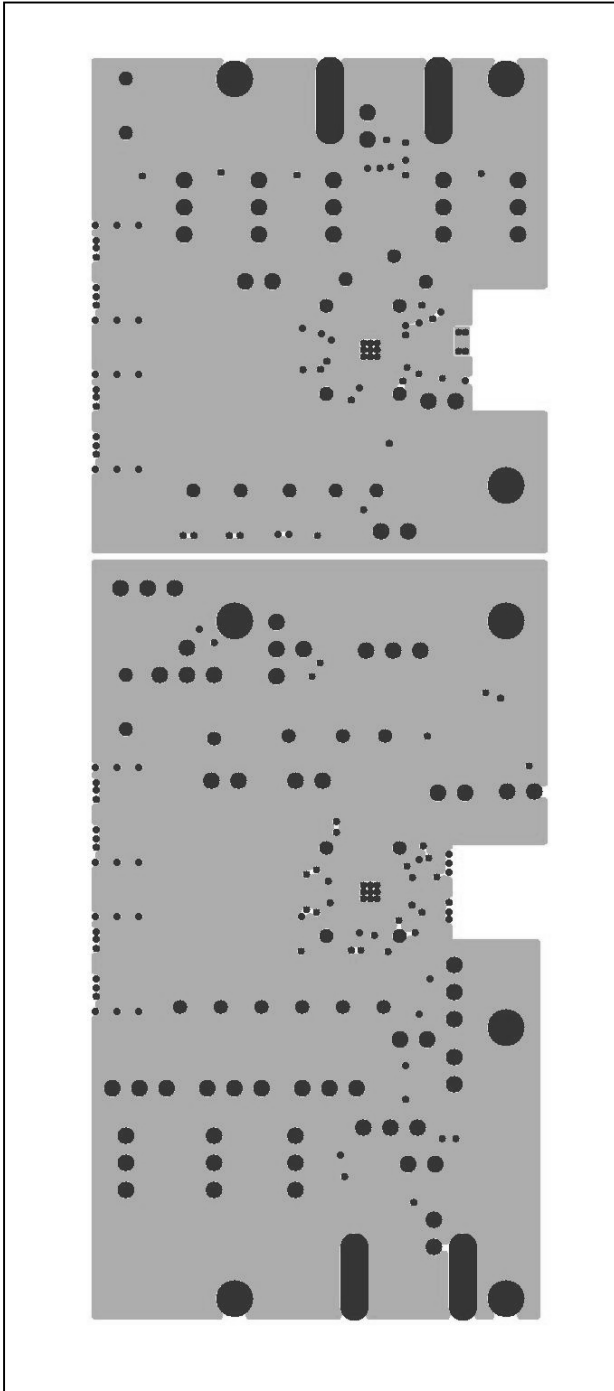

Figure 8. MAX3737 EV Kit PC Board Layout—Power Plane

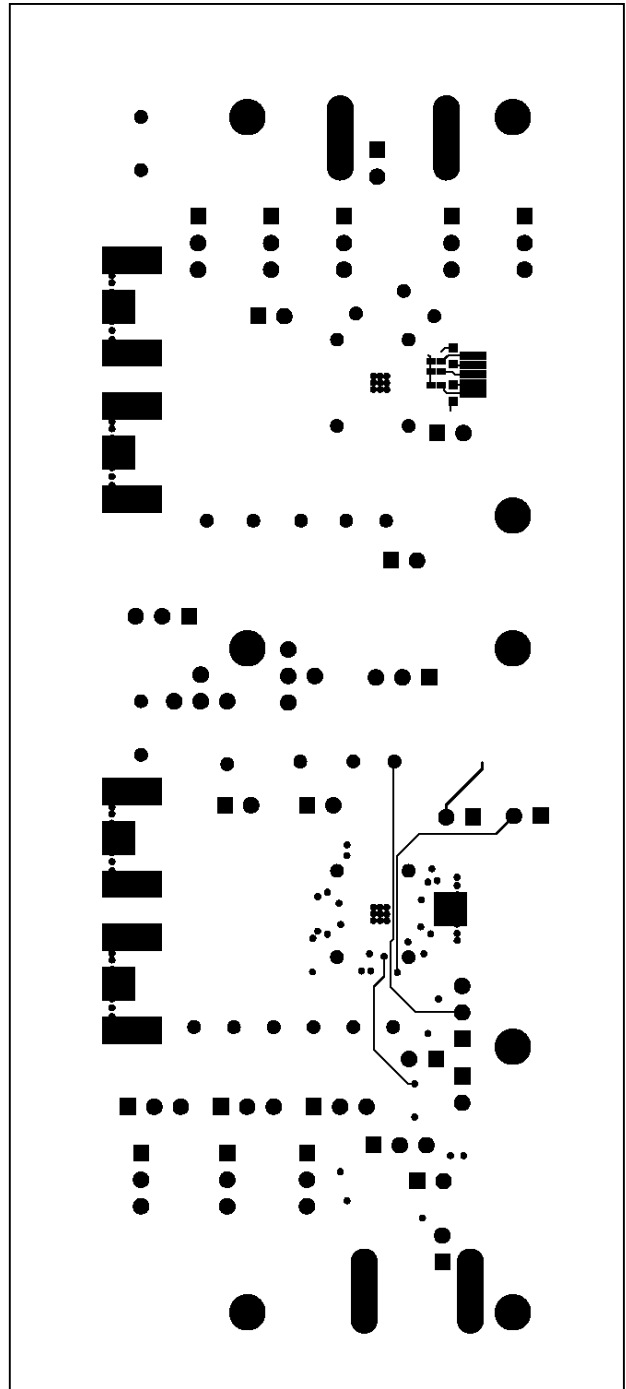

Figure 9. MAX3737 EV Kit PC Board Layout—Solder Side

Maxim cannot assume responsibility for use of any circuitry other than circuitry entirely embodied in a Maxim product. No circuit patent licenses are implied. Maxim reserves the right to change the circuitry and specifications without notice at any time.

Maxim Integrated Products, 120 San Gabriel Drive, Sunnyvale, CA 94086 408-737-7600

11