

F4-56

Description:

The F4-56 Quick Pack small power transformer offers a significant reduction in size and weight over a standard transformer. This transformer can be used for a wide variety of applications. It is bobbin wound for reduced size and small operating space.

Electrical Specifications (@25C);

Maximum Power: 6.0VA

Input Voltage: 115VAC@50/60Hz

Output Voltage: 56VCT@0.11A¹

Recommended Fuse: UL listed 250VAC, 0.15A, Slo-Blo

Hipot: 2500VAC primary to secondary; 1500VAC windings to core.

Construction:

Split bobbin non concentric winding eliminates costly electrostatic shielding. Termination is suitable for quick connects or soldering. Built with UL Class B Insulation System.

Safety:

UL: File E53148, UL 5085-1 and 2 (formerly UL 506), General Purpose.

UL: File E65390, UL5085-1 and 3, Class 3



Dimensions:

A	B	C	D	E	F	G
1.375	2.0±.03	2.375	1.250	1.687	.187 Dia	.687

- Notes:**
1. Units: inches.
 2. Terminal size: .187" X 0.021".
 3. Weight: .44 lbs

Schematic:

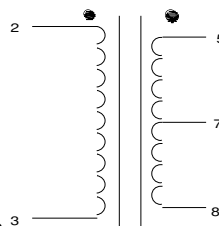

Input: Input 2 & 3

Output: 5 to 8

RoHS Compliance: As of manufacturing date February 2016, all standard products meet the requirements of 2015/863/EU, known as the RoHS 3 initiative.

* Upon printing, this document is considered "uncontrolled". Please contact Triad Magnetics' website for the most current version.

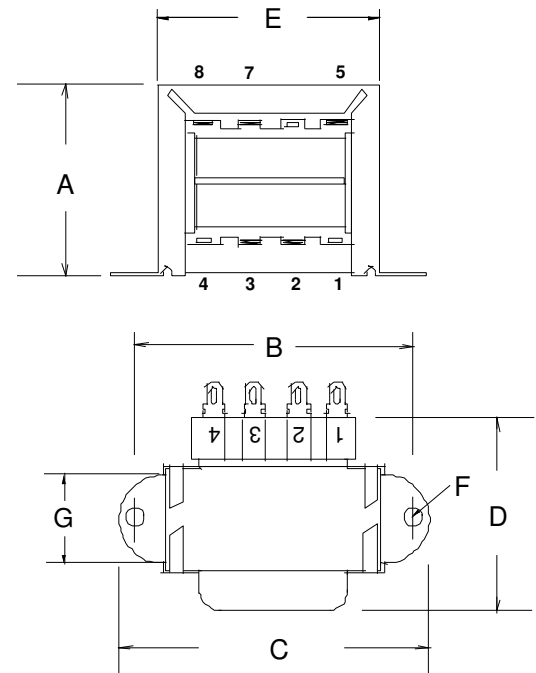
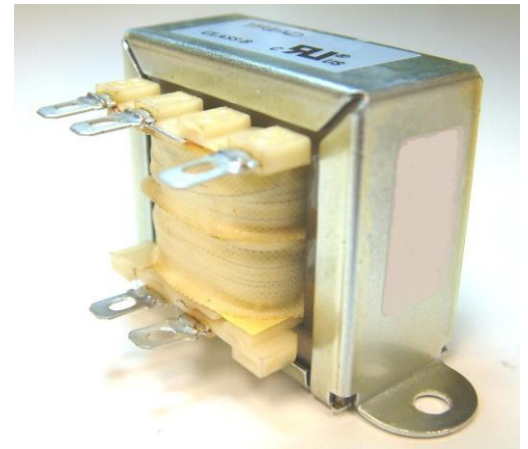

¹ Fuse must be used on **secondary** as conditions of acceptability for UL Class 2/3 operation.