



# 1559-1606 MHz GNSS BAND ANTENNA

Standard Antenna Solutions

Part Number: 2195762-1

## PRODUCT FACTS:

- Embedded ceramic patch antenna
- Through-hole assembly
- RoHS compliant

## RECOMMENDATIONS:

- Minimum or no matching circuits required
- Bandwidth and performance is dependent on ground plane size 70mm x 70mm
- PCB ground is to be on top layer

## SPECIFICATIONS:

- Frequency Range: 1559-1606 MHz
- Gain at Zenith:
  - 1575.4 MHz: 4.1 dBi typ
  - 1602 MHz: 5.7 dBi typ
- Axial ratio:
  - 1575.4 MHz: 5 dB typ.
  - 1602 MHz: 2 dB typ.
- Feed Point Impedance: 50 ohms
- VSWR: <3.0: 1
- Polarization: R.H.C.P
- Size: 35.5mm x 35.5mm x 4.1mm
- Pin Length: 1.5 mm
- Weight: 16 g
- Mounting Guide: See diagram on page 2
- Operating Temperature: -40° to 105°C

## TEST ORIENTATION IN FREE SPACE:

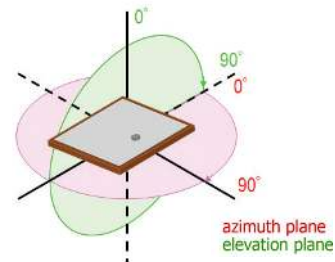

## VSWR:

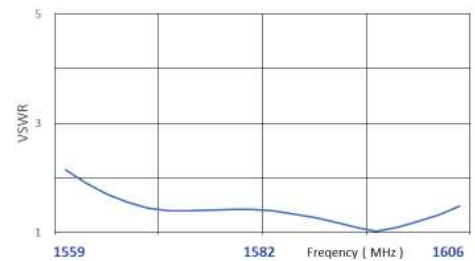

## AZIMUTH:

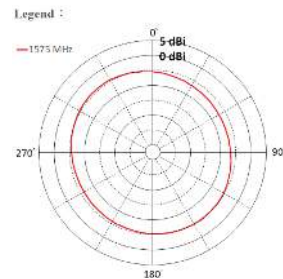

## ELEVATION:

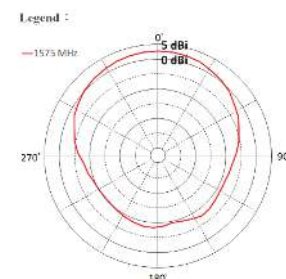

## EFFICIENCY:

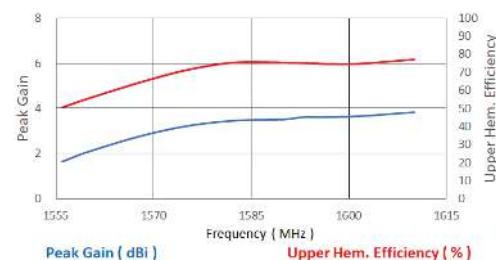

# 1559-1606 MHz GNSS Band Antenna

Standard Antenna Solutions

## MOUNTING GUIDE:

Top Side

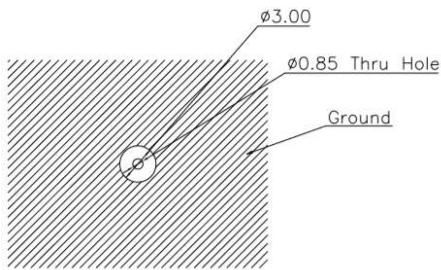

Bottom Side

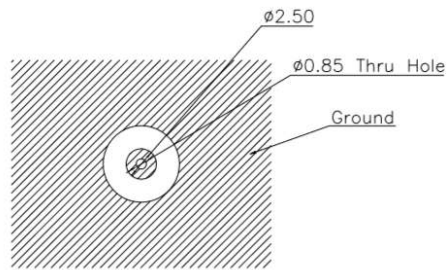

Tolerance:  $\pm 0.2$   
Unit: mm

## KEEP OUT AREA:

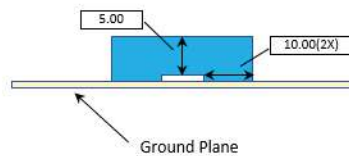
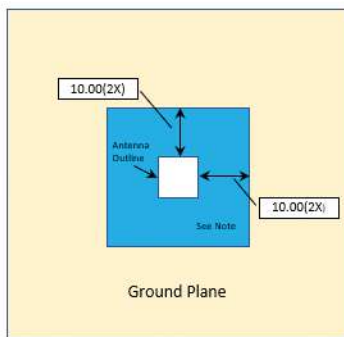

- NOTES : 1. Antenna designed to be mounted on ground plane.  
2. Area in blue above indicates Keep Out Area.  
3. For more information please call TE.

Dimensions : mm  
Diagram is not to scale

## APPROXIMATE DIMENSIONS:

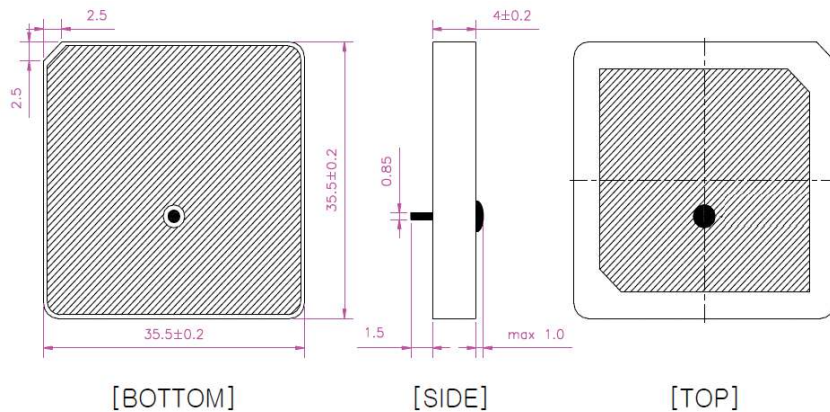

# 1559-1606 MHz GNSS Band Antenna

Standard Antenna Solutions

---

## TE TECHNICAL SUPPORT CENTER

USA:	+1 (800) 522-6752
Canada:	+1 (905) 475-6222
Mexico:	+52 (0) 55-1106-0800
Latin/S. America	+54 (0) 11-4733-2200
Germany:	+49 (0) 6251-133-1999
UK:	+44 (0) 800-267666
France:	+33 (0) 1-3420-8686
Netherlands:	+31 (0) 73-6246-999
China:	+86 (0) 400-820-6015

For phone numbers in other countries, go to [te.com/support-center](http://te.com/support-center)

## te.com

TE Connectivity, TE Connectivity (logo) and Every Connection Counts are trademarks. All other logos, products and/or company names referred to herein might be trademarks of their respective owners.

The information given herein, including drawings, illustrations and schematics which are intended for illustration purposes only, is believed to be reliable. However, TE Connectivity makes no warranties as to its accuracy or completeness and disclaims any liability in connection with its use. TE Connectivity's obligations shall only be as set forth in TE Connectivity's Standard Terms and Conditions of Sale for this product and in no case will TE Connectivity be liable for any incidental, indirect or consequential damages arising out of the sale, resale, use or misuse of the product. Users of TE Connectivity products should make their own evaluation to determine the suitability of each such product for the specific application.

© 2019 TE Connectivity Ltd. family of companies All Rights Reserved.

1-1773969-8 01/19 Original