

AS9013-L-HF/H-HF/J-HF (NPN)

RoHS Device

Halogen Free

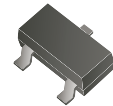

Features

- Epoxy meets UL-94 V-0 flammability rating.
- Moisture sensitivity Level 1.
- AEC-Q101 Qualified.

Mechanical data

- Case: SOT-23, molded plastic.
- Terminals: Tin plated leads, solderable per J-STD-002 and JESD22-B102.

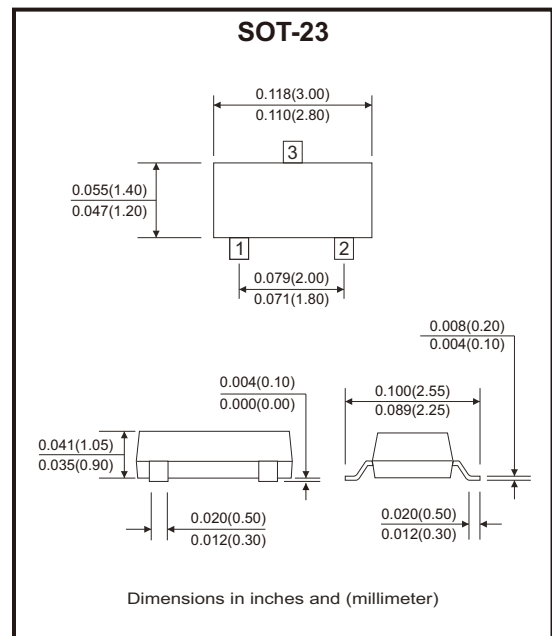

Circuit Diagram

1. Base
2. Emitter
3. Collector

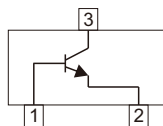

Maximum Ratings (at $T_A=25^{\circ}\text{C}$ unless otherwise noted)

Parameter	Symbol	Value	Unit
Collector-base voltage	V_{CBO}	40	V
Collector-emitter voltage	V_{CEO}	25	V
Emitter-base voltage	V_{EBO}	5	V
Collector current-continuous	I_C	500	mA
Total device dissipation	P_D	300	mW
Maximum junction temperature	T_J	150	$^{\circ}\text{C}$
Storage temperature range	T_{STG}	-55 to +150	$^{\circ}\text{C}$

Electrical Characteristics (at $T_A=25^\circ\text{C}$ unless otherwise noted)

Parameter	Symbol	Conditions	Min	Max	Unit
Collector-base breakdown voltage	$V_{(BR)CBO}$	$I_C = 100\mu\text{A}, I_E = 0$	40		V
Collector-emitter breakdown voltage	$V_{(BR)CEO}$	$I_C = 1\text{mA}, I_B = 0$	25		V
Emitter-base breakdown voltage	$V_{(BR)EBO}$	$I_E = 100\mu\text{A}, I_C = 0$	5		V
Collector cut-off current	I_{CBO}	$V_{CB} = 40\text{V}, I_E = 0$		100	nA
Collector cut-off current	I_{CEO}	$V_{CE} = 20\text{V}, I_B = 0$		100	nA
Emitter cut-off current	I_{EBO}	$V_{EB} = 5\text{V}, I_C = 0$		100	nA
DC current gain	$h_{FE(1)}$	$V_{CE} = 1\text{V}, I_C = 50\text{mA}$	120	400	
	$h_{FE(2)}$	$V_{CE} = 1\text{V}, I_C = 500\text{mA}$	40		
Collector-emitter saturation voltage	$V_{CE(sat)}$	$I_C = 500\text{mA}, I_B = 50\text{mA}$		0.6	V
Base-emitter saturation voltage	$V_{BE(sat)}$	$I_C = 500\text{mA}, I_B = 50\text{mA}$		1.2	V
Small-signal characteristics					
Transition frequency	f_T	$V_{CE} = 6\text{Vdc}, I_C = 20\text{mA}, f = 30\text{MHz}$	150		MHz

Classification of h_{FE} (1)

Rank	AS9013-L-HF	AS9013-H-HF	AS9013-J-HF
Range	120-200	200-350	300-400

Rating and Characteristic Curves (AS9013-L-HF/H-HF/J-HF)

Fig.1 - Static Characteristic

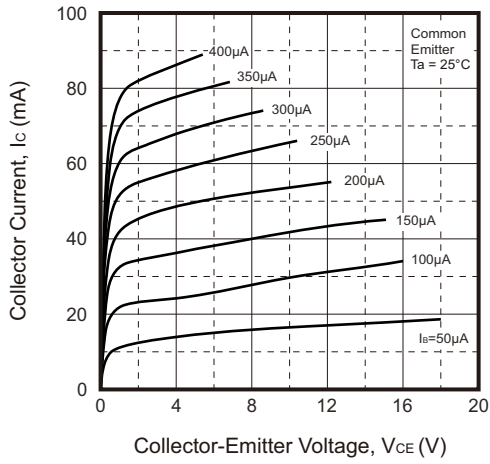

Fig.2 - $h_{FE} - I_c$

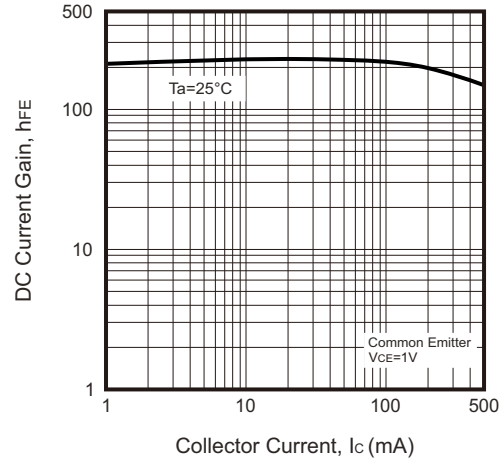

Fig.3 - Base-Emitter Saturation Voltage vs. Collector Current

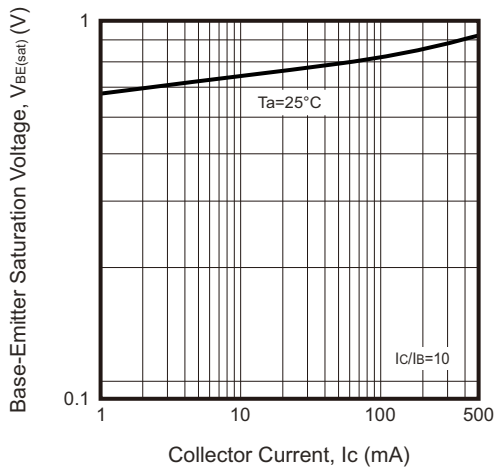
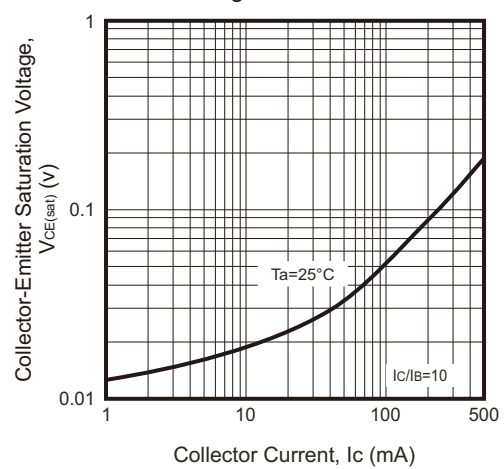
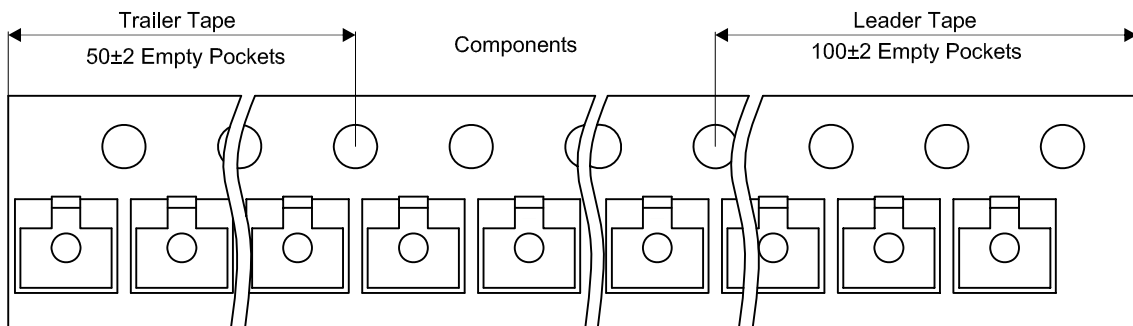
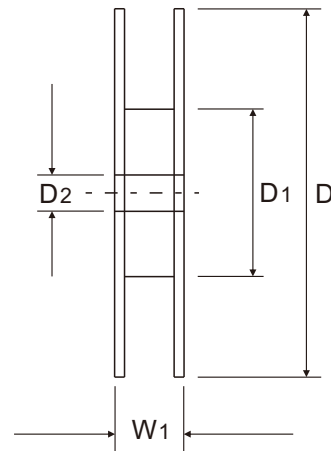
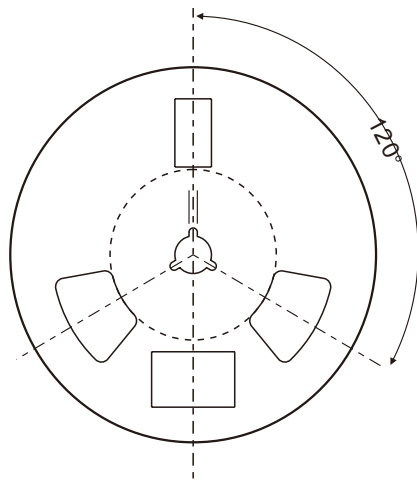
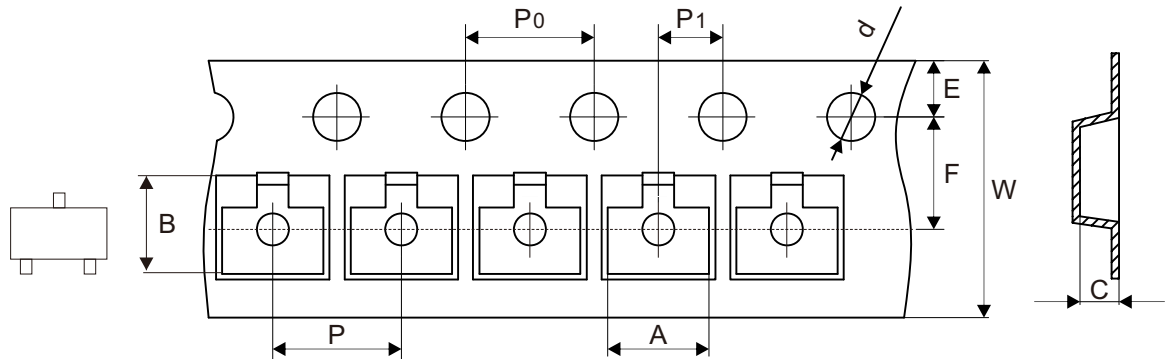

Fig.4 - Collector-Emitter Saturation Voltage vs. Collector Current



Reel Taping Specification



SOT-23	SYMBOL	A	B	C	d	D	D1	D2
	(mm)	3.15 ± 0.10	2.77 ± 0.10	1.22 ± 0.10	1.50 + 0.10 - 0.00	178.00 ± 1.00	54.60 ± 1.00	13.30 ± 1.00
	(inch)	0.124 ± 0.004	0.109 ± 0.004	0.048 ± 0.004	0.059 + 0.004 - 0.000	7.008 ± 0.039	2.150 ± 0.039	0.524 ± 0.039

SOT-23	SYMBOL	E	F	P	P0	P1	W	W1
	(mm)	1.75 ± 0.10	3.50 ± 0.05	4.00 ± 0.10	4.00 ± 0.10	2.00 ± 0.05	8.00 + 0.30 - 0.10	11.10 ± 0.20
	(inch)	0.069 ± 0.004	0.138 ± 0.002	0.157 ± 0.004	0.157 ± 0.004	0.079 ± 0.002	0.315 + 0.012 - 0.004	0.437 ± 0.008

Company reserves the right to improve product design, functions and reliability without notice. REV:A

Marking Code

Part Number	Marking Code
AS9013-L-HF	J3.
AS9013-H-HF	
AS9013-J-HF	

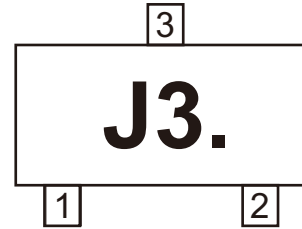

Suggested PAD Layout

SIZE	SOT-23	
	(mm)	(inch)
A	0.90	0.035
B	0.80	0.031
C	0.95	0.037
D	2.00	0.079
E	2.90	0.114

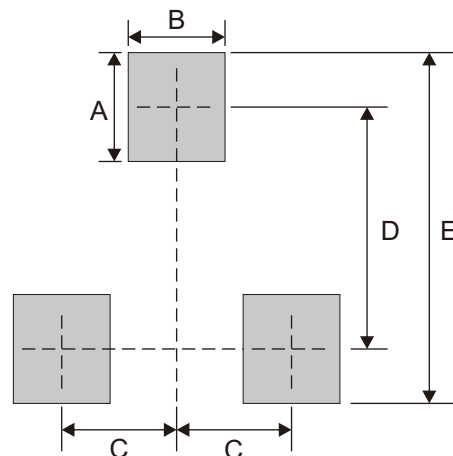

Note: 1. The pad layout is for reference purposes only.

Standard Packaging

Case Type	REEL PACK	
	REEL (pcs)	Reel Size (inch)
SOT-23	3,000	7