



GARDTEC

Part Number:

SC120-W6

Material: C1008 Steel
Finish: Bright Nickel Chrome Plating
Ring Diameter: 1.6mm
Rib Diameter: 2.0mm
General Tolerance Unless Noted: $\pm 0.5\text{mm}$
Unit: mm
RoHS/REACH Compliant

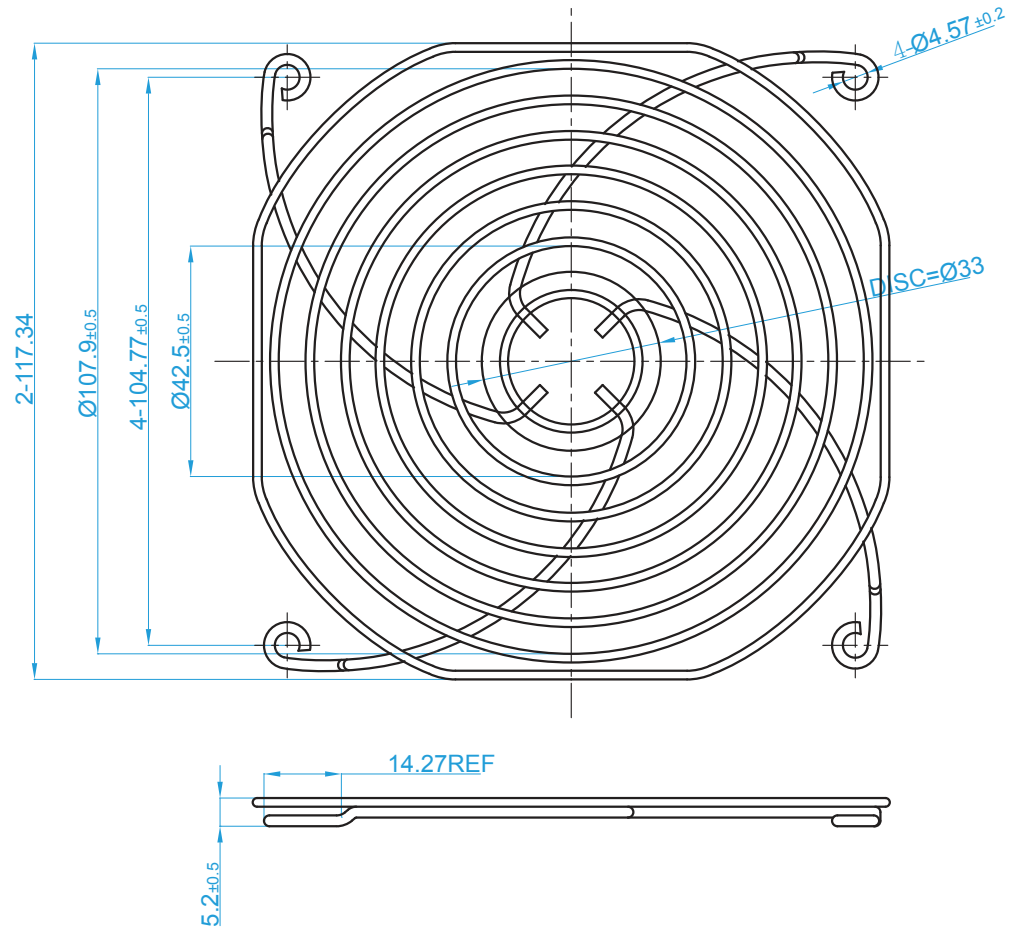

These drawings are the property of Gardtec, Inc and cannot be reproduced for or communicated to a third party without the express written permission of Gardtec, Inc.