

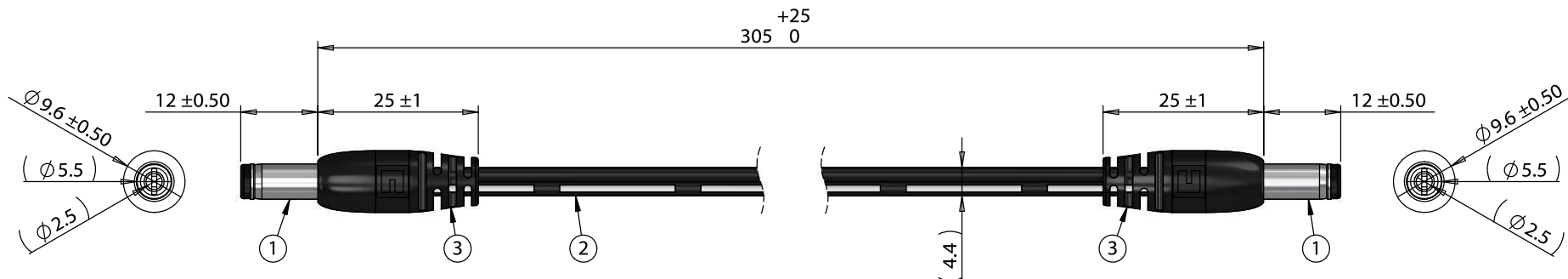

ITEM NO.	PART NUMBER	DESCRIPTION	QTY.	COMPONENT NOTES
1	50-00026	Connector, dc plug, 5.5x2.5xL23 mm, molding style, spring contacts	2	
2	30-00395	Wire, 2C TS, 18 AWG, UL2468, 300V, 80C, 4.4 mm, VW-1, PVC, 87A	1	
3	24-00003	Overmold, PVC	2	black



Notes:
Functionally equivalent components may be substituted

Wiring Diagram		
50-00026	wire color	50-00026
center	black with stripe	center
sleeve	black	sleeve

Revision:	Date:	Description:	Prepared:	Notes:	<h1>TENSILITY</h1> <p>tel 1.541.323.3228 800 877.670.7118 fax 1.541.323.4202 web tensility.com</p>	
A	01/19/2018	Initial release	GL <small>Digitally signed by GL Date: 2018.01.19 09:02:19 -08'00'</small>			RoHS compliant
			Verified:	Function test: no open, no short circuit, no intermittent	Size:	
			AW <small>Digitally signed by AW Date: 2018.02.14 08:58:55 -08'00'</small>	Description:	Part number:	
			Dimensions are in millimeters. Tolerances: X: ± 0.5 mm X.X: ± 0.3 mm X.XX: ± 0.05 mm	Cable, 305 mm, 5.5x2.5x12 mm 50-00026 dc plug to same, 18 AWG, UL2468, 30-00395 wire	A 10-02541	
					Scale: 1:1	
						Sheet 1 of 1

5

4

3

2

1