

PAGE 1/2	ISSUE 06-12-19A	SERIES COUPLER	PART NUMBER R433563000
----------	-----------------	-------------------	-------------------------------

Scale 1 : 1

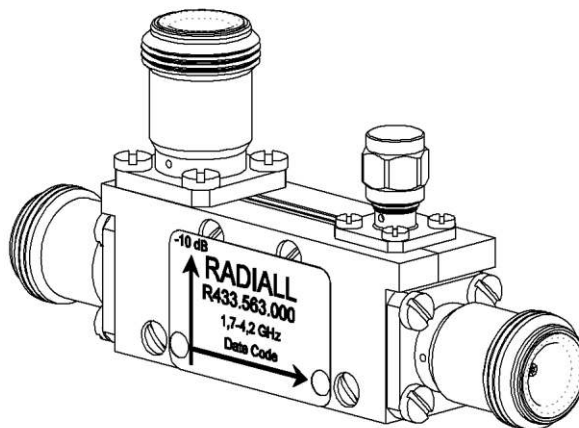

All dimensions are in mm. Tolerances according ISO 2768 m-H

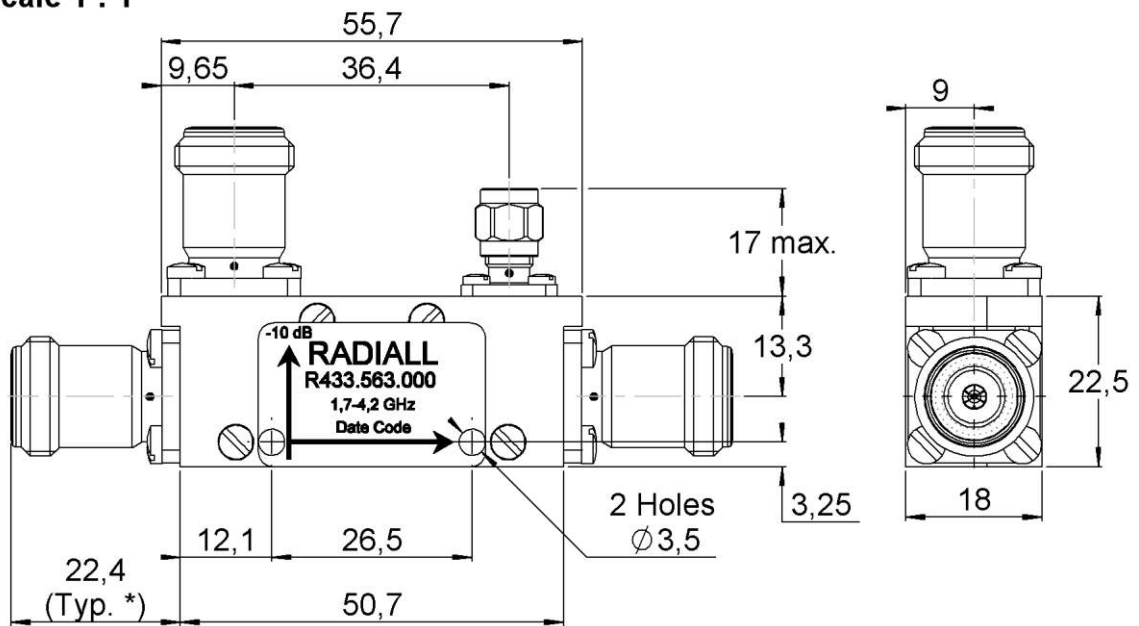

Weight Specification **137,1500** g

ELECTRICAL CHARACTERISTICS

Frequency operating range :	1.7 – 4.2 GHz
Impedance :	50 Ω
VSWR : - Main Line	1.25 max.
- Coupled Line	1.25 max.
Nominal Coupling :	10 dB
Coupling Precision :	± 0.5 dB
Insertion Loss :	1 dB max.
Directivity :	20 dB mini
Frequency Sensitivity :	± 0.3 dB
Average Power at 25°C	50W
Peak Power at 25°C	3000W

MECHANICAL CHARACTERISTICS

Connector type :	N female per MIL-C 39012
Coaxial Termination :	SMA, 50 Ω, 1W

ENVIRONMENTAL CHARACTERISTICS

Operating temperature :	-25°C / +85°C
Storage temperature :	-40°C / +100°C