

**User Manual**

## **PCE-3029/4129**

**LGA1151 Intel<sup>®</sup> Xeon, Core<sup>™</sup> i7/  
i5/i3/Celeron<sup>®</sup>/Pentium<sup>®</sup> PICMG  
1.3 Half-size System Host Board  
with VGA / DVI-D /DDR4 /  
SATA3.0 / USB3.0 / Dual GbE**

**ADVANTECH**

*Enabling an Intelligent Planet*

## Copyright

The documentation and the software included with this product are copyrighted 2016 by Advantech Co., Ltd. All rights are reserved. Advantech Co., Ltd. reserves the right to make improvements in the products described in this manual at any time without notice. No part of this manual may be reproduced, copied, translated or transmitted in any form or by any means without the prior written permission of Advantech Co., Ltd. Information provided in this manual is intended to be accurate and reliable. However, Advantech Co., Ltd. assumes no responsibility for its use, nor for any infringements of the rights of third parties, which may result from its use.

## Acknowledgements

AMIBIOS is a trademark of American Megatrends Inc.

Intel<sup>®</sup>, Core™i7/i5/i3, Pentium<sup>®</sup> and Xeon are trademarks of Intel<sup>®</sup> Corporation.

Nuvoton is a trademark of Nuvoton Technology Corp.

All other product names or trademarks are the properties of their respective owners.

## Product Warranty (2 years)

Advantech warrants to you, the original purchaser, that each of its products will be free from defects in materials and workmanship for two years from the date of purchase.

This warranty does not apply to any products which have been repaired or altered by persons other than repair personnel authorized by Advantech, or which have been subject to misuse, abuse, accident or improper installation. Advantech assumes no liability under the terms of this warranty as a consequence of such events.

Because of Advantech's high quality-control standards and rigorous testing, most of our customers never need to use our repair service. If an Advantech product is defective, it will be repaired or replaced at no charge during the warranty period. For out-of-warranty repairs, you will be billed according to the cost of replacement materials, service time and freight. Please consult your dealer for more details.

If you think you have a defective product, follow these steps:

1. Collect all the information about the problem encountered. (For example, CPU speed, Advantech products used, other hardware and software used, etc.) Note anything abnormal and list any onscreen messages you get when the problem occurs.
2. Call your dealer and describe the problem. Please have your manual, product, and any helpful information readily available.
3. If your product is diagnosed as defective, obtain an RMA (return merchandise authorization) number from your dealer. This allows us to process your return more quickly.
4. Carefully pack the defective product, a fully-completed Repair and Replacement Order Card and a photocopy proof of purchase date (such as your sales receipt) in a shippable container. A product returned without proof of the purchase date is not eligible for warranty service.
5. Write the RMA number visibly on the outside of the package and ship it prepaid to your dealer.

Part No. 2001302900

Printed in China

Edition 1

March 2016

# Declaration of Conformity

## FCC Class A

Note: This equipment has been tested and found to comply with the limits for a Class A digital device, pursuant to part 15 of the FCC Rules. These limits are designed to provide reasonable protection against harmful interference in a residential installation. This equipment generates, uses and can radiate radio frequency energy and, if not installed and used in accordance with the instructions, may cause harmful interference to radio communications. However, there is no guarantee that interference will not occur in a particular installation. If this equipment does cause harmful interference to radio or television reception, which can be determined by turning the equipment off and on, the user is encouraged to try to correct the interference by one or more of the following measures:

- Reorient or relocate the receiving antenna.
- Increase the separation between the equipment and receiver.
- Connect the equipment into an outlet on a circuit different from that to which the receiver is connected.
- Consult the dealer or an experienced radio/TV technician for help.

## A Message to the Customer

### Advantech Customer Services

Each and every Advantech product is built to the most exacting specifications to ensure reliable performance in the harsh and demanding conditions typical of industrial environments. Whether your new Advantech equipment is destined for the laboratory or the factory floor, you can be assured that your product will provide the reliability and ease of operation for which the name Advantech has come to be known.

Your satisfaction is our primary concern. Here is a guide to Advantech's customer services. To ensure you get the full benefit of our services, please follow the instructions below carefully.

### Technical Support

We want you to get the maximum performance from your products. So if you run into technical difficulties, we are here to help. For the most frequently asked questions, you can easily find answers in your product documentation. These answers are normally a lot more detailed than the ones we can give over the phone.

So please consult this manual first. If you still cannot find the answer, gather all the information or questions that apply to your problem, and with the product close at hand, call your dealer. Our dealers are well trained and ready to give you the support you need to get the most from your Advantech products. In fact, most problems reported are minor and are able to be easily solved over the phone.

In addition, free technical support is available from Advantech engineers every business day. We are always ready to give advice on application requirements or specific information on the installation and operation of any of our products.

## Memory Compatibility

Model	Advantech PN	Capacity	Data Rate	Type	ECC
PCE-3029/4129	AQD-SD4U16N21-SE	16GB	2133	DDR4	N
	AQD-SD4U16E21-SE	16GB	2133	DDR4	Y*
	AQD-SD4U8GN21-SG	8GB	2133	DDR4	N
	AD4S2133W8G15-BSSD	8GB	2133	DDR4	N
	AQD-SD4U4GN21-SG	4GB	2133	DDR4	N
	AD4S2133W4G15-BSSD	4GB	2133	DDR4	N

**Note!** \*PCE-3029 do not support ECC memory.





## Processor Support

Model	Advantech P/N	CPU Processor Socket LGA1151	Base Freq. (GHz)	L3 cache	Cores/ Treads	TDP (W)	DDR4 memory speed support	ECC	AMT
PCE-4129	96MPXES-3.6-8M11T	E3-1275 v5	3.6	8	4/8	80	1600/2133	Yes	11.0
	96MPXES-3.3-8M11T	E3-1225 v5	3.3	6	4/4	80	1600/2133	Yes	11.0
	-	E3-1268L v5	2.4	8	4/8	35	1600/2133	Yes	11.0
PCE-4129/3029	96MPI7S-3.4-8M11T	Core i7-6770	3.4	8	4/8	65	1600/2133	No	11.0
	96MPI7S-2.4-8M11T1	Core i7-6770TE	2.4	8	4/8	35	1600/2133	No	11.0
	96MPI5S-3.2-6M11T	Core i5-6500	3.2	6	4/4	65	1600/2133	No	11.0
	96MPI5S-2.3-6M11T1	Core i5-6500TE	2.3	6	4/4	35	1600/2133	Yes	11.0
	-	Core i3-6100	3.7	4	2/2	65	1600	Yes	-
	-	Core i3-6100TE	2.7	4	2/2	35	1600/2133	Yes	-
	96MPPS-3.3-3M11T	G4400	3.3	3	2/2	65	1600/2133	Yes	-
	-	G4400TE	2.9	3	2/2	35	1600/2133	Yes	-
	-	G3900	2.8	2	2/2	65	1600/2133	No	-
	-	G3900TE	2.6	2	2/2	35	1600/2133	No	-

## Backplane Support Matrix Table

Model processor	Backplane	
	PCE-3BXX	PCE-4BXX
PCE-3029G2-00A1E	Yes	-
PCE-4129G2-00A1E	Yes	Yes

**Note!**  If PCE-3029/4129 is used on different backplanes which has different PCIe configuration. Below message would be showed on first time power on, and user has to turn off AC power and then turn on for PCIe re-configuration.

**Caution!**  PCIe configuration error! Please turn off AC power before re-configuration.

## Specification Comparison

Part Number	PCH	Memory	VGA	Display port*	DVI-D**	Backplane	LAN	SATAIII	m-SATA	USB3.0	USB2.0	S/W RAID	i-AMT 9.0	mini-PCIe*
PCE-3029G2-00A1E	H110	Non-ECC	1	1	1	PCE-3BXX	2 GbE	3 (default) 4 (optional)	1 (default) 0 (when SATA III x4 is chosen)	3	7	N/A	N/A	1
PCE-4129G2-00A1E	C236	ECC	1	1	1	PCE-3BXX/ 4BXX	2 GbE	4	1	3	7	Yes	Yes	1

**Note!**  \* Optional PCE-SA01-00A1E is required. PCE-SA01-00A1E is compatible with IPC-3026/IPC-6806S/ACP-4D00/ACP-4020 chassis, but not IPC-3012 chassis.

\*\* Optional DVI-D cable 1700021831-01 is required.

---

## Initial Inspection

Before you begin installing your motherboard, please make sure that the following materials have been shipped:

- 1 PCE-3029 or 4129 PICMG 1.3 System Host Board
- 1 CD with utility
- 1 PCE-3029/PCE-4129 start-up manual
- 1 Serial ATA HDD data cable
- 1 Serial ATA HDD power cable
- 1 2-port COM cable kit
- 1 4-port USB 2.0 cable kit
- 1 2-port USB 3.0 cable kit
- 1 1-port LPT cable kit
- Power converter (Connecting from peripheral power connector on power supply to PWR1 onboard)
- 1 Keyboard and mouse Y cable
- 1 Jumper package
- 1 Warranty card

If any of these items are missing or damaged, contact your distributor or sales representative immediately. We have carefully inspected the PCE-3029/4129 mechanically and electrically before shipment. It should be free of marks and scratches and in perfect working order upon receipt. As you unpack the PCE-3029/4129, check it for signs of shipping damage. (For example, damaged box, scratches, dents, etc.) If it is damaged or it fails to meet the specifications, notify our service department or your local sales representative immediately. Also notify the carrier. Retain the shipping carton and packing material for inspection by the carrier. After inspection, we will make arrangements to repair or replace the unit.

# Contents

## Chapter 1 Hardware Configuration .....1

1.1	Introduction .....	2
1.2	Features & Benefits.....	2
1.3	Specifications .....	3
1.3.1	System .....	3
1.3.2	Memory .....	3
1.3.3	Input/Output .....	3
1.3.4	Graphics.....	4
1.3.5	Ethernet LAN .....	4
1.3.6	Industrial Features .....	4
1.3.7	Mechanical and Environmental Specifications.....	4
1.4	Jumpers and Connectors .....	5
	Table 1.1: Jumper List.....	5
	Table 1.2: Connectors .....	5
1.5	Board Layout: Jumper and Connector Locations.....	6
	Figure 1.1 Jumper and connector locations.....	6
1.6	Block Diagram.....	7
	Figure 1.2 PCE-3029 Block Diagram.....	7
	Figure 1.3 PCE-4129 Block Diagram.....	7
1.7	Safety Precautions .....	8
1.8	Jumper Settings .....	8
1.8.1	How to Set Jumpers.....	8
1.8.2	BIOS (JCMOS1) .....	9
	Table 1.3: Clear BIOS CMOS (JCMOS1).....	9
1.8.3	ME Enable (JME1).....	9
	Table 1.4: JCMOS1/JME1: Clear CMOS/ME Data .....	9
1.8.4	Watchdog Timer Output (JWDT1) and Hardware Monitor Alarm (JOBS1) .....	9
	Table 1.5: Watch Dog Timer (JWDT1) and Hardware Monitor Alarm (JOBS1) .....	10
1.9	System Memory .....	10

## Chapter 2 Connecting Peripherals .....11

2.1	Introduction .....	12
2.2	Parallel Port (LPT1).....	12
2.3	USB Ports (USB1, USB23, USB45, USB67, USB89, USB11).....	13
2.4	VGA Connector (VGA1) .....	14
2.5	DVI Connector (DVI1) .....	14
2.6	RS-232 Serial Ports (COM12).....	15
2.7	PS/2 Keyboard and Mouse Connector (KBMS1) .....	15
2.8	CPU Fan Connector (CPUFAN1).....	16
2.9	Front Panel Connectors (FP1) .....	17
2.10	H/W Monitor/Watchdog Timer.....	18
	2.10.1 H/W monitor alarm (JOBS1) .....	18
	2.10.2 Watchdog timer (JWDT1) .....	18
2.11	LAN Ports (LAN1 & LAN2) .....	19
	Table 2.1: LAN LED Indicators .....	19
2.12	High Definition Audio Module Interface (HDAUD1).....	20
2.13	GPIO Header (GPIO1) .....	21
2.14	Case Open Connector (JCASE1) .....	21
2.15	Front Panel LAN Indicator Connector (LANLED1).....	22
	Table 2.2: LAN LED Indicators .....	22
2.16	Serial ATA Interface (SATA0~SATA3).....	23

2.17	LPC Extension Interface (LPC1).....	24
2.18	12/5V Power Connector (PWR1).....	25
2.19	M-SATA or Mini-PCle .....	26

## **Chapter 3 AMI BIOS Setup..... 27**

3.1	Introduction .....	28
	Figure 3.1 Setup program initial screen.....	28
3.2	Entering Setup .....	29
3.2.1	Main Setup.....	29
	Figure 3.2 Main setup screen .....	29
3.2.2	Advanced BIOS Features Setup.....	30
	Figure 3.3 Advanced BIOS features setup screen .....	30
	Figure 3.4 Trust Computing.....	31
	Figure 3.5 ACPI Settings .....	32
	Figure 3.6 PCE-4129 AMT Configuration.....	33
	Figure 3.7 Firmware Update Configuration .....	34
	Figure 3.8 Smart Setting.....	35
	Figure 3.9 Super IO Configuration.....	36
	Figure 3.10 Serial Port 1 or 2 Configuration .....	36
	Figure 3.11 Parallel Configuration .....	37
	Figure 3.12 PC Health Status.....	38
	Figure 3.13 S5 RTC configuration .....	39
	Figure 3.14 Serial Port console redirection .....	40
	Figure 3.15 CPU Configuration .....	41
	Figure 3.16 Platform Misc Configuration .....	43
	Figure 3.17 SATA Configuration.....	44
	Figure 3.18 PCI Subsystem Settings.....	45
	Figure 3.19 PCI Express Settings .....	46
	Figure 3.20 USB Configuration.....	47
3.2.3	Chipset.....	48
	Figure 3.21 Chipset .....	48
	Figure 3.22 System Agent (SA) Configuration .....	48
	Figure 3.23 Graphics Configuration.....	50
	Figure 3.24 PEG Port Configuration.....	51
	Figure 3.25 Memory Information .....	52
	Figure 3.26 PCH IO Configuration.....	52
	Figure 3.27 PCI Express Configuration .....	53
	Figure 3.28 USB Configuration.....	54
	Figure 3.29 PCH Azalia Configuration.....	55
3.2.4	Security.....	56
	Figure 3.30 Security .....	56
3.2.5	Boot .....	57
	Figure 3.31 Boot.....	57
3.2.6	Save & Exit .....	58
	Figure 3.32 Save & Exit.....	58

## **Chapter 4 Value-Added Software Services ..... 59**

4.1	Value-Added Software Services .....	60
4.1.1	Software API.....	60

## **Chapter 5 Chipset Software Installation Utility 61**

5.1	Before You Begin.....	62
5.2	Introduction .....	62
5.3	Windows 7/8.1/10 Driver Setup .....	63



<b>Chapter</b>	<b>6</b>	<b>Integrated Graphic Device Setup .....</b>	<b>65</b>
	6.1	Introduction .....	66
	6.2	Windows 7/8.1/10 Driver Setup.....	66
<b>Chapter</b>	<b>7</b>	<b>LAN Configuration.....</b>	<b>67</b>
	7.1	Introduction .....	68
	7.2	Installation .....	68
	7.3	Windows 7/8.1/10 Driver Setup (LAN) .....	68
<b>Chapter</b>	<b>8</b>	<b>Intel ME .....</b>	<b>69</b>
	8.1	Introduction .....	70
	8.2	Installation .....	70
<b>Chapter</b>	<b>9</b>	<b>Intel USB 3.0.....</b>	<b>71</b>
	9.1	Introduction .....	72
	9.2	Installation .....	72
<b>Chapter</b>	<b>10</b>	<b>SATA RAID Setup .....</b>	<b>73</b>
	10.1	Introduction .....	74
	10.2	SATA RAID Driver and Utility Setup .....	74
<b>Appendix A</b>		<b>Programming the Watchdog Timer..</b>	<b>75</b>
	A.1	Introduction .....	76
	A.1.1	Watchdog timer overview.....	76
	A.1.2	Programming the watchdog timer .....	76
		Table A.1: Watchdog Timer Registers .....	77
	A.1.3	Example program.....	78
<b>Appendix B</b>		<b>I/O Pin Assignments.....</b>	<b>83</b>
	B.1	Parallel Port Connector (LPT1) .....	84
		Table B.1: Parallel Port Connector (LPT1) .....	84
	B.2	VGA Connector (VGA1) .....	84
		Table B.2: VGA Connector (VGA1) .....	84
	B.3	RS 232 Serial Port (COM12).....	85
		Table B.3: RS-232 Serial Port (COM12).....	85
	B.4	USB 3.0 Header (USB23~USB89).....	86
		Table B.4: USB 3.0 Header (USB23~USB89) .....	86
	B.5	PS/2 Keyboard/Mouse Connector (KBMS1) .....	86
		Table B.5: PS/2 Keyboard/Mouse Connector (KBMS1) .....	86
	B.6	CPU Fan Power Connector (CPUFAN1) .....	87
		Table B.6: CPU Fan Power Connector (CPUFAN1) .....	87
	B.7	Front Panel Connector (FP1) .....	87
		Table B.7: Front Panel Connector (FP1) .....	87
	B.8	High-definition Audio Link Connector (HDAUD1).....	88
		Table B.8: High-definition Audio Link Connector (HDAUD1) .....	88
	B.9	LAN1 and LAN2 LED Connector (LANLED1) .....	88
		Table B.9: LAN1 and LAN2 LED Connector (LANLED1).....	88

B.10	GPIO Header (GPIO1).....	89
	Table B.10:GPIO Header (GPIO1) .....	89
B.11	JWDT1 and JOBS1.....	89
	Table B.11:JWDT1 and JOBS1 .....	89
B.12	JCASE1 .....	90
	Table B.12:JCASE1 .....	90
B.13	LPC1 .....	90
	Table B.13:LPC1 .....	90
B.14	PWR1.....	91
	Table B.14:PWR1 .....	91
B.15	DP1, DVI1 .....	91
	Table B.15:DP1, DVI1 .....	91
B.16	Fixed I/O Ranges Decoded by Intel PCH .....	92
	Table B.16:Fixed I/O Ranges Decoded by PCH.....	92
B.17	System I/O Ports.....	93
	Table B.17:System I/O Ports .....	93
B.18	Interrupt Assignments .....	93
	Table B.18:Interrupt Assignments .....	93
B.19	1 MB Memory Map.....	94
	Table B.19:1 MB memory map .....	94

## **Appendix C      Programming the GPIO ..... 95**

C.1	Supported GPIO Register .....	96
C.2	GPIO Registers.....	96
C.3	GPIO Example Program-1 .....	96

# Chapter 1

Hardware  
Configuration

## 1.1 Introduction

PCE-3029/4129 is a PICMG 1.3 half-size system host board which is designed with Intel® H110 (PCE-3029) or C236 (PCE-4129) PCH for industrial applications that 14nm manufacturing technology, LGA1151 socket Intel® Xeon or Core™ i7/i5/i3, Pentium® and Celeron® processors that integrate memory and graphic controllers and supports DDR4 2133 SDRAM up to 32 GB. With advanced computing technology, PCE-3029/4129 is the best high performance compact system solutions.

PCE-3029/4129 performs excellent graphic capability through its integrated Intel® HD Graphics core. With this, PCE-3029/4129 provides strong 2D/3D graphic processing power without an additional graphic card to save extra cost, power consumption and thermal integration effort. Besides, PCE-3029/4129 supports various display interfaces to enhance flexibility for system integrators.

PCE-3029/4129 also has rich expansion interfaces which support Advantech PCE-3BXX and 4BXX backplanes to offer both PCI and PCIe lanes. This fulfills different applications, such as manufacturing automation, factory automation, automatic optical inspection, and medical equipment.

In addition, PCE-3029/4129 provides new SATA Gen3 (600MB/sec) ports, satisfy high data applications, like storage and data management center. PCE-4129's SATA ports support software RAID 0, 1, 5, 10 as a cost-effective and reliable data solution. USB 3.0 ports reach 5 Gbps high data rates and RS-232, RS-422, RS-485 and parallel ports are for industrial control applications. With flexible I/O interfaces, PCE-3029/4129 can be an excellent, graphic or I/O processing platform with outstanding performance and exceptional features. They are also the most ideal computing cores for advanced compact-sized industrial next generation applications.

## 1.2 Features & Benefits

- **Processor support:** Intel 6th generation family processors with the latest 14nm lithography.
- **DDR4 1866/2133 up to 32 GB:** DDR4 provides up to 50 percent increased performance and bandwidth while saving up to 40 percent power.
- **Storage:** Support SATA 3.0 ports with SW raid 0, 1, 5, 10 support.
- **High Performance I/O capability:** Provide high transfer data performance interface; USB 3.0 data transfer rate is 5 Gbps which is 10 times faster than USB2.0.
- **PCIe architecture:** Processor support 16 links of PCI Express generation 3.0 and PCH support 4 links of PCI Express generation 3.0 to PICMG1.3 backplanes.
- **SUSI API:** Support SUSIAccess and Intelligent system module for remote management.

## 1.3 Specifications

### 1.3.1 System

- **CPU:** LGA1151-socket Core i7/i5/i3, Pentium and Xeon E3-1200v5 series processors
- **L2 Cache:** Please refer to CPU specification for detailed information.
- **BIOS:** AMI SPI BIOS (128 Mb SPI)
- **System Chipset:** Intel C236 (PCE-4129); Intel H110 (PCE-3029)
- **SATA hard disk drive interface:** PCE-3029 supports three SATA 3.0 ports, and PCE-4129 supports four SATA 3.0 ports.

**Note!** PCE-3029/4129 do NOT support PATA(IDE) interface.



Only PCE-4129 supports Intel Xeon processors.

### 1.3.2 Memory

- **RAM:**
  - PCE-4129: Up to 32 GB in two 260-pin SO-DIMM sockets. Supports dual-channel DDR4 1866/2133 SDRAM WITH or WITHOUT ECC function.
  - PCE-3029: Up to 32 GB in two 260-pin SO-DIMM sockets. Supports dual-channel DDR4 1866/2133 SDRAM WITHOUT ECC function.

- Note!**
1. Due to the inherent limitations of the PC architecture, the system may not fully detect 16 GB RAM when 16 GB of RAM is installed.
  2. A 32-bit OS may not fully detect 4 GB of RAM when 4 GB is installed.



Please select Intel ECC supported processor to enable ECC function.

### 1.3.3 Input/Output

- **PCIe bus:** One PCIe x16 or Two PCIe x8 from CPU and One PCIe x4 from PCH.
- **Enhanced parallel port:** This EPP/SPP/ECP port can be configured to LPT1 or disabled. A standard DB-25 female connector provided.
- **Serial ports:** Two RS-232 serial ports
- **PS/2 keyboard and mouse connector:** One 6-pin mini-DIN connectors is located on the mounting bracket for easy connection to a PS/2 keyboard and mouse via the Y-cable included in the package.
- **USB port:** 7 x USB 2.0 (480Mbps) and 3 x USB 3.0 (5Gbps)
- **LPC:** One LPC connector to support optional TPM (PCA-TPM-00A1E), COM-232 (PCA-COM232-00A1E), COM-422/485 (PCA-COM485-00A1E) modules.
- **GPIO:** Supports 8-bit GPIO from super I/O for general purpose control application.

### 1.3.4 Graphics

- **Controller:** Intel® HD Graphics embedded in the processor.
- **Display memory:** Shared memory is subject to OS (install 2 GB or above memory for basic system configuration).
- **CRT:** Up to 1920 x 1200 @ 60 Hz
- **DVI-D:** Up to 1920x1200 @60Hz.
- **Other display:** Supports VGA + Display Port. Display type depends on optional stack board.
- **PCI express x16/x8 slot on the backplane:** An external graphic card can be installed in the PCIe x16 / x8 slot for high 2D/3D graphics capability.

### 1.3.5 Ethernet LAN

- Supports single/dual 10/100/1000 Mbps Ethernet port(s) via the dedicated PCI Express x1 bus which provides 500 MB/s data transmission rate.
- **Controller:**
  - LAN 1: Intel® I219V (PCE-3029) and I219LM (PCE-4129).
  - LAN 2: Intel® I211AT(PCE-3029) and I210AT (PCE-4129).

### 1.3.6 Industrial Features

- **Watchdog timer:** Can generate a system reset. The watchdog timer is programmable, with each unit equal to one second or one minute (255 levels).

### 1.3.7 Mechanical and Environmental Specifications

- **Operating temperature:** 0 ~ 60° C (32 ~ 140° F, depending on CPU and thermal solution)
- **Storage temperature:** -40 ~ 85° C (-40 ~ 185° F)
- **Operating humidity:** 40° C @ 85% RH, non-Condensing
- **Non-operating humidity:** 60° C @ 95% RH, non-Condensing
- **Power supply voltage:** +3.3 V, +5 V, +12 V, +5 V<sub>SB</sub>
- **Power consumption:**

---

#### PCE-3029

Intel Core i7-6700 (3.4GHz), DDR4 2133 8GB \*2

Voltage	12V	5V	3.3V	5VSB	-12V	-5V
Current	4.6	0.01	0.32	0.08	0	0

---

#### PCE-4129

Intel Xeon E3-1225 v5 (3.30GHz), DDR4 2133 8GB \*2

Voltage	12V	5V	3.3V	5VSB	-12V	-5V
Current	4.6	0.01	0.32	0.08	0	0

- **Board size:** 167.64 mm x 126.39 mm (6.6" x 4.98")
- **Board weight:** 0.33 kg (Weight of board)

## 1.4 Jumpers and Connectors

Connectors on the PCE-3029/4129 single host board link it to external devices such as hard disk drives and a keyboard. In addition, the board has a number of jumpers used to configure your system for your application.

The tables below list the function of each of jumpers and connectors. Later sections in this chapter give instructions on setting jumpers. Chapter 2 gives instructions for connecting external devices to your motherboard.

**Table 1.1: Jumper List**

Label	Function
JCMOS1	CMOS clear
JME1	Enable ME
JWDT1 JOBS1	Watchdog timer output selection and HW monitor alarm

**Table 1.2: Connectors**

Label	Function
LPT1	Parallel port, Parallel port x 1, supports SPP/EPP/ECP mode
LAN1	Intel I219V (PCE-3029); Intel I219LM (PCE-4129)
LAN2	Intel I211AT (PCE-3029); Intel I210AT (PCE-4129)
VGA1	VGA connector
KBMS1	PS/2 keyboard and mouse connector
COM12	Serial port: COM1 (RS-232), and COM2 (RS-232)
FP1	HDD LED, power LED, SNMP SM_Bus, reset, power on/off
JCASE1	Case Open
CPUFAN1	CPU FAN connector (4-pin)
LANLED1	LAN1/2 LED extension connector
HDAUD1	HD audio extension module connector
USB1	USB port 1 on rear I/O (3.0)
USB23	USB port 2, 3 with box header (3.0)
USB45, USB67, USB89	USB port 4 ~ 9 with box header (2.0)
USB11	USB port 11 with type A connector (2.0)
SATA0	Serial ATA1 (3.0)
SATA1	Serial ATA2 (3.0)
SATA2	Serial ATA3 (3.0)
SATA3	Serial ATA4 (PCE-4129: 3.0)
CPU1	CPU Socket
DIMMA1	Memory connector channel A
DIMMB1	Memory connector channel B
GPIO1	GPIO pin header (SMD pitch-2.0 mm)
LPC1	COM port module expansion pin-header
PWR1	12 V, 5 V, power connector
DVI1	DVI connector
DP1	Display pin header to stack board (Display type depends on optional stack board)
EXPCIE1	Mini PCIe pin header to stack board
MINIPCIE MSATA	M-SATA (default) or mini-PCIe connector (optional for PCE-4129)

## 1.5 Board Layout: Jumper and Connector Locations

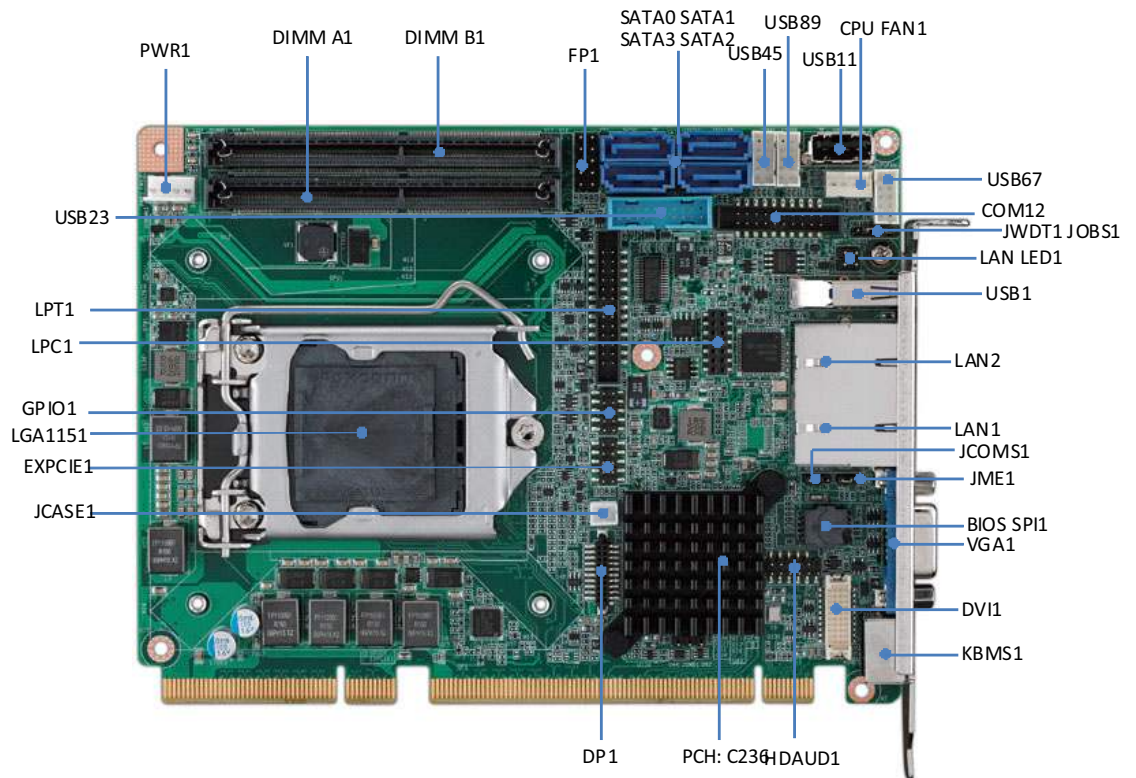
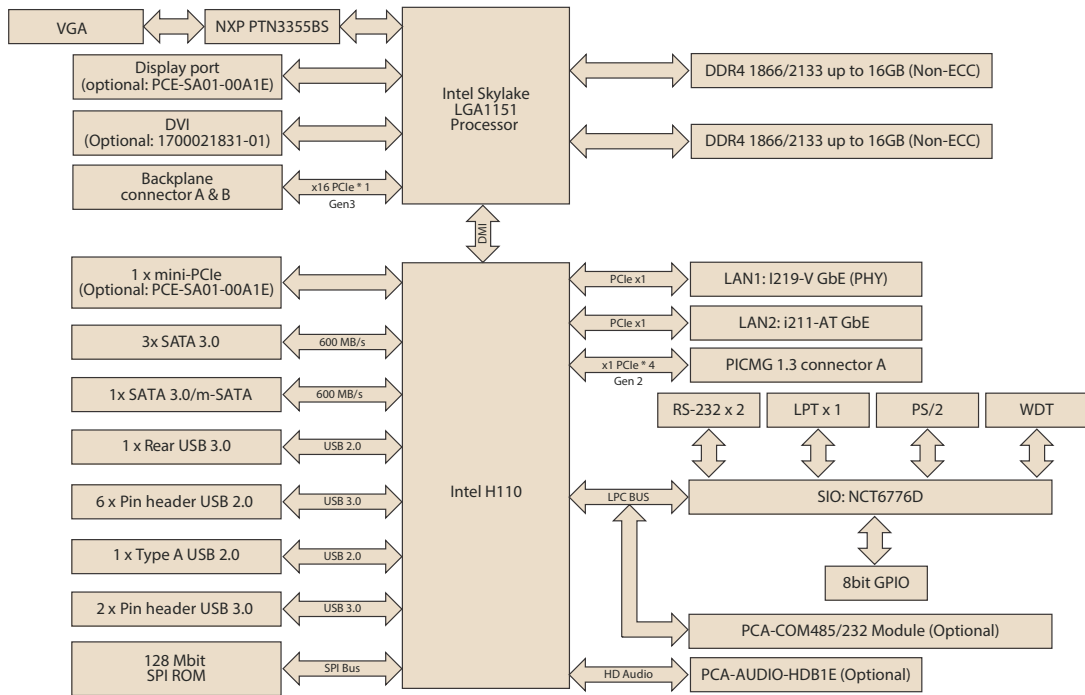

Figure 1.1 Jumper and connector locations



## 1.6 Block Diagram



**Figure 1.2 PCE-3029 Block Diagram**

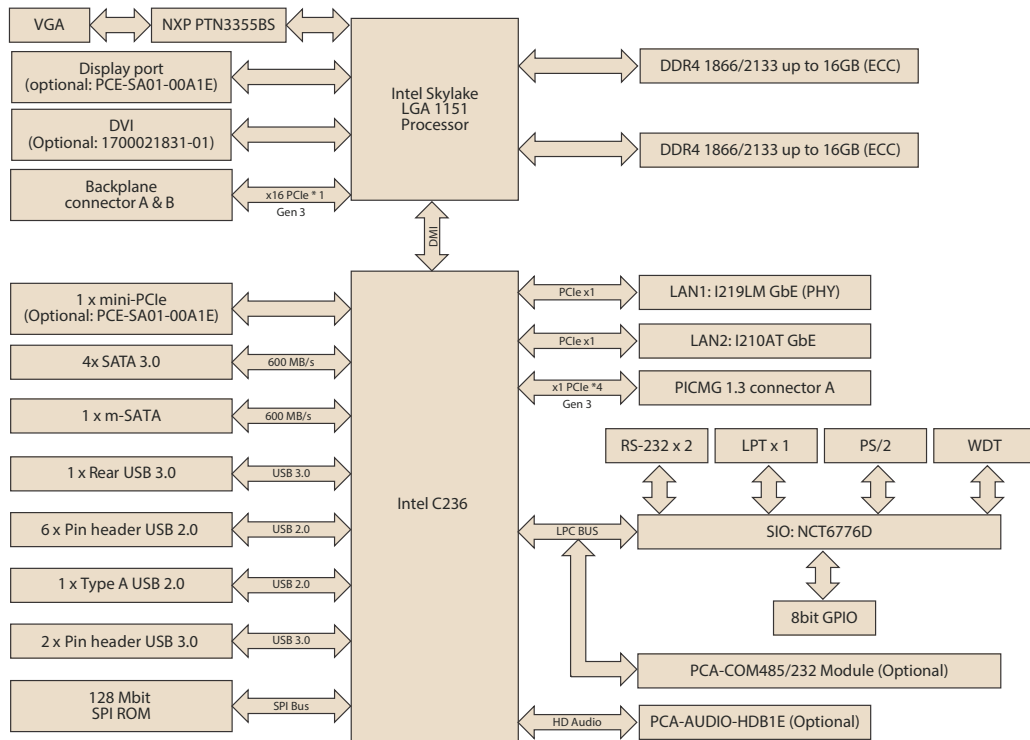

**Figure 1.3 PCE-4129 Block Diagram**

## 1.7 Safety Precautions

**Warning!** Always completely disconnect the power cord from your chassis whenever you work with the hardware. Do not make connections while the power is on. Sensitive electronic components can be damaged by sudden power surges. Only experienced electronics personnel should open the PC chassis.



**Caution!** Always ground yourself to remove any static charge before touching the motherboard. Modern electronic devices are very sensitive to static electrical discharges. As a safety precaution, use a grounding wrist strap at all times. Place all electronic components on a static-dissipative surface or in a static-shielded bag when they are not in the chassis.



**Caution!** The computer is provided with a battery-powered Real-time Clock. There is a danger of explosion if battery is incorrectly replaced. Replace only with same or equivalent type recommended by the manufacturer. Discard used batteries according to manufacturer's instructions.



**Caution!** There is a danger of a new battery exploding if it is incorrectly installed. Do not attempt to recharge, force open or heat the battery. Replace the battery only with the same or equivalent type recommended by the manufacturer. Discard used batteries according to the manufacturer's instructions.



## 1.8 Jumper Settings

This section provides instructions on how to configure your motherboard by setting the jumpers. It also includes the motherboard's default settings and your options for each jumper.

### 1.8.1 How to Set Jumpers

You can configure your motherboard to match the needs of your application by setting the jumpers. A jumper is a metal bridge that closes an electrical circuit. It consists of two metal pins and a small metal clip (often protected by a plastic cover) that slides over the pins to connect them. To “close” (or turn ON) a jumper, you connect the pins with the clip. To “open” (or turn OFF) a jumper, you remove the clip. Sometimes a jumper consists of a set of three pins, labeled 1, 2 and 3. In this case you connect either pins 1 and 2, or 2 and 3. A pair of needle-nose pliers may be useful when setting jumpers.

## 1.8.2 BIOS (JCMOS1)

PCE-3029/4129 CPU card contains a jumper that can erase BIOS CMOS data and reset the system BIOS information. Normally this jumper should be set with pins 1-2 closed. If you want to reset those data, set JCMOS1 to 2-3 closed for just a few seconds, and then move the jumper back to 1-2 closed. This procedure will reset the CMOS to its last status or default setting.

**Table 1.3: Clear BIOS CMOS (JCMOS1)**

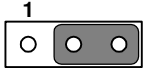
Function	Jumper Setting
*Keep BIOS CMOS data	 1-2 closed
Clear BIOS CMOS data	 2-3 closed
* default setting	

## 1.8.3 ME Enable (JME1)

PCE-3029/4129 CPU card contains a jumper that can enable ME data. Normally this jumper should be set with pins 1-2 closed, then you can see ME information shows in BIOS menu and ME can be updated, too. If you want to disable the function of ME update, set JME1 to 2-3 closed.

**Table 1.4: JCMOS1/JME1: Clear CMOS/ME Data**

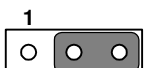
Function	Jumper Setting
* ME enable	 1-2 closed
ME disable	 2-3 closed
* default setting	

## 1.8.4 Watchdog Timer Output (JWDT1) and Hardware Monitor Alarm (JOBS1)

PCE-3029/4129 contains a watchdog timer that will reset the CPU in the event the CPU stops processing. This feature means PCE-3029/4129 will recover from a software failure or an EMI problem. The JWDT1 jumper settings control the outcome of what the computer will do in the event the watchdog timer is tripped.

PCE-3029/4129 also provide jumper: JOBS1 to enable or disable hardware monitor alarm.

**Table 1.5: Watch Dog Timer (JWDT1) and Hardware Monitor Alarm (JOBS1)**

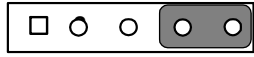
Function	Jumper Setting
*Enable watch dog timer	<div style="text-align: center;">1</div>  <div style="float: right;">2-3 closed</div>
*Enable hardware monitor alarm	<div style="text-align: center;">1</div>  <div style="float: right;">4-5 closed</div>

\* default setting

## 1.9 System Memory

PCE-3029/4129 has two 260-pin memory sockets for DDR4 1866/2133 MHz memory modules with maximum capacity of 32 GB. (Maximum 16 GB for each DIMM)

**Note!** Both of PCE-3029 and PCE-4129 do NOT support registered DIMMs (RDIMMs).



# Chapter 2

Connecting  
Peripherals

## 2.1 Introduction

You can access most of the connectors from the top of the board. If you have a number of cards installed, you may need to partially remove a card to make all the connections.

## 2.2 Parallel Port (LPT1)

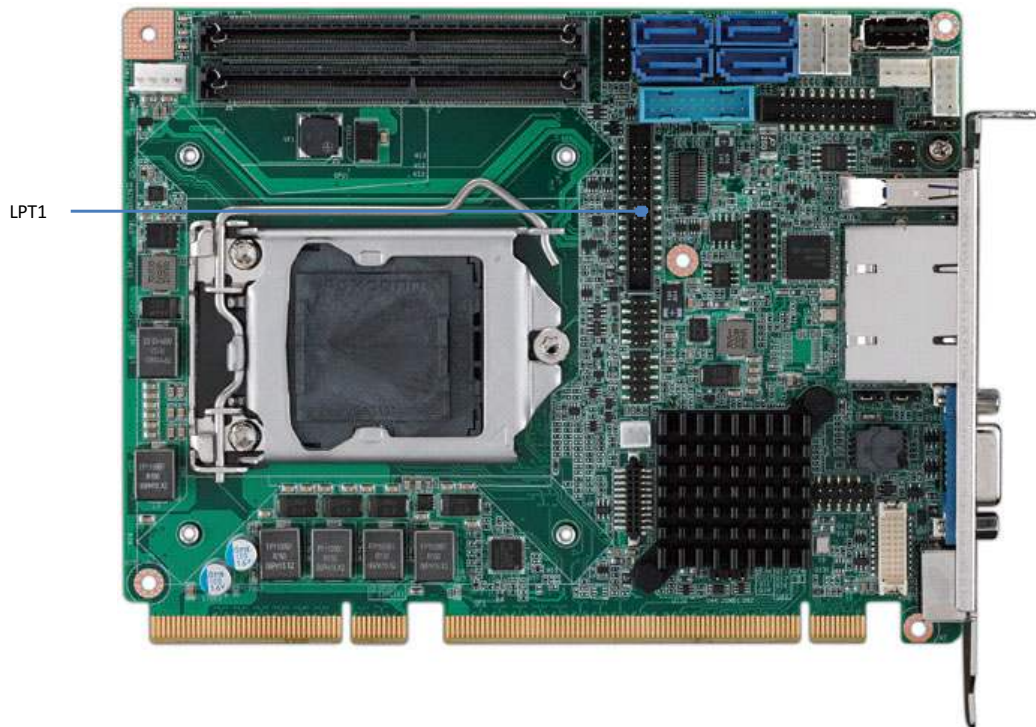

The parallel port is normally used to connect the motherboard to a printer. PCE-3029/4129 includes an onboard parallel port, accessed through a 26-pin flat-cable connector, LPT1.

## 2.3 USB Ports (USB1, USB23, USB45, USB67, USB89, USB11)

PCE-3029/4129 provides up to 10 x USB (Universal Serial Bus) on-board ports with complete Plug & Play and hot swap support. These USB ports comply with USB Specification 2.0 and 3.0, support transfer rates up to 480 Mbps (USB2.0), and 5 Gbps (USB3.0). USB 2, 3, 4, 5, 6, 7, 8 and 9 ports are located on board with box header, USB11 is a type A connector, and USB1 is on rear I/O bracket.

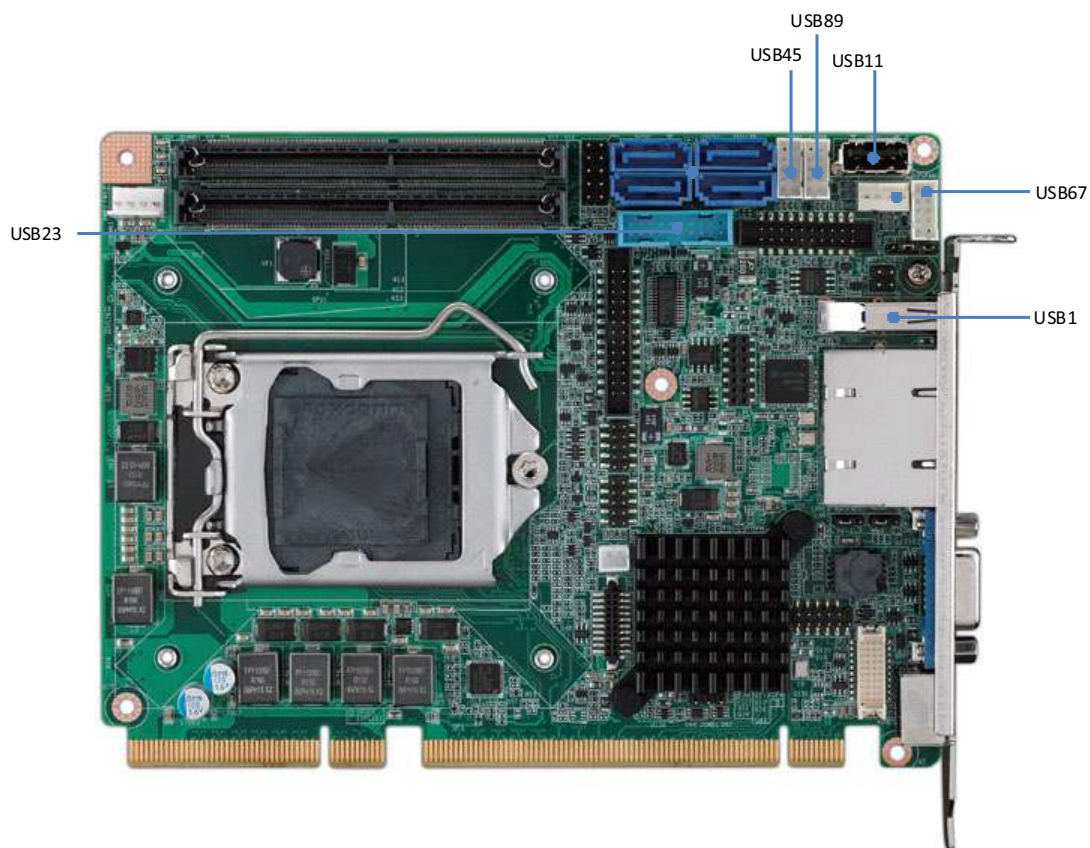

## 2.4 VGA Connector (VGA1)

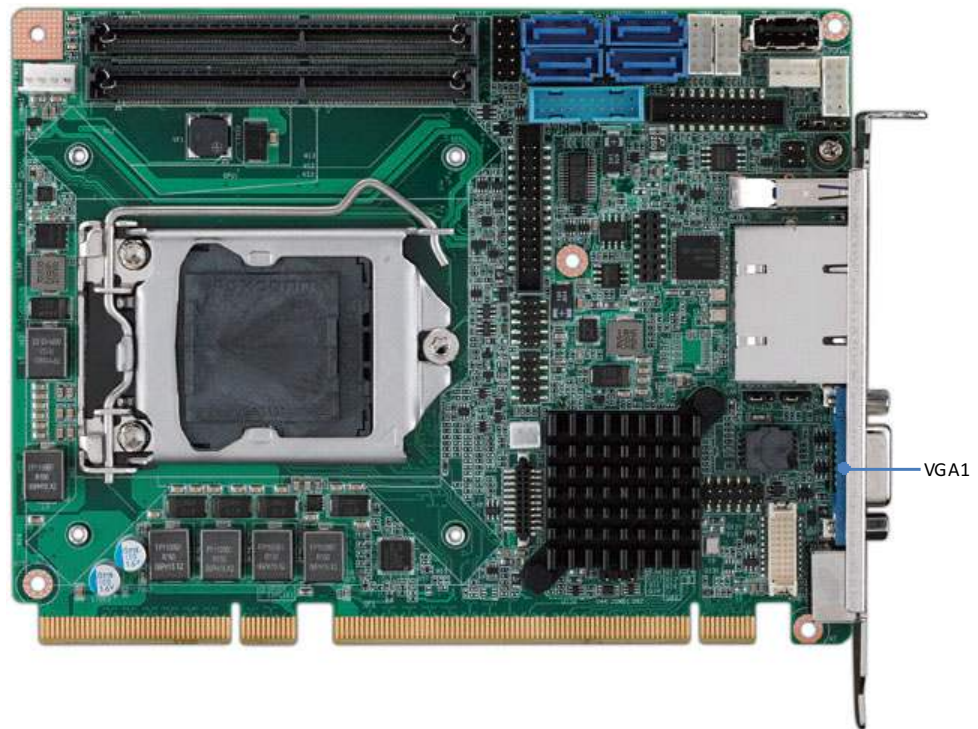

This CPU card has VGA outputs that can drive conventional CRT displays. VGA1 is a standard 15-pin D-SUB connector commonly used for VGA.

## 2.5 DVI Connector (DVI1)



DVI1 is a 20-pin connector, supporting resolution up to 1920 x 1200. Please place order no. 1700021831-01 for standard DVI connector on bracket.



## 2.6 RS-232 Serial Ports (COM12)



PCE-3029/4129 offers two serial ports. These ports can connect to serial devices, such as a mouse or a printer, or to a communications network. The IRQ and address ranges for both ports are fixed. However, if you want to disable the port or change these parameters later, you can do this in the system BIOS setup.

## 2.7 PS/2 Keyboard and Mouse Connector (KBMS1)



Two on-board 6-pin mini-DIN connectors (KBMS1) provide connection to PS/2 keyboard.

## 2.8 CPU Fan Connector (CPUFAN1)

This connector supports cooling fans of 500 mA (6 W) or less, and it also supports smart fan control when using 4-pin or 3-pin cooler.

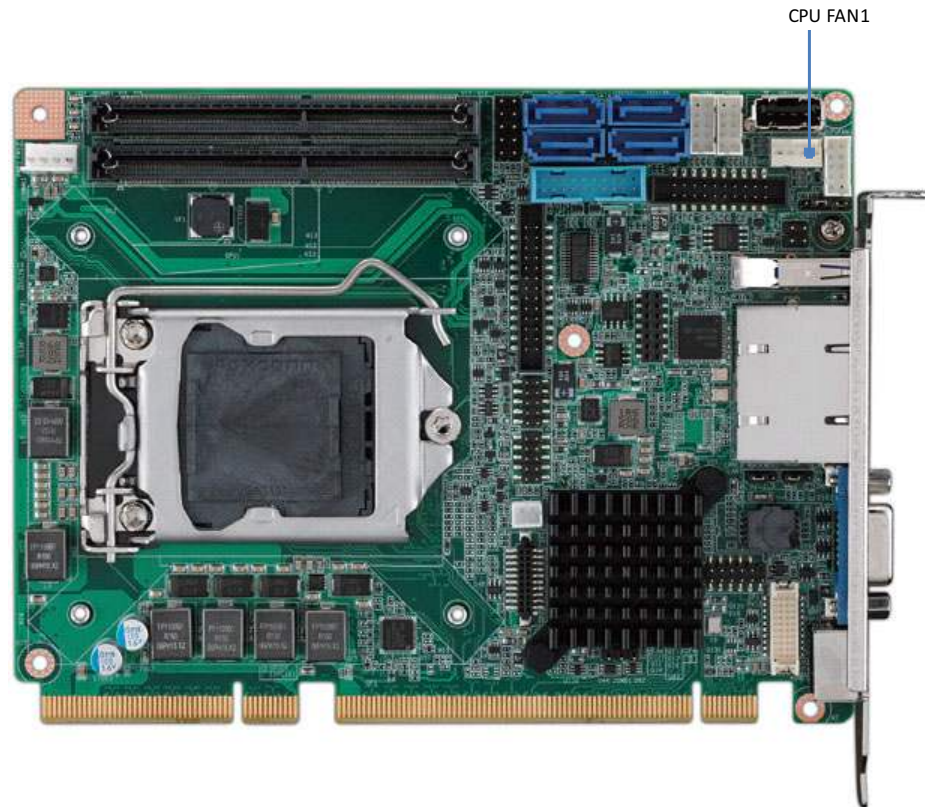

## 2.9 Front Panel Connectors (FP1)

FP1 is a 10-pin connector which connects to the front panel switch to control system HDD LED, power LED, SNMP SM\_Bus, reset, power on/off.



Power status	Power LED status			
	AT		ATX	
	Deep S5 ON	Deep S5 OFF	Deep S5 ON	Deep S5 OFF
S0	On	On	On	On
S1	Flash(fast)	Flash(fast)	Flash(fast)	Flash(fast)
S2	-	-	-	-
S3	Flash(fast)	Flash(fast)	Flash(fast)	Flash(fast)
S4	Flash(slow)	Flash(slow)	Off	Flash(slow)
S5	Off	Off	Off	Off

## 2.10 H/W Monitor/Watchdog Timer

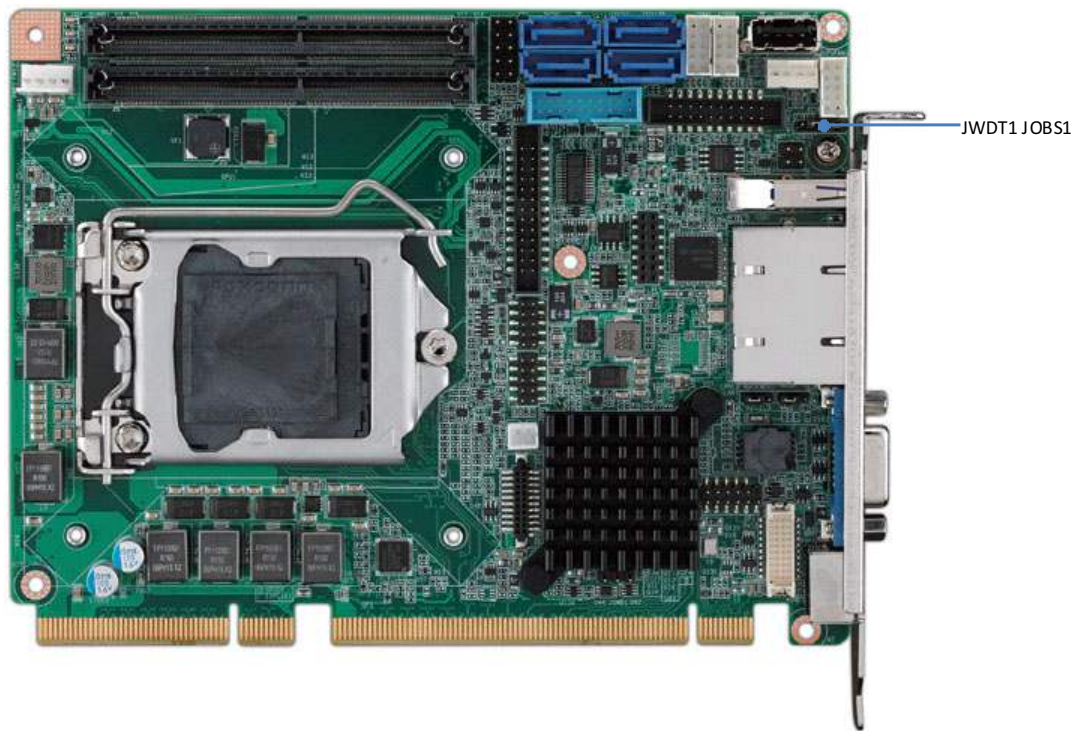

### 2.10.1 H/W monitor alarm (JOBS1)

This 2-pin header is for enabling/disabling H/W monitor alarm function.

4-5 Closed: Enables hardware monitor alarm (Default)

4-5 Open: Disables hardware monitor alarm

### 2.10.2 Watchdog timer (JWDT1)

This is for a setting action trigger on the watchdog timer.

2-3 Close: Enable watchdog timer (Default)

2-3 Open: No action

## 2.11 LAN Ports (LAN1 & LAN2)

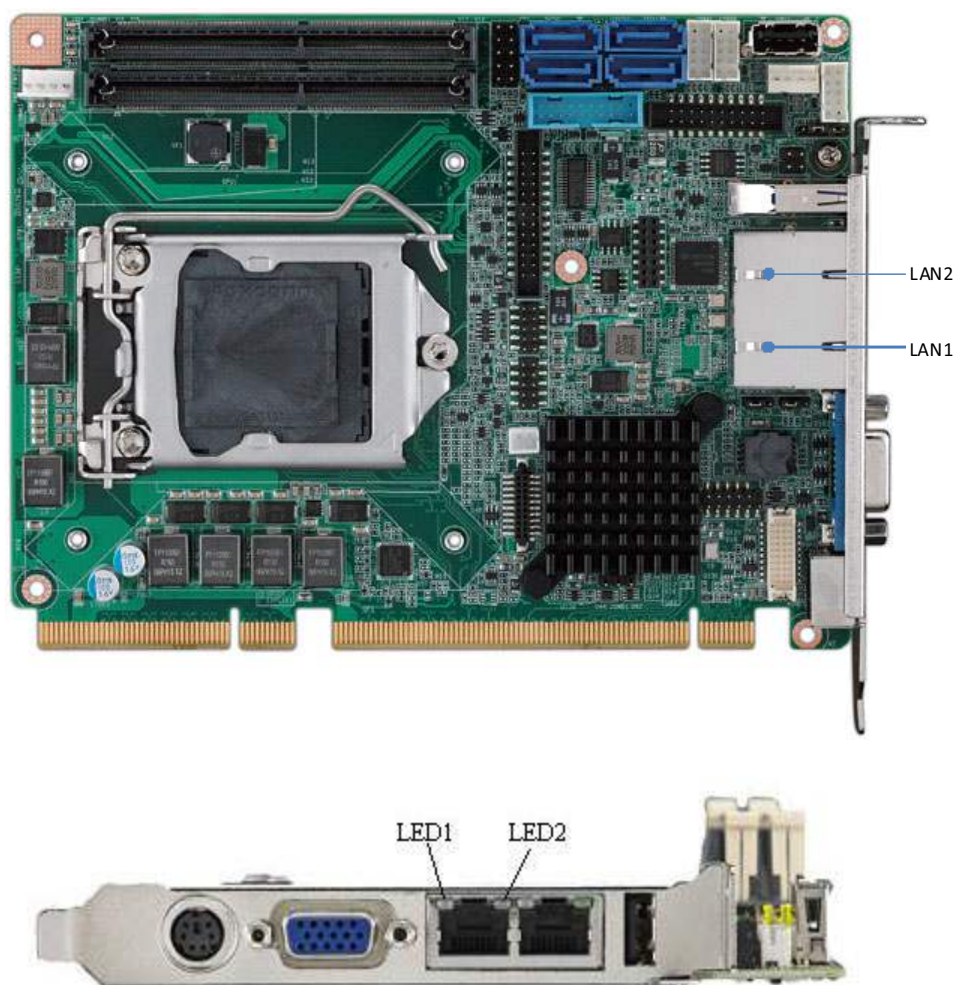

PCE-3029/4129 is equipped with two high-performance 1000 Mbps Ethernet LANs. They are supported by all major network operating systems. The RJ-45 jacks on the rear plate provide convenient connectivity.

**Table 2.1: LAN LED Indicators**

LAN Mode	LED1	LED2
1000Mbps Link On	Green On	On
1000Mbps Active	Green On	Flash
1000Mbps Link Off	Off	Off
100Mbps Link On	Orange On	On
100Mbps Active	Orange On	Flash
100Mbps Link Off	Off	Off
10Mbps Link On	Off	On
10Mbps Active	Off	Flash
10Mbps Link Off	Off	Off

## 2.12 High Definition Audio Module Interface (HDAUD1)

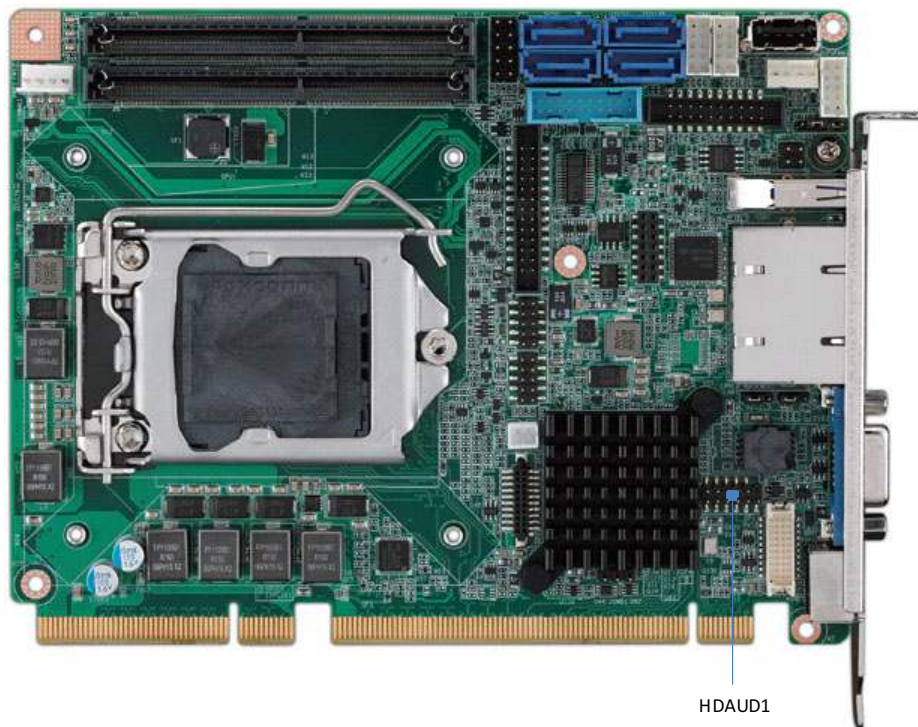

This HDAUD1 pin header is the connection interface to Advantech's audio module.

**Note!** *Advantech audio module ordering information.*



*P/N: PCA-AUDIO-HDB1E.*

## 2.13 GPIO Header (GPIO1)

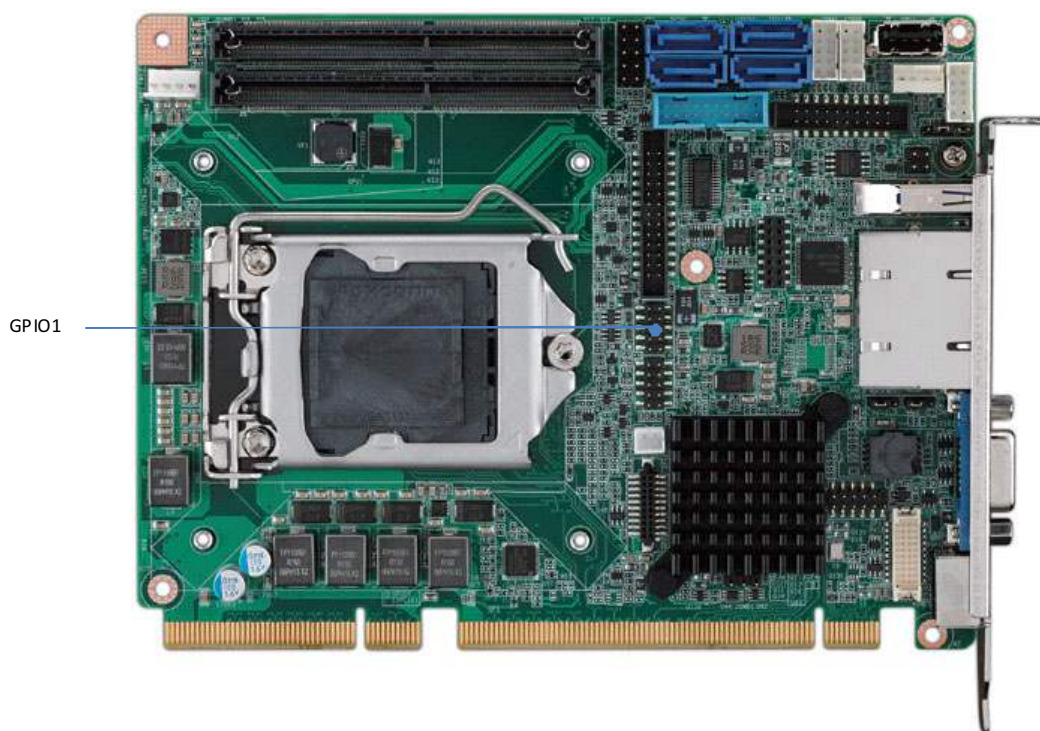

Provides 10-Pin pin header for 8-bit Digital I/O usage. Refer to Appendix B for detailed information on the pin assignments and programming guide in Appendix C.

## 2.14 Case Open Connector (JCASE1)



The 2-pin case open connector is for chassis with a case open sensor. When the case is open, the buzzer on motherboard will beep.

## 2.15 Front Panel LAN Indicator Connector (LANLED1)

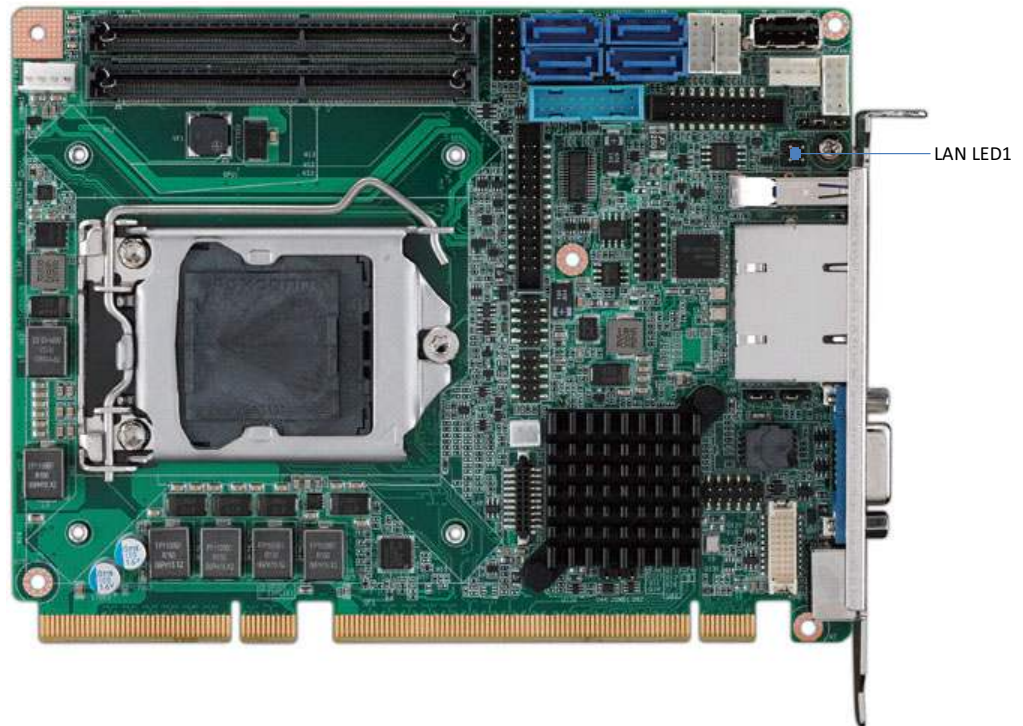

**Table 2.2: LAN LED Indicators**

<b>LAN Mode</b>	<b>LAN1 (1,3 pin)</b>	<b>LAN2 (2, 4 pin)</b>
1000Mbps Link On	On	On
1000Mbps Active	Flash	Flash
1000Mbps Link Off	Off	Off
100Mbps Link On	On	On
100Mbps Active	Flash	Flash
100Mbps Link Off	Off	Off
10Mbps Link On	On	On
10Mbps Active	Flash	Flash
10Mbps Link Off	Off	Off



## 2.16 Serial ATA Interface (SATA0~SATA3)



PCE-3029/4129 features high performance serial ATA 3.0 interface which eases cabling to hard drivers or CD/DVD drivers with long cables.

## 2.17 LPC Extension Interface (LPC1)

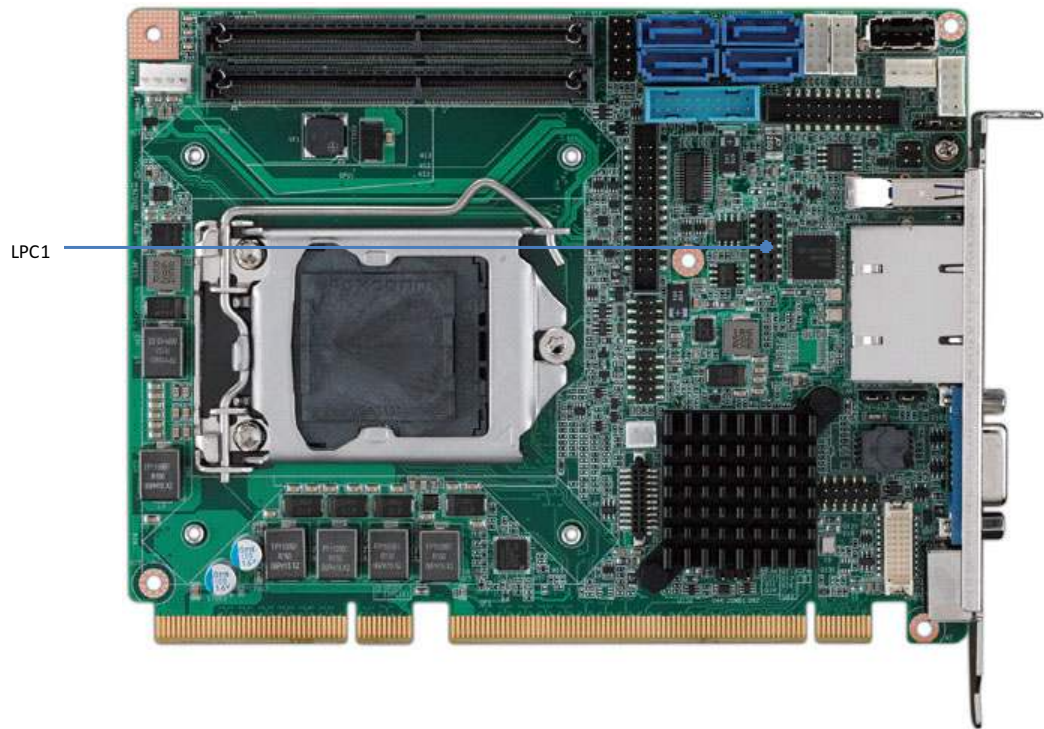

LPC1 is a 14-pin female pinheader for adopting Advantech LPC module, such as PCA-COM232-00A1E, PCA-COM485-00A1E, PCA-TPM-00A1E.

## 2.18 12/5V Power Connector (PWR1)



Due to no 5V supply from the golden fingers, please use a power converter: 1703040100 to connect from the peripheral power connector on the power supply to PWR1 on board.

**Note!** Please note that if PWR1 is not connected, PCE-3029/4129 can not be powered on.



## 2.19 M-SATA or Mini-PCle

PCE-4129 provide a m-SATA interface with 600MB/s. If you need mini-PCle device for PCE-4129, please contact with local sales or FAE for further T-part assistance.

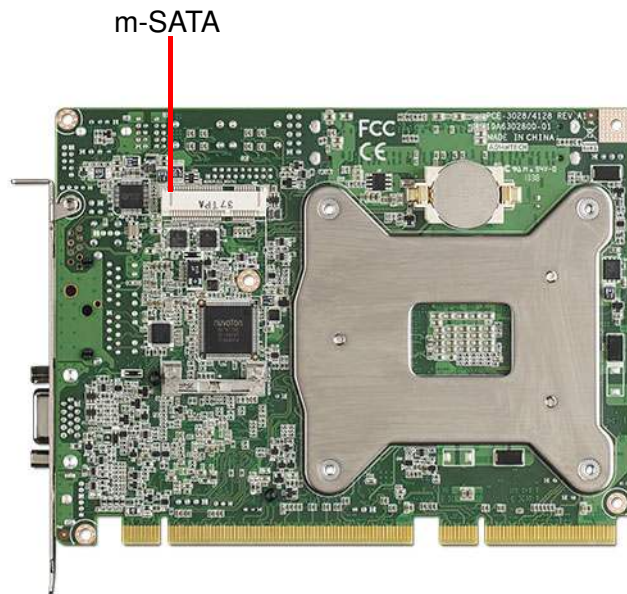

# Chapter 3

AMI BIOS Setup

## 3.1 Introduction

AMI BIOS has been integrated into motherboards for over a decade. In the past, people often referred to the AMI BIOS setup menu as BIOS, BIOS setup or CMOS setup. With the AMI BIOS Setup program, you can modify BIOS settings and control the special features of your computer. The Setup program uses a number of menus for making changes and turning the special features on or off. This chapter describes the basic navigation of the PCE-3029/4129 setup screens.

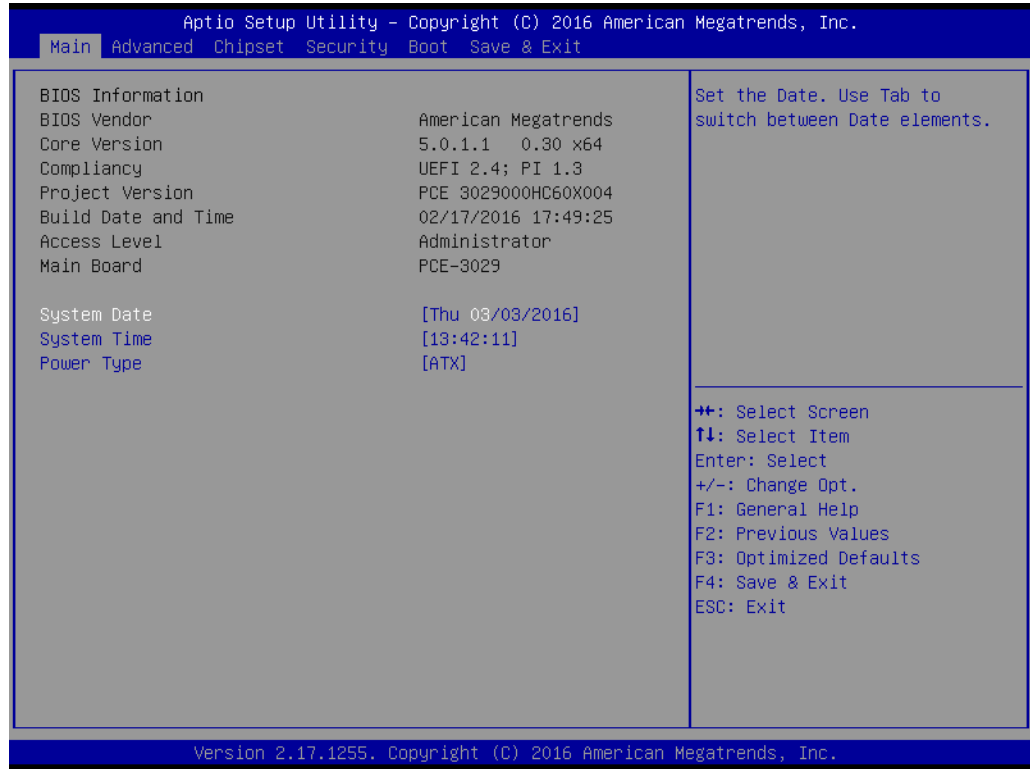

Figure 3.1 Setup program initial screen

## 3.2 Entering Setup

Turn on the computer and the BIOS is activated as well. The setup program can be triggered by pressing "DEL" or "ESC" key.

**Note!** *If the message disappears before you press the "DEL" or "ESC" key, please restart the computer and try it again.*



### 3.2.1 Main Setup

When you first enter the BIOS Setup Utility, you will enter the Main setup screen. You can always return to the Main setup screen by selecting the Main tab. There are two Main Setup options. They are described in this section. The Main BIOS Setup screen is shown below.

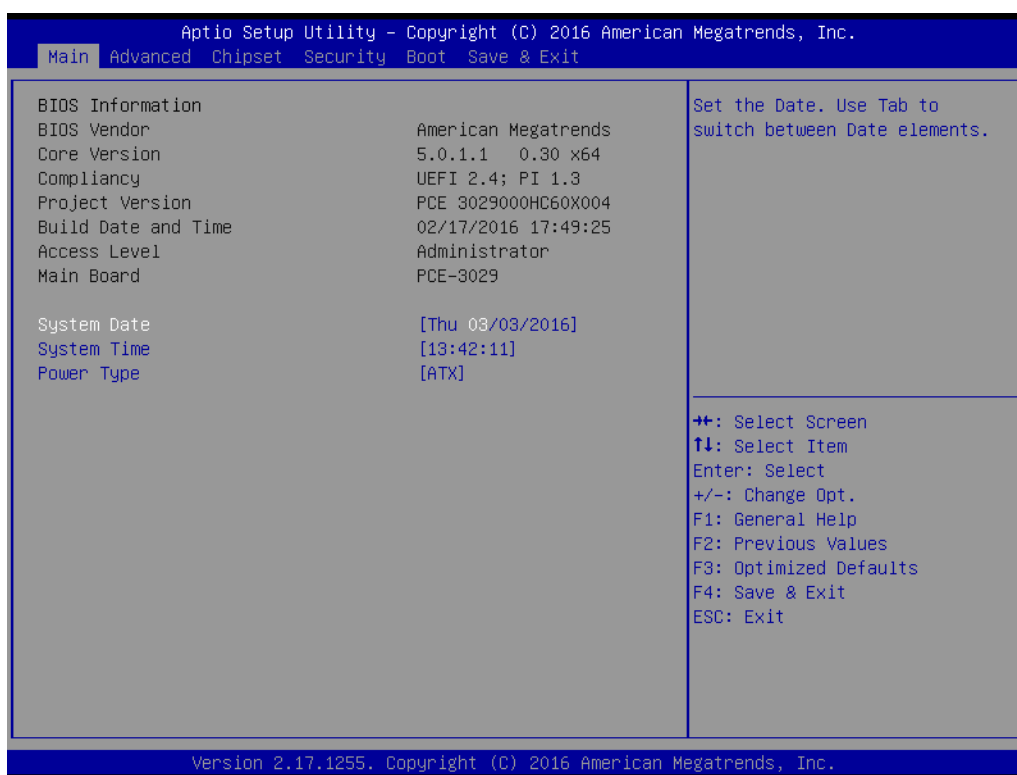

**Figure 3.2 Main setup screen**

The Main BIOS setup screen has two main frames. The left frame displays all the options that can be configured. Grayed-out options cannot be configured; options in blue can. The right frame displays the key legend.

Above the key legend is an area reserved for a text message. When an option is selected in the left frame, it is highlighted in white. Often a text message will accompany it.

- **System Time / System Date**

Use this option to change the system time and date. Highlight System Time or System Date using the <Arrow> keys. Enter new values through the keyboard. Press the <Tab> key or the <Arrow> keys to move between fields. The date must be entered in MM/DD/YY format. The time must be entered in HH:MM:SS format.

- **Power Type**

Choose this item correspond with your power supply type.

### 3.2.2 Advanced BIOS Features Setup

Select the Advanced tab from the PCE-7129/5129/5029 setup screen to enter the Advanced BIOS Setup screen. You can select any of the items in the left frame of the screen, such as CPU Configuration, to go to the sub menu for that item. You can display an Advanced BIOS Setup option by highlighting it using the <Arrow> keys. All Advanced BIOS Setup options are described in this section. The Advanced BIOS Setup screen is shown below, and the sub menus are described on the following pages.

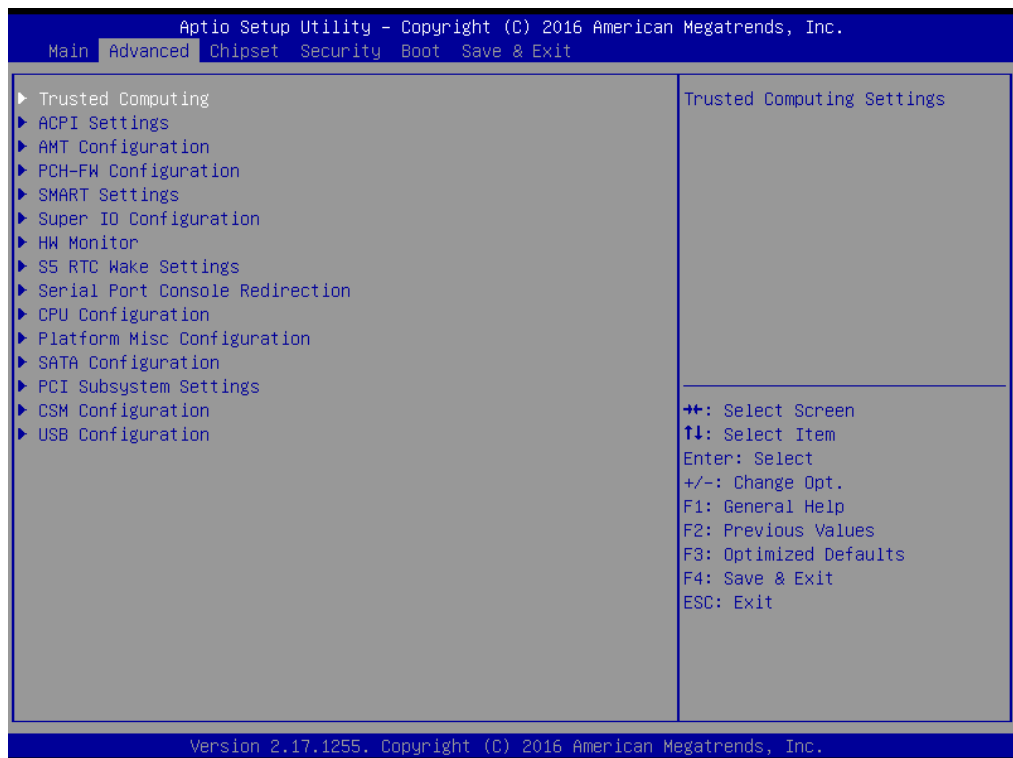
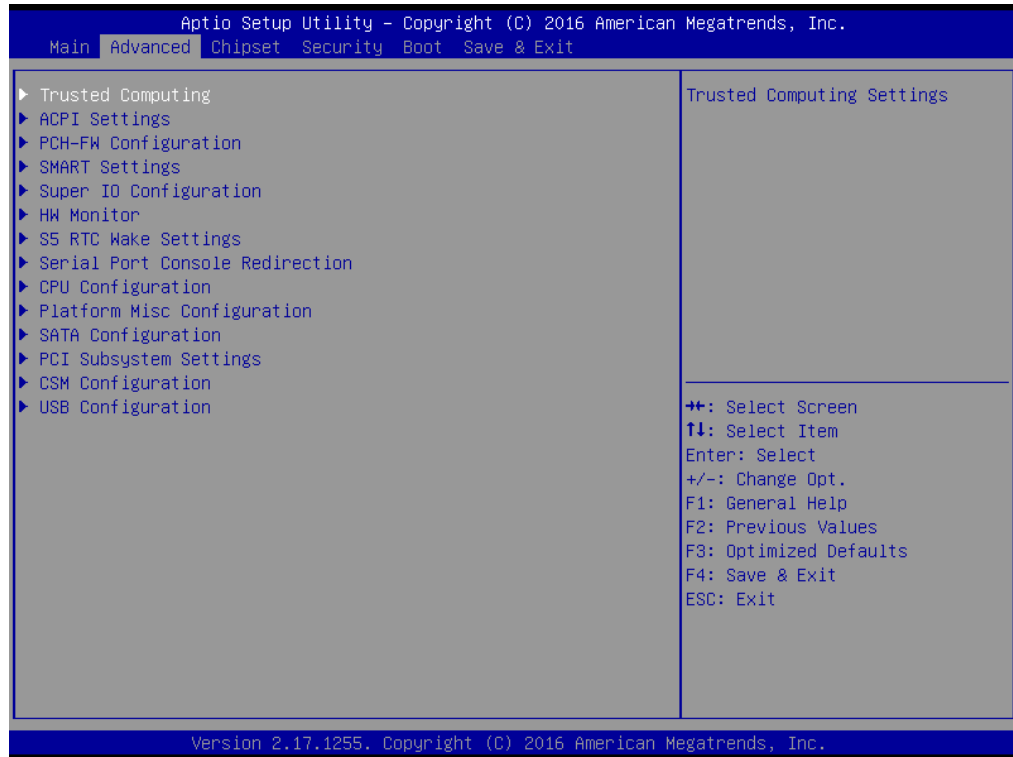

**Figure 3.3 Advanced BIOS features setup screen**



### 3.2.2.1 Trust Computing

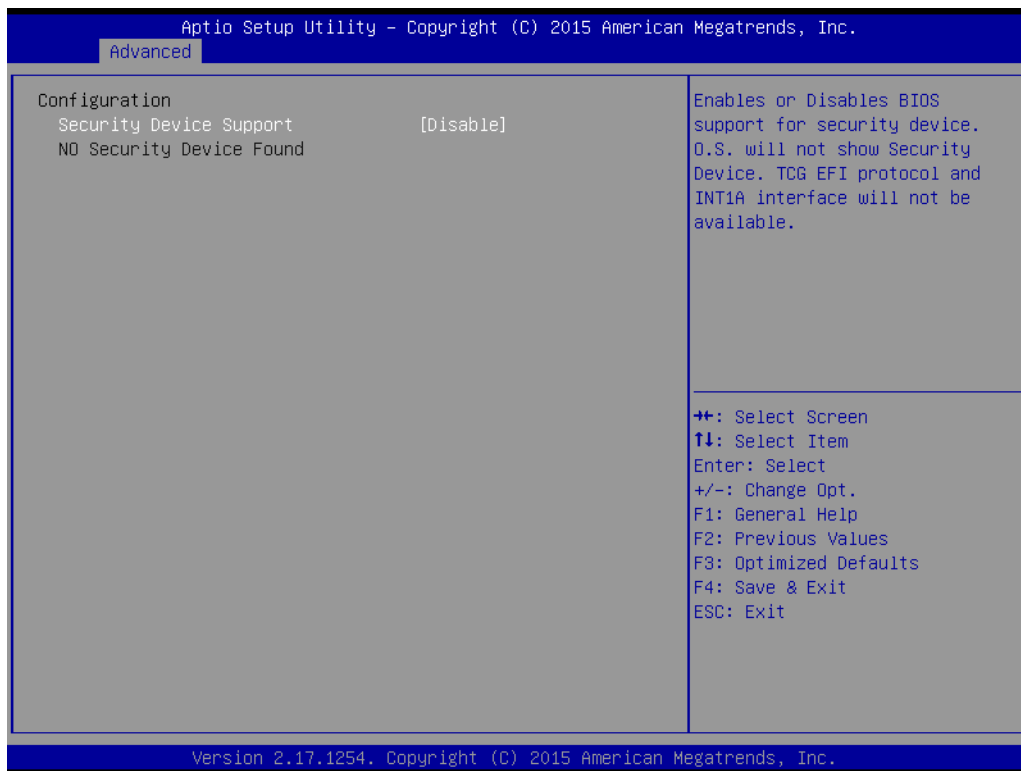

**Figure 3.4 Trust Computing**

- **Security Device Support**

Enable or disable BIOS for security device support. You can purchase Advantech TPM (Trust Platform Module) PCA-TPM-00A1E for your security device.

**Note!** *TCG EFI protocol and INT1A interface will not be available.*



### 3.2.2.2 ACPI Settings

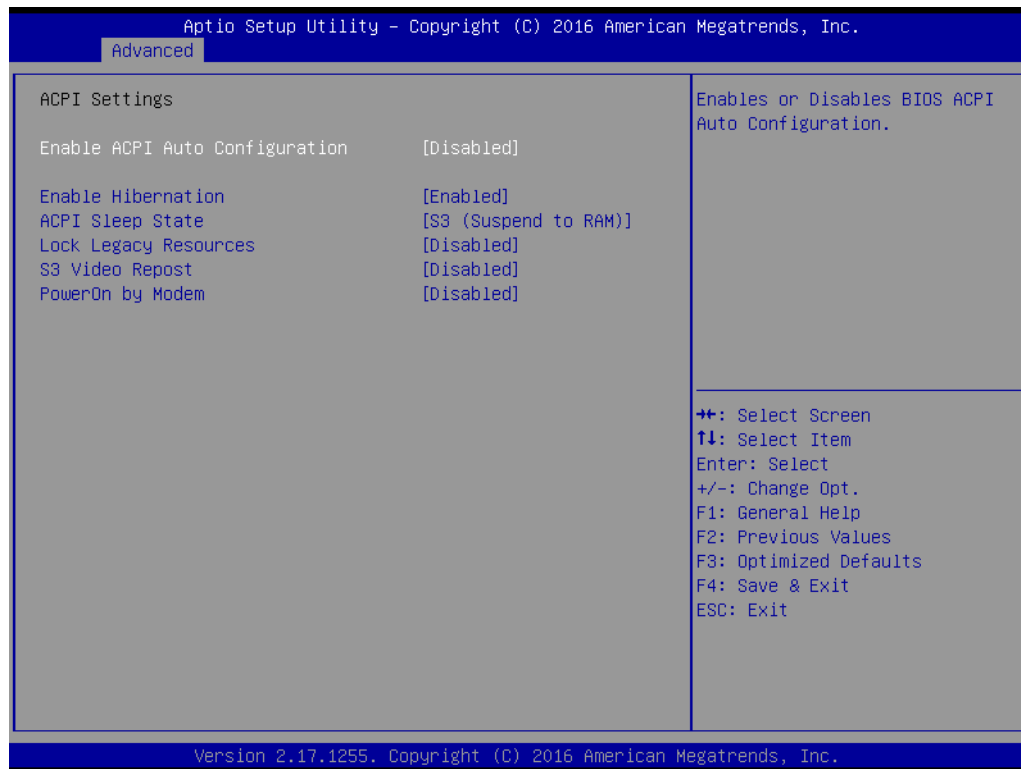

Figure 3.5 ACPI Settings

- **Enable ACPI Auto Configuration**  
Enable or disable BIOS ACPI Auto Configuration
- **Enable Hibernation**  
"Enable or disable" Hibernate (OS/S4 Sleep State). This option may not be effective with some OS.
- **ACPI Sleep State**  
Select S3 or disable suspend.
- **Lock Legacy Resources**  
Enables or disables Lock Legacy Resources.
- **S3 Video Repost**  
"Enable or Disable" S3 Video Repost.
- **PowerOn by Modem**  
"Enabled" or "Disabled" PowerOn by Modem

### 3.2.2.3 AMT Configuration

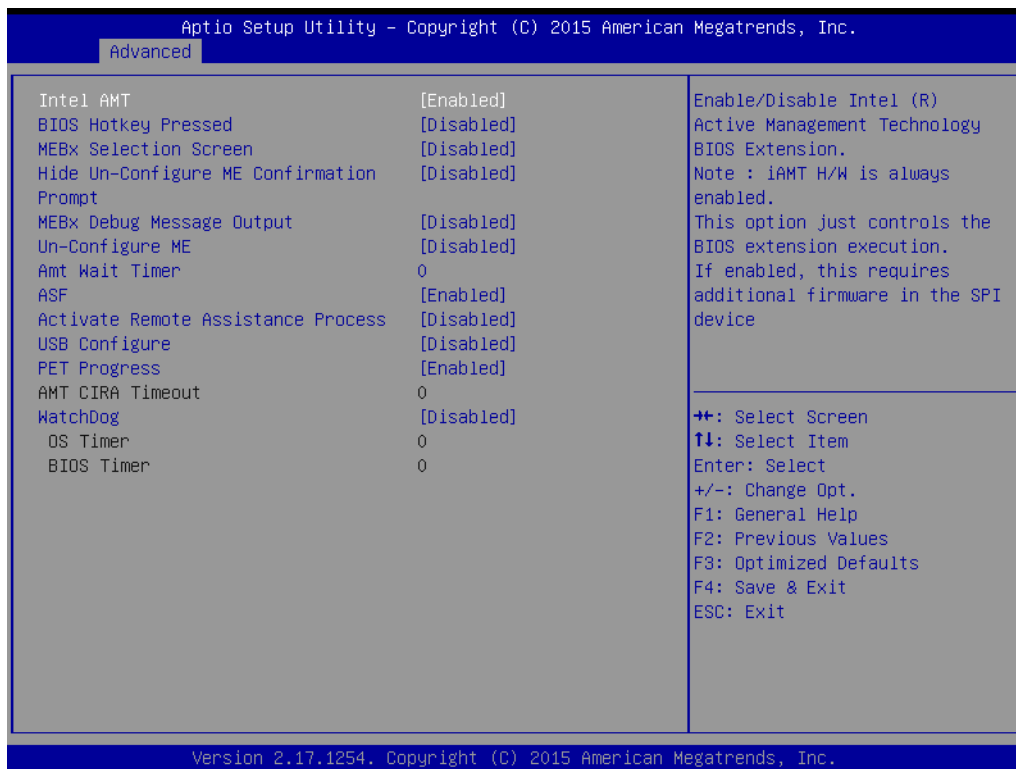

Figure 3.6 PCE-4129 AMT Configuration

- **Intel AMT**

Enable/Disable Intel Active Management Technology.

**Note!** *iAMT H/W is always enabled. This option controls the BIOS extension execution. If enabled, this requests additional firmware in the SPI device.*



*PCE-3029 series product dont support Intel AMT function.*

- **BIOS Hotkey Pressed**

Enable/Disable BIOS hotkey press.

- **MEBx Selection Screen**

Enable/Disable MEBx selection screen.

- **Hide Un-Configure ME Confirmation**

Hide un-configured ME without password confirmation prompt.

- **MEBx Debug Message Output**

Enable MEBx debug message output.

- **Un-Configure ME**

Un-configure ME without password.

- **Amt Wait Timer**

Set timer to wait before sending ASF\_GET\_Boot\_Options.

- **ASF**

Enable/Disable alert specification format.

- **Active Remote Assistance Process**

Trigger CIRA boot.

- **USB Configure**  
Enable/Disable USB configure function.
- **PET Progress**  
User can Enable/Disable PET events progress to receive PET events or note.
- **WatchDog**  
Enable/Disable Watchdog Timer

### 3.2.2.4 PCH-FW Configuration

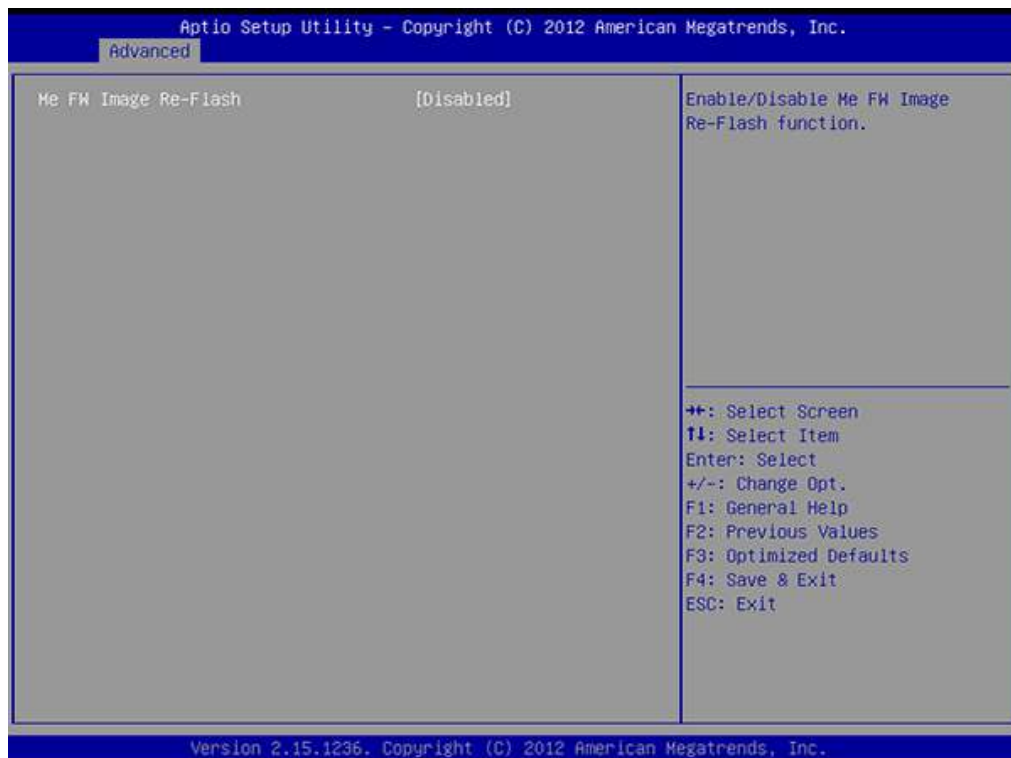
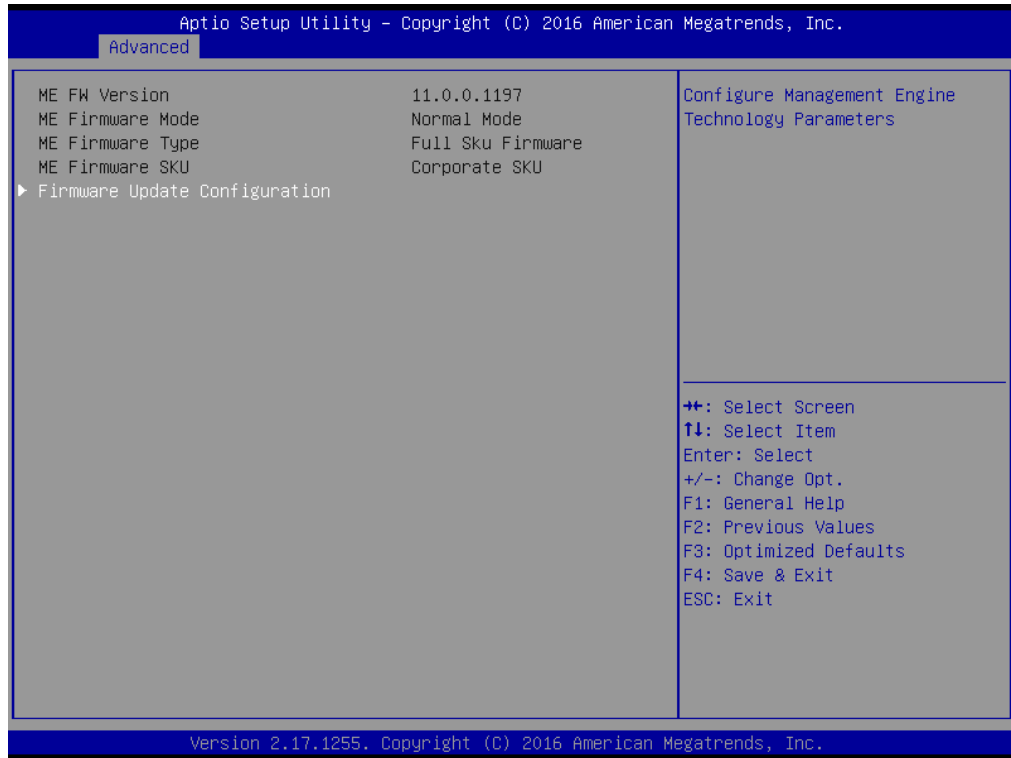

**Figure 3.7 Firmware Update Configuration**

- **ME FW Image Re-Flash**  
Enable/Disable ME FW Image Re-Flash function.

### 3.2.2.5 Smart Setting



**Figure 3.8 Smart Setting**

- **Smart self test**  
Run SMART self test on all HDDs during POST.

### 3.2.2.6 Super IO Configuration

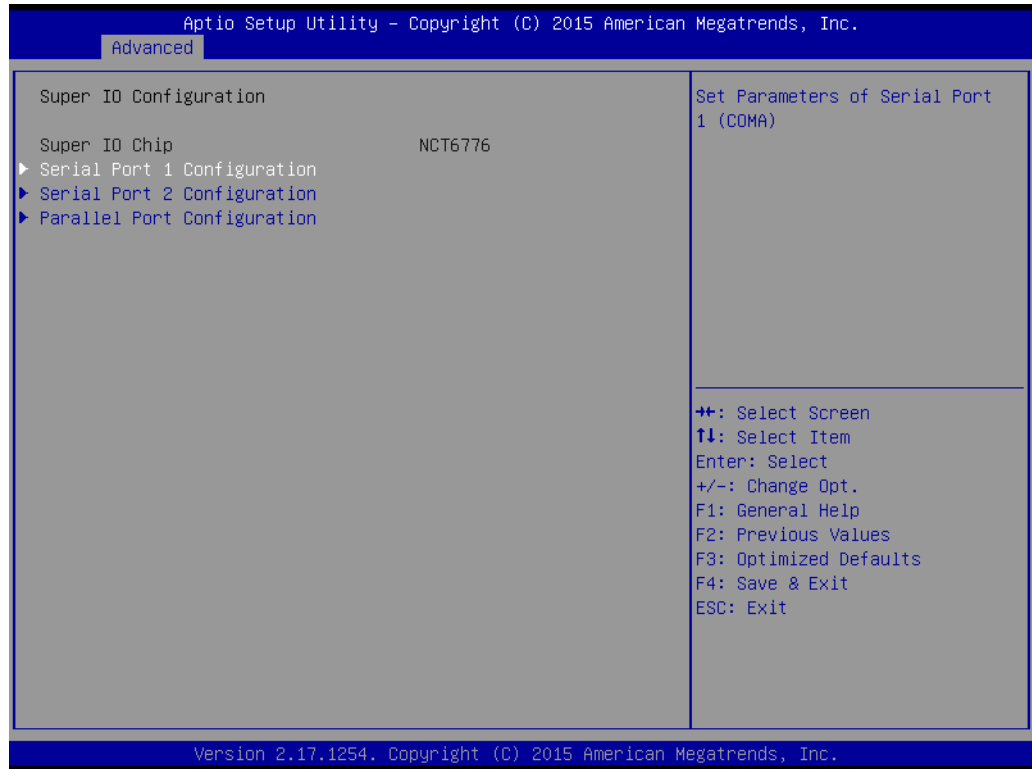

Figure 3.9 Super IO Configuration

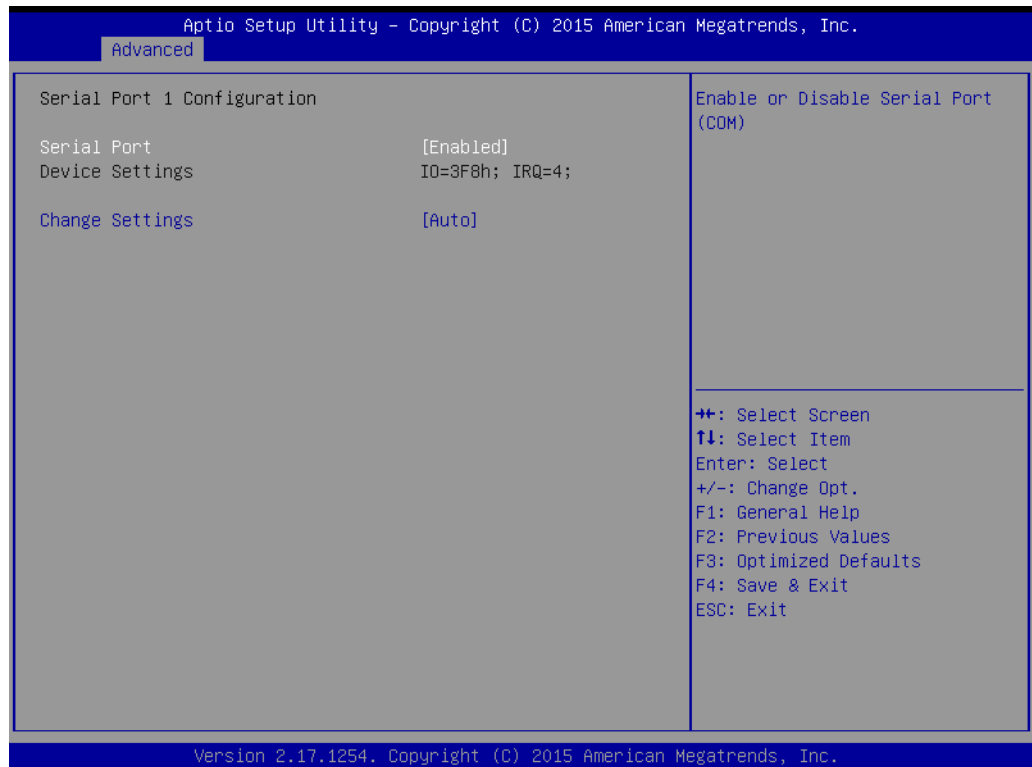

Figure 3.10 Serial Port 1 or 2 Configuration



**Figure 3.11 Parallel Configuration**

- **Serial Port 1 -2 configuration**  
"Enable or Disable" serial port
- **Parallel Port configuration**  
"Enable or Disable" parallel port

### 3.2.2.7 H/W Monitor

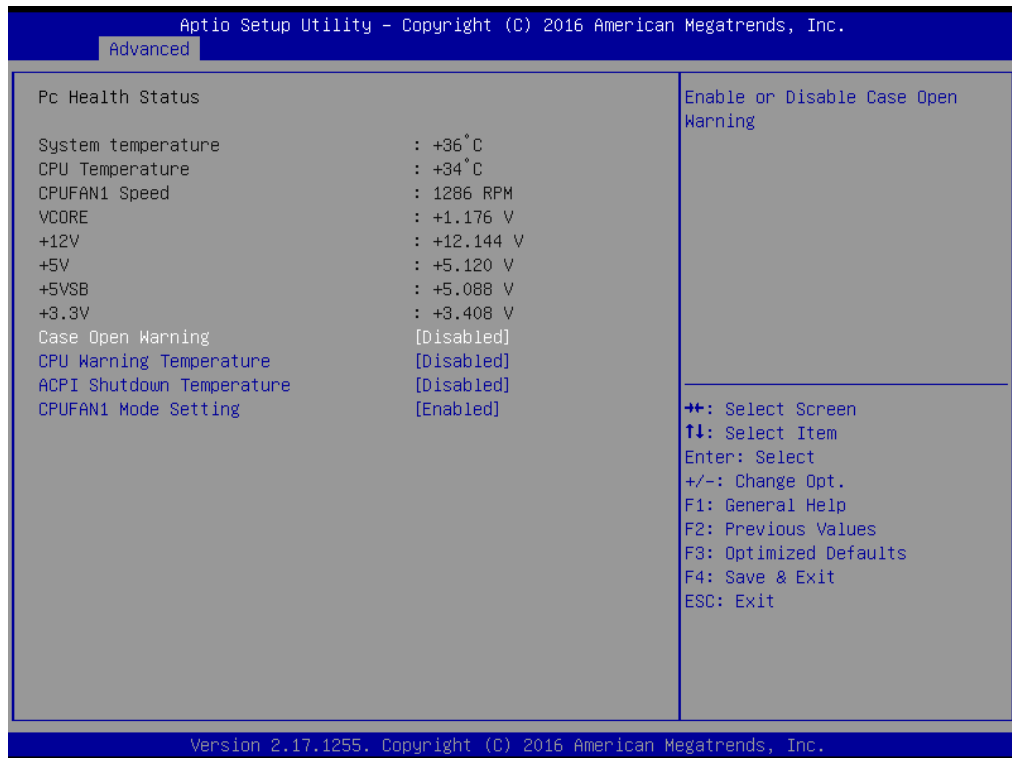
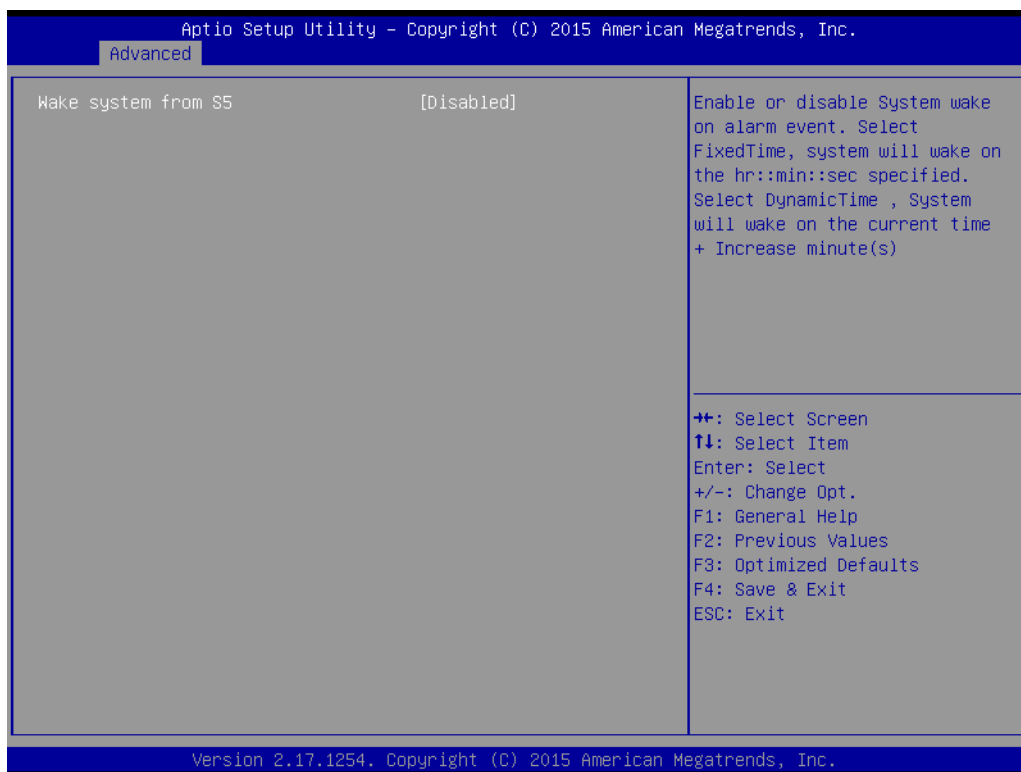

**Figure 3.12 PC Health Status**

- **Case Open Warning**  
Enable/Disable the chassis Intrusion monitoring function. When enabled and the case is opened, the speaker beeps.
- **CPU Warning Temperature**  
Use this to set the CPU warning temperature threshold. When the system reaches the warning temperature, the speaker will beep.
- **ACPI Shutdown Temperature**  
Use this to set the ACPI shutdown temperature threshold. When the system reaches the shutdown temperature, it will be automatically shut down by ACPI OS to protect the system from overheating damage.
- **CPUFAN1 Mode Setting**  
Enable/Disable Smart Fan.



### 3.2.2.8 S5 RTC Wake Setting



**Figure 3.13 S5 RTC configuration**

- **Wake System with Fixed Time**

Enable or disable system wake on alarm event. Select fixed time, system will wake on the hr:min:sec as specified. Select dynamic time, system will wake on the current time.

**Note!** "+" increase minute(s).



### 3.2.2.9 Serial Port console redirection

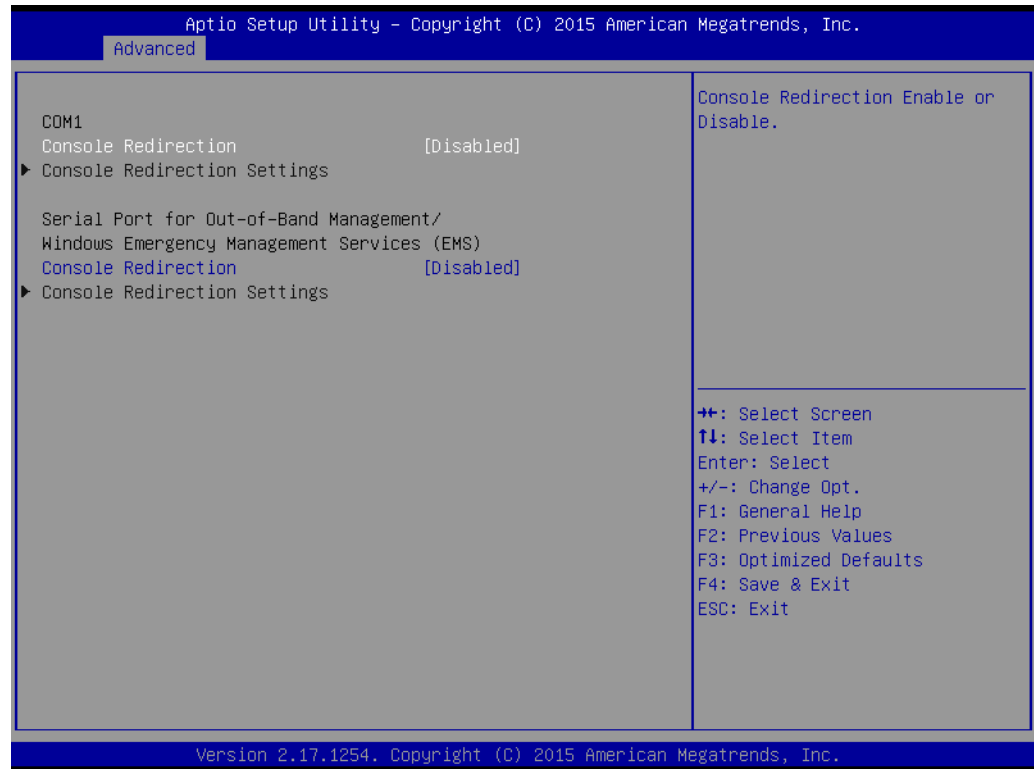

**Figure 3.14 Serial Port console redirection**

- **COM1**
  - **Console Redirection Settings**
    - Console Redirection Enable or Disable
- **Serial Port for Out-of-Band Management/ Windows Emergency Management services (EMS)**
  - **Console Redirection**
    - Console Redirection Enable or Disable

## 3.2.2.10 CPU Configuration

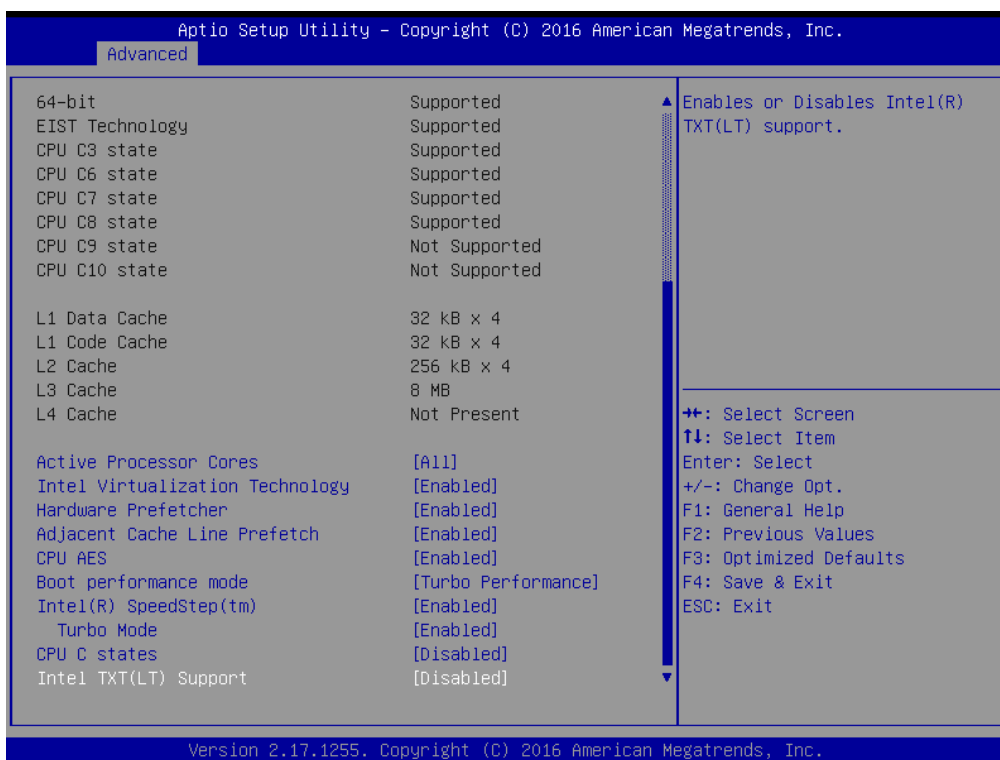
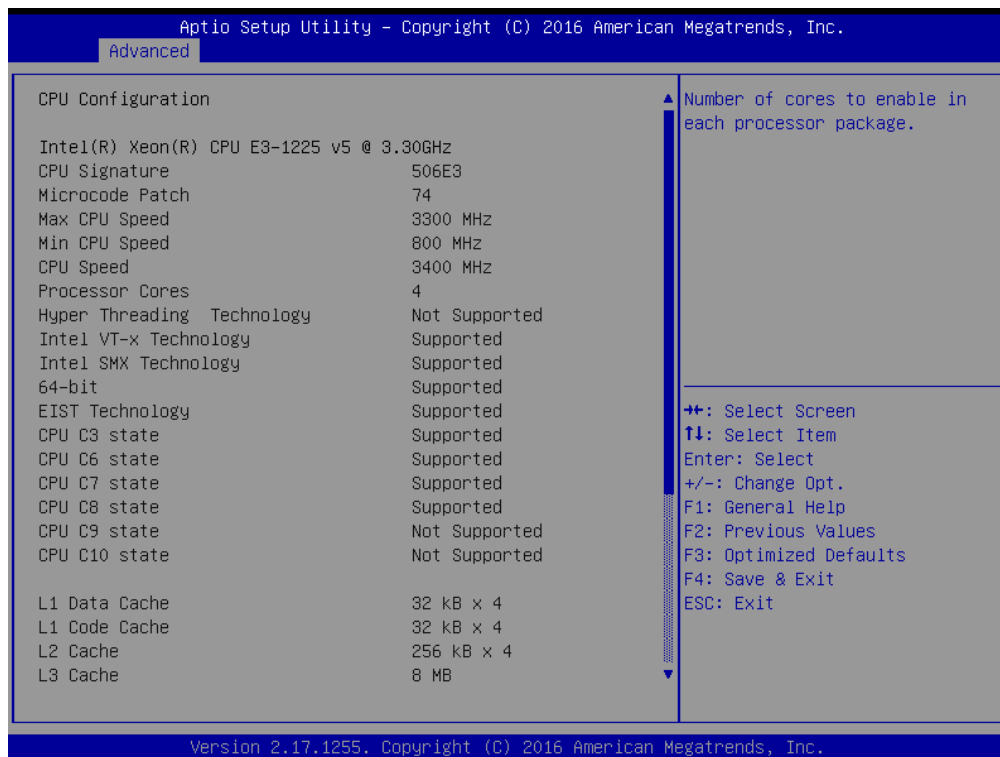

Figure 3.15 CPU Configuration

- 
- **Active Processor Core**  
Use this item to select the number of processor cores you want to activate when you are using a dual or quad core processor.
  - **Intel Virtualization Technology**  
This feature is used to "Enable or Disable" the Intel Virtualization Technology (IVT) extension. It allows multiple operating systems to run simultaneously on the same system by creating virtual machines, each running its own x86 operating system.
  - **Hardware Prefetcher**  
Hardware Prefetcher is a technique that fetches instructions and/or data from memory into the CPU cache memory well before the CPU needs it to improve the load-to-use latency. You may choose to "Enable or Disable" it.
  - **Adjacent Cache Line Prefetch**  
The Adjacent Cache-Line Prefetch mechanism, like automatic hardware prefetch, operates without programmer intervention. When it is enabled through the BIOS, two 64-byte cache lines are fetched into a 128-byte sector, regardless of whether the additional cache line has been requested or not. You may choose to "Enable or Disable" it.
  - **CPU AES**  
"Enable or Disable" CPA advanced encryption standard instruction.
  - **Boot Performance**  
Select the performance state that the BIOS will set before OS handoff.
  - **Intel(R) Speedstep(tm)**  
Allows more than two frequency ranges to be supported.
  - **CPU C states**  
Intel C states setting for power saving.
  - **Intel TXT(LT) Support**  
Enable or Disable Intel TXT support.

### 3.2.2.11 Platform Misc Configuration



**Figure 3.16 Platform Misc Configuration**

- **Native PCIE Enable**  
PCI Express Native Support Enable/Disable. This is only available in Vista.
- **Native ASPM**  
On enable, Vista will control the ASPM support for the device. If disabled, the BIOS will.

### 3.2.2.12 SATA Configuration

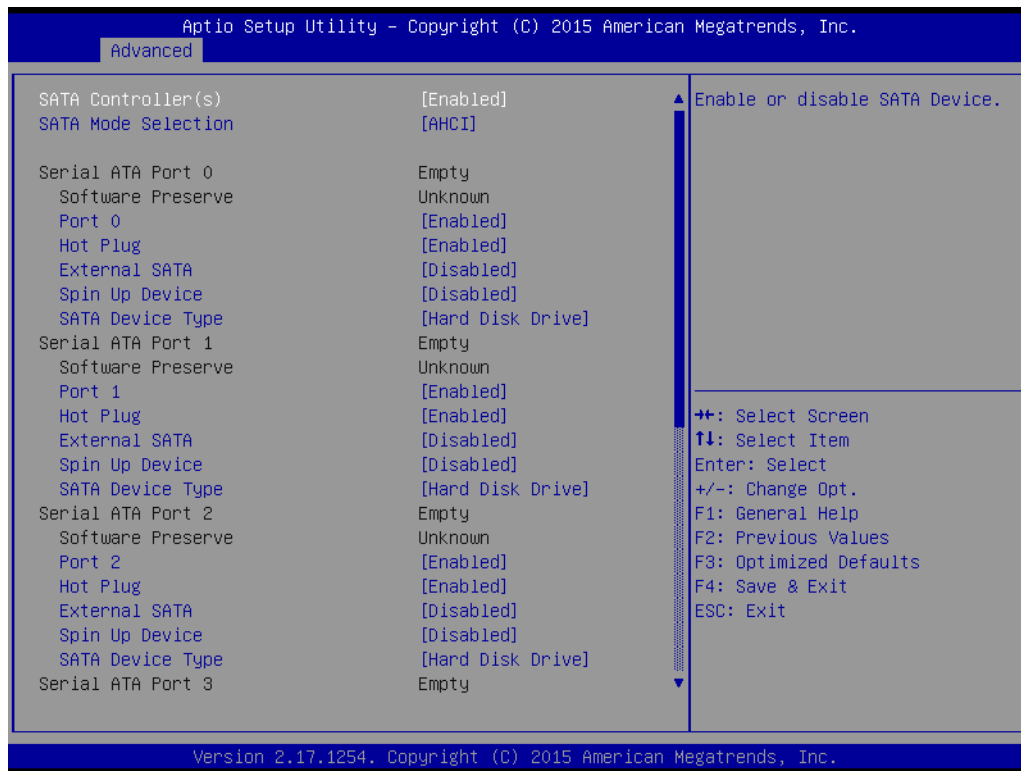
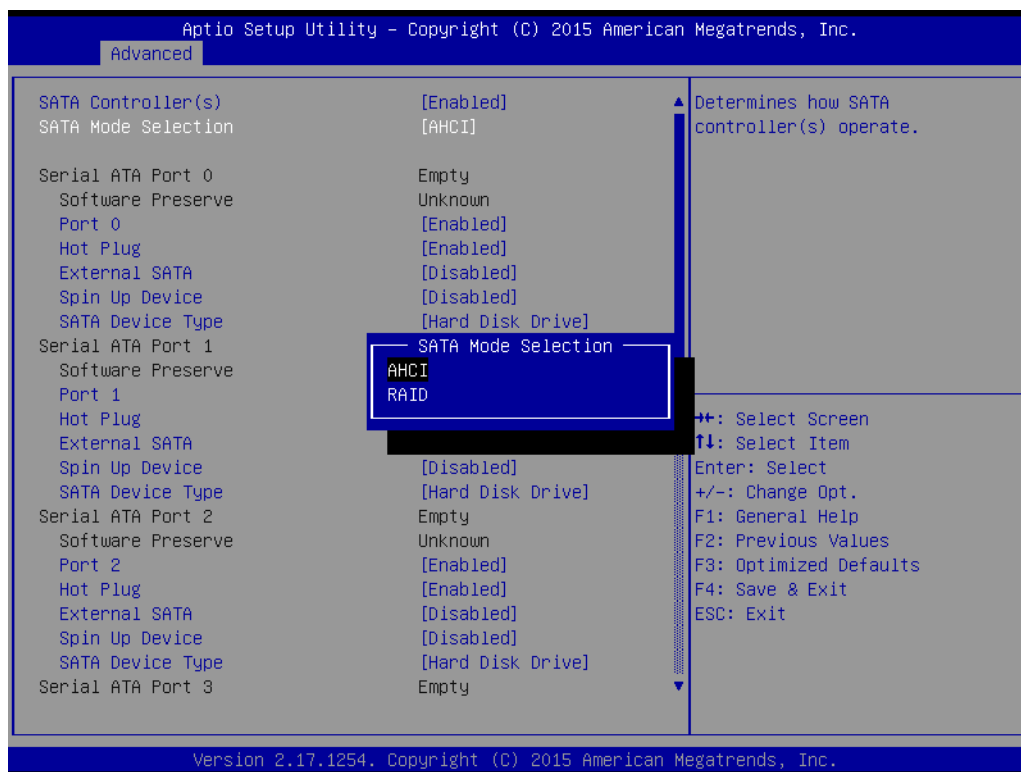

Figure 3.17 SATA Configuration

- **SATA Controller(s)**  
Enable or disable SATA Device
- **SATA Mode**  
This can be configured as AHCI and RAID



- **Port 0~5**  
To enable or disable SATA port 0~5.
- **Hot Plug**  
Enable/Disable SATA Hot-Plug
- **Spin up Device**  
Enable/disable spin up device
- **Port 0~5 Device Type**  
To identify the SATA that is connected to a Solid State or Hard Disk Drive.

### 3.2.2.13 PCI Subsystem Settings

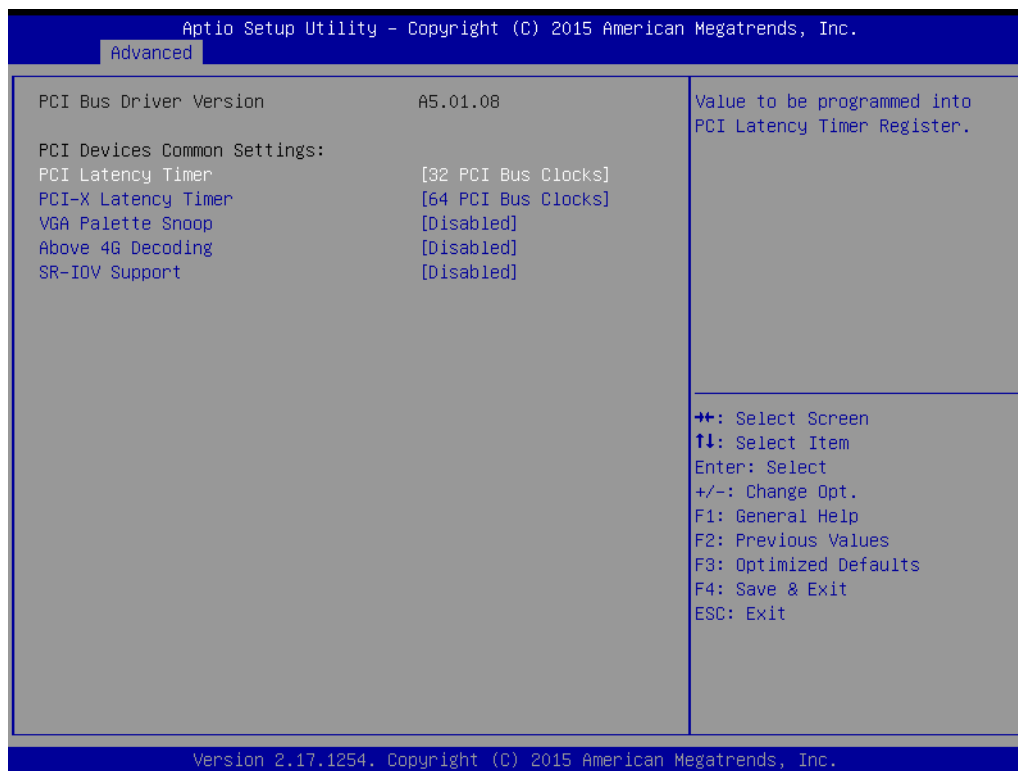

**Figure 3.18 PCI Subsystem Settings**

- **PCI Common Settings**
- **PCI Latency Timer**  
Value to be programmed into PCI Latency Timer Register.
- **PCI-X Latency Timer**  
Value to be programmed into PCI-X latency Timer Register.
- **VGA Palette Snoop**  
Enables/Disables VGA palette registers snooping.
- **Above 4G Decoding**  
Enable / disable above 4G decoding
- **SR-IOV Support**  
Enable / disable SR-IOV Support

### 3.2.2.14 CSM Configuration

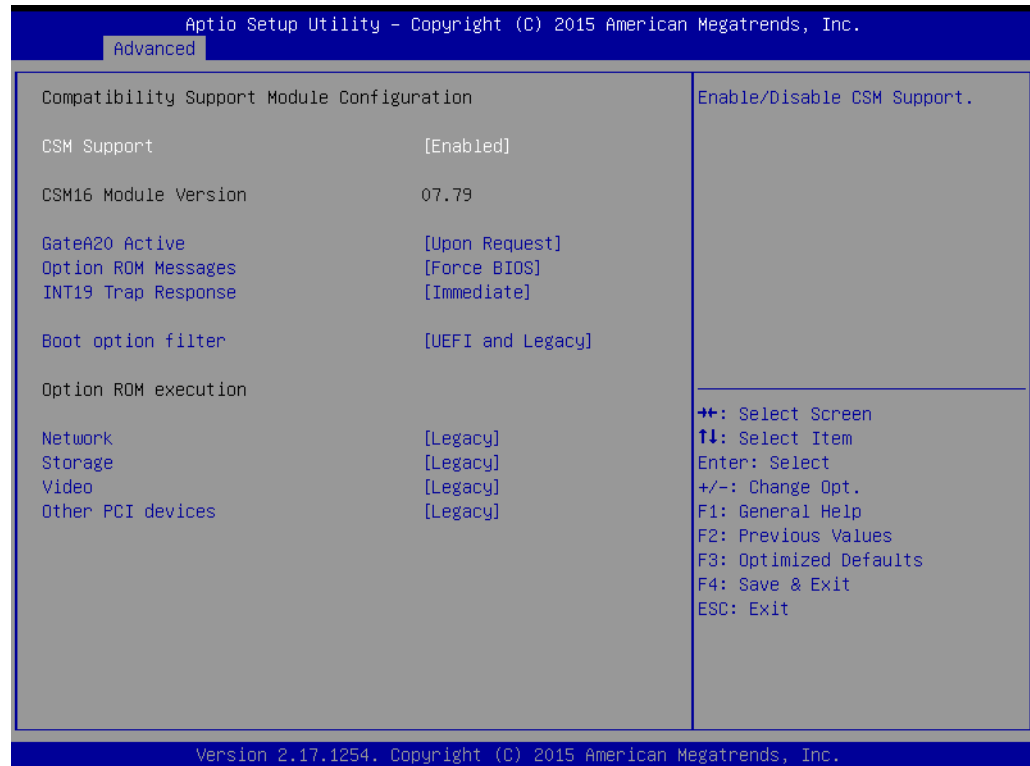
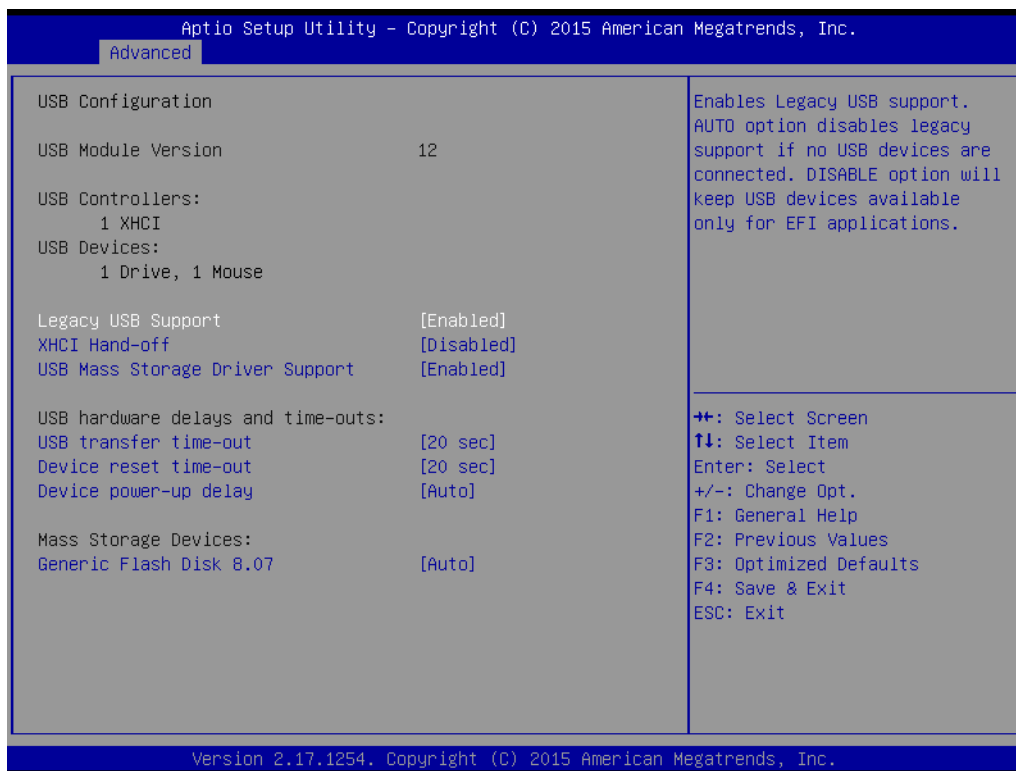

Figure 3.19 PCI Express Settings

- **Compatibility Support Module Configuration**
  - **CSM Support**  
Enable/Disable CSM Support.
- **CSM16 Module Version**
  - **GateA20 Active**  
Upon Request - GA20 can be disabled using BIOS services. Always - do not allow disabling GA20; this option is useful when any RT code is executed above 1MB.
  - **Option ROM Message**  
Set display mode for Option ROM.
  - **INT19 Trap Response**  
BIOS reaction on INT19 trapping by Option ROM: Immediate - execute the trap right away; Postponed - execute the trap during legacy boot.
  - **Boot option filter**  
This option controls Legacy/UEFI ROMs Priority.
- **Option ROM execution**
  - **Network**  
Controls the execution of UEFI and Legacy PXE OpROM.
  - **Storage**  
Controls the execution of UEFI and Legacy Storage OpROM.
  - **Video**  
Controls the execution of UEFI and Legacy Video OpROM.
  - **Other PCI devices**  
Determines OpROM execution policy for devices other than Network, Storage, or Video.



### 3.2.2.15 USB Configuration



**Figure 3.20 USB Configuration**

- **Legacy USB Support**  
This is for USB device support under legacy OS such as DOS. When choosing "AUTO", the system will automatically detect if any USB device is plugged into the computer and enable USB legacy mode when a USB device is plugged in, and disable USB legacy mode when no USB device is plugged in.
- **XHCI Hand-off**  
This is a workaround for OS without XHCI hand-off support. The XHCI ownership change should be claimed by XHCI driver.
- **USB Mass Storage Driver Support**  
Enable/Disable USB Mass Storage Driver Support.
- **USB transfer time-out**  
Allows you to select the USB transfer time-out value. [1,5,10,20sec].
- **Device reset time-out**  
Allows you to select the USB device reset time-out value. [1,5,10,20sec].
- **Device power-up delay**  
This item appears only when you set device power-up delay item to [manual].
- **Mass Storage Devices**

## 3.2.3 Chipset



Figure 3.21 Chipset

### 3.2.3.1 System Agent (SA) Configuration

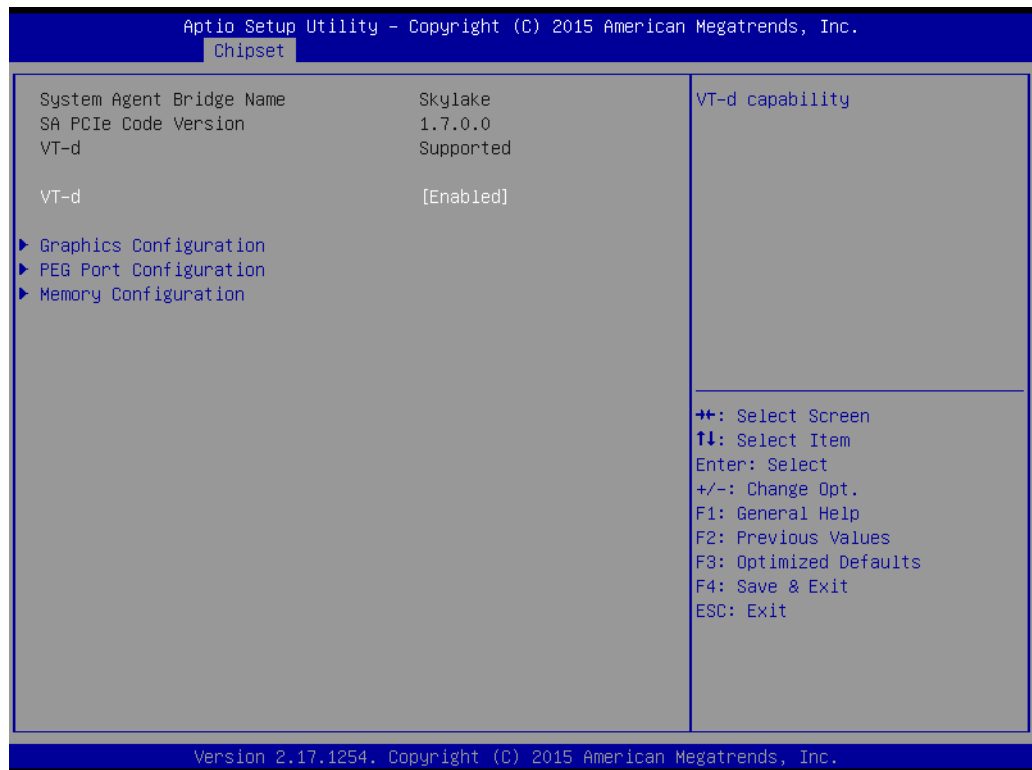
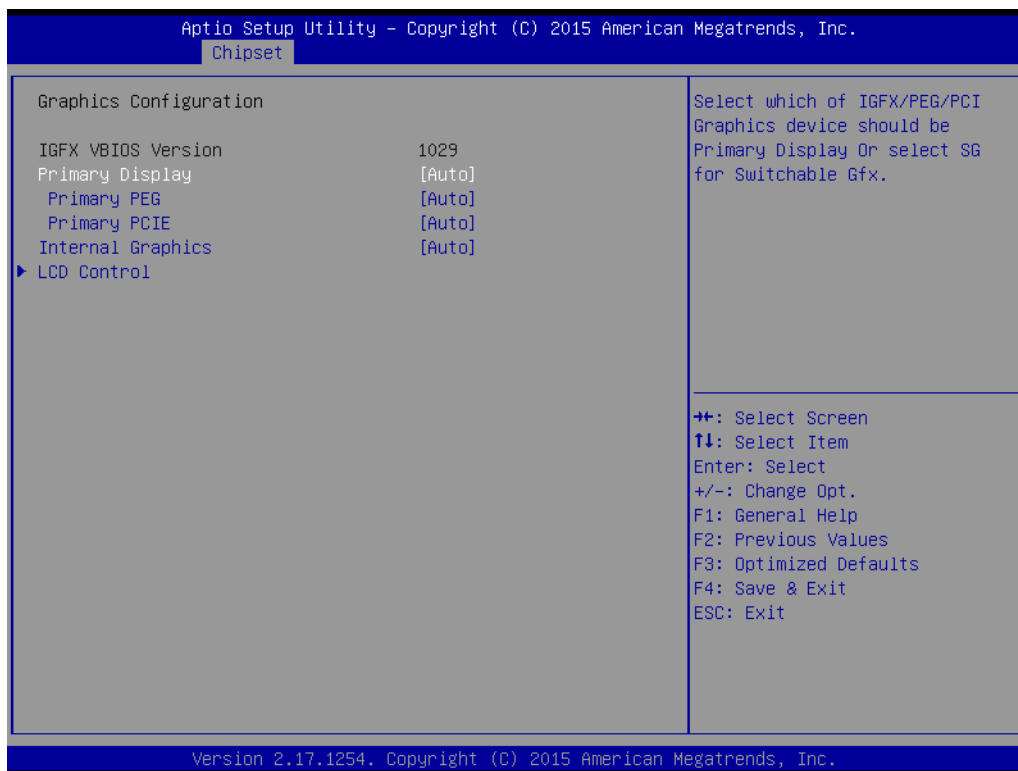

Figure 3.22 System Agent (SA) Configuration

- **VT-d**  
Check to enable VT-d function on MCH.

### 3.2.3.2 Graphics Configuration



- **Primary Display**  
Select which IGFX/PEG/PCI graphics device should be primary display or select SG for switchable GFX.
- **Primary PEG**  
Select PEG0/PEG1/PEG2/PEG3 graphics device should be Primary PEG.
- **Primary PCIE**  
Select Auto/ PCIE1/ PCIE2/ PCIE3/ PCIE4/ PCIE5/ PCIE6/ PCIE7 of D28: F0/ F1/ F2/ F3/ F4/ F5/ F6/ F7, PCIE8/PCIE9/PCIE10/PCIE11/PCIE12/PCIE13/ PCIE14/PCIE15 of D29: F0/ F1/ F2/ F3/ F4/ F5/ F6/ F7/, PCIE16/ PCIE17/ PCIE18/ PCIE19 of D27: F0/ F1/ F2/ F3, Graphics device should be primary PCIE.
- **Internal Graphics**  
Keep IGD enabled based on the setup options.

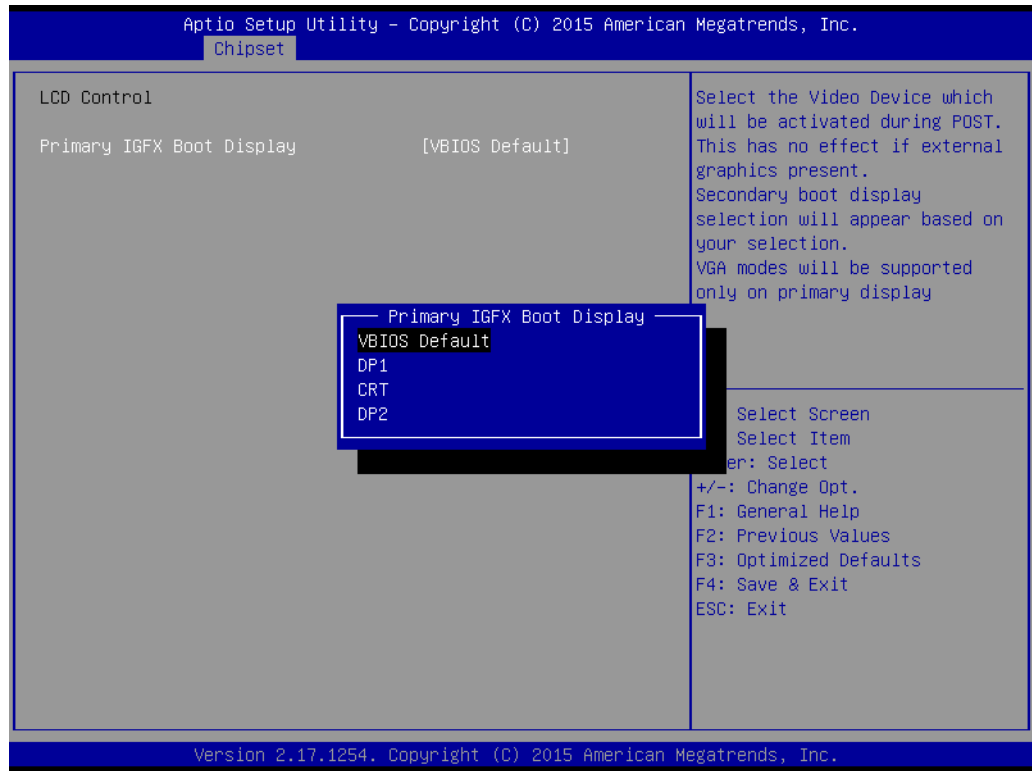

**Figure 3.23 Graphics Configuration**

- **LCD Control**  
Select Primary IGFX Boot Display (VBIOS Default, DP1, CRT, DP2).

### 3.2.3.3 PEG Port Configuration

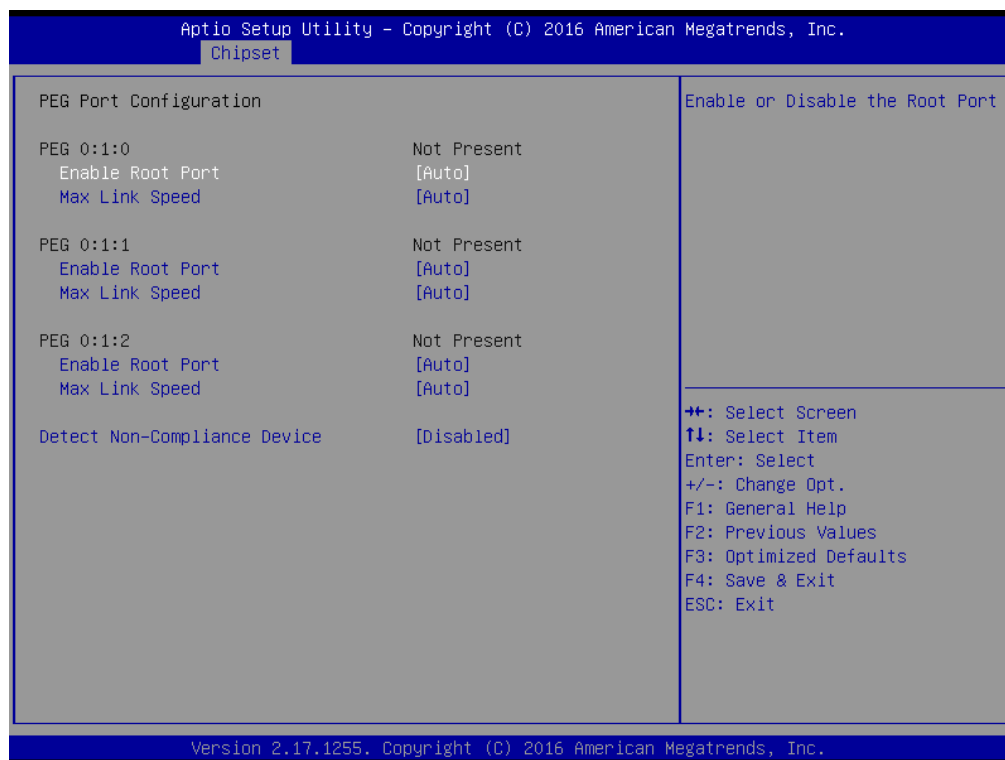

**Figure 3.24 PEG Port Configuration**

- **Enable Root Port**  
Enable or disable the root port
- **Max Link speed**  
Configure PEG 0:1:0 max speed
- **Detect Non-compliance device**  
Detect Non-Compliance PCI express Device in PEG

### 3.2.3.4 Memory Configuration

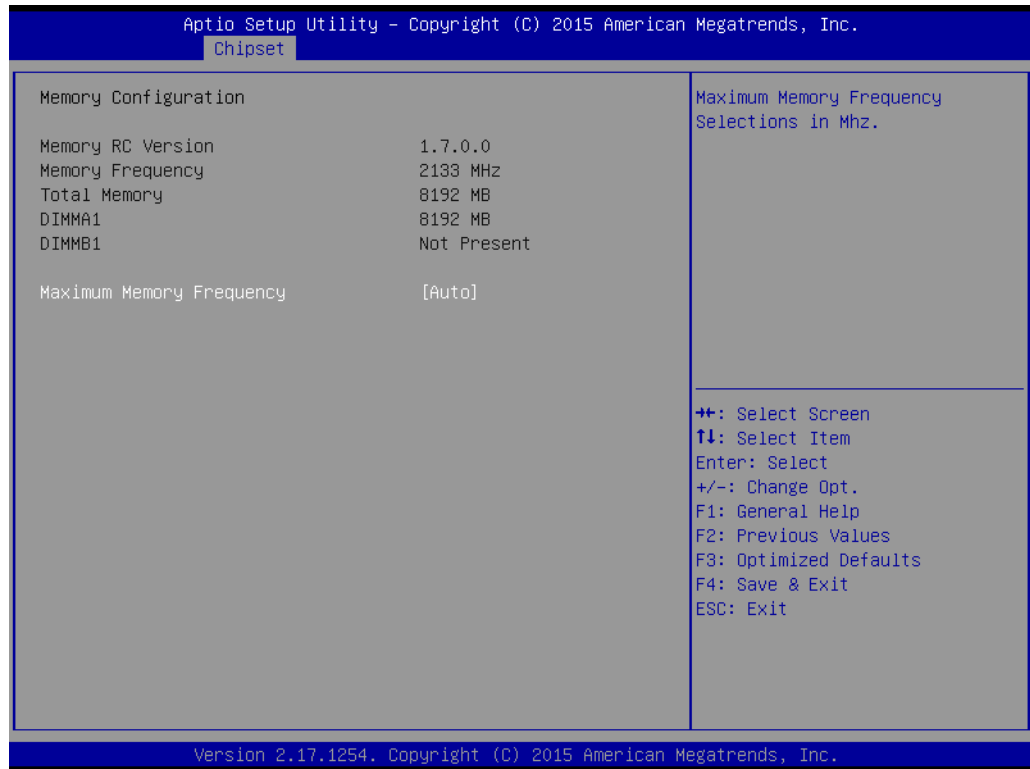

Figure 3.25 Memory Information

- Maximum Memory Frequency**  
 Maximum memory frequency selections in Mhz.

### 3.2.3.5 PCH-IO Configuration

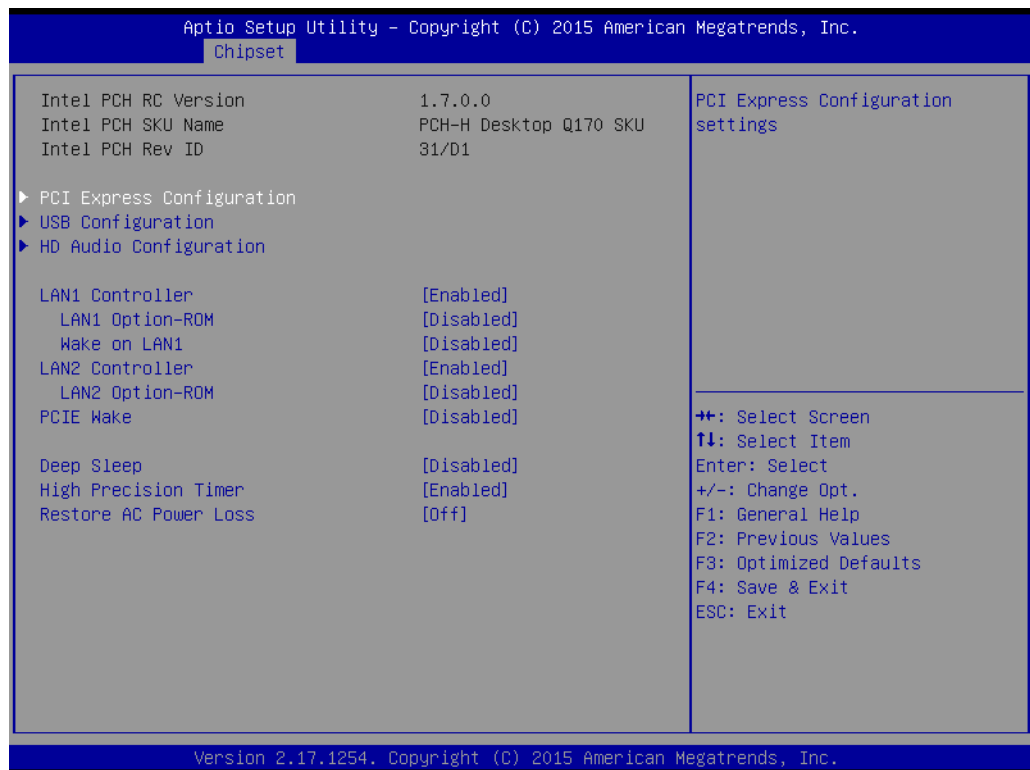
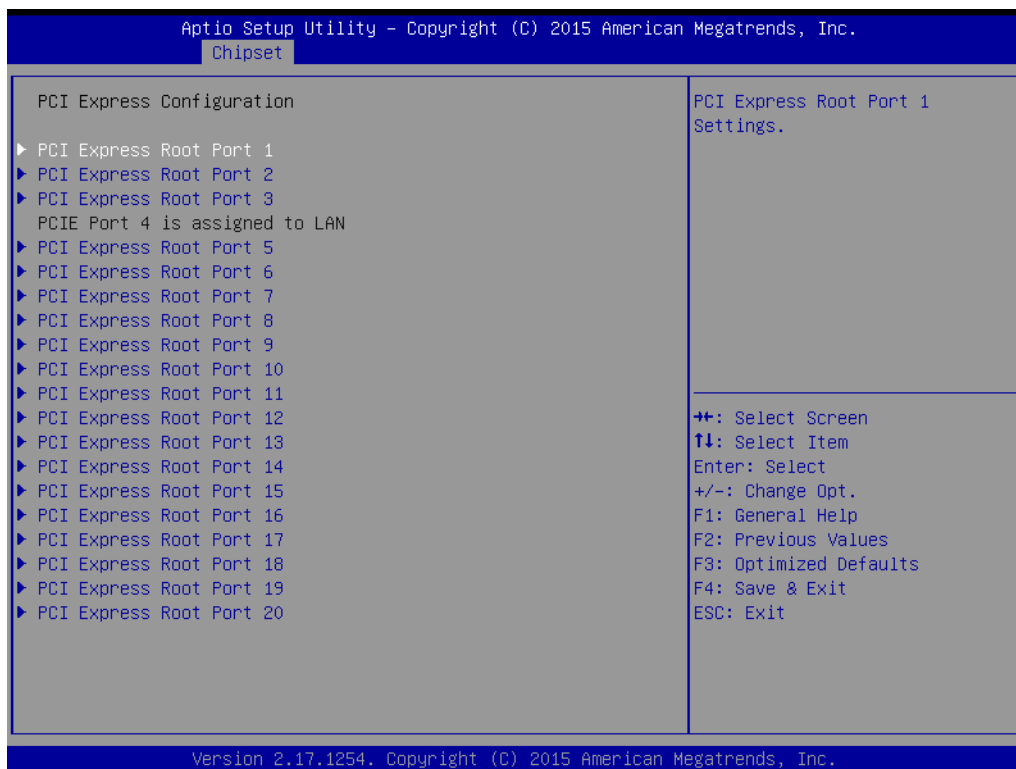

Figure 3.26 PCH IO Configuration

- **LAN1 Controller**  
Enable or Disable LAN1 controller.
- **LAN 1 Option-ROM**  
Enable or Disable LAN 1 boot option for legacy network devices.
- **Wake on LAN1 from S5**  
Enable or Disable LAN1 to wake the system. (The wake on LAN cannot be disabled if ME is on at Sx state).
- **LAN2 Controller**  
Enable or Disable LAN2 controller.
- **LAN 2 Option-ROM**  
Enable or Disable LAN 2 boot option for legacy network devices.
- **PCIE Wake**  
Enable or Disable PCIE to wake the system from S5.
- **High Precision Timer**
- **Restore AC Power Loss**  
Power Off, Power On or last state to restore AC power loss.

### 3.2.3.6 PCI Express Configuration



**Figure 3.27 PCI Express Configuration**

- **PCI Express Root Port 1~20 status**

### 3.2.3.7 USB Configuration

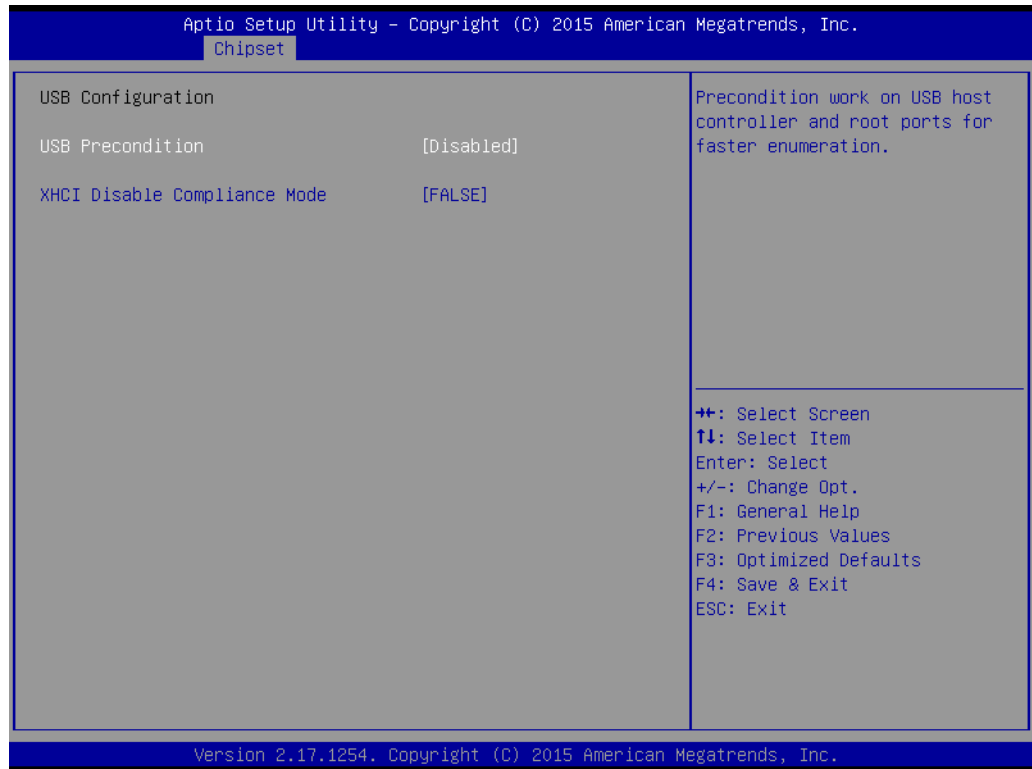

**Figure 3.28 USB Configuration**

- **USB Precondition**  
Pre-condition work on USB host controller and root ports for faster enumeration.
- **XHCI Mode**  
Select Smart auto, Auto, Enable, and Disable mode of operation of XHCI controller.

**Note!** *Smart auto setting remembers last setting, but auto mode does not.*





### 3.2.3.8 HD Audio Configuration



**Figure 3.29 PCH Azalia Configuration**

- **HD Audio**

Control detection of the HD Audio device.

Disable=HDA will be unconditionally disabled.

Enable=HDA will be unconditionally enabled.

Auto=HDA will be enabled if present, disabled otherwise.

## 3.2.4 Security

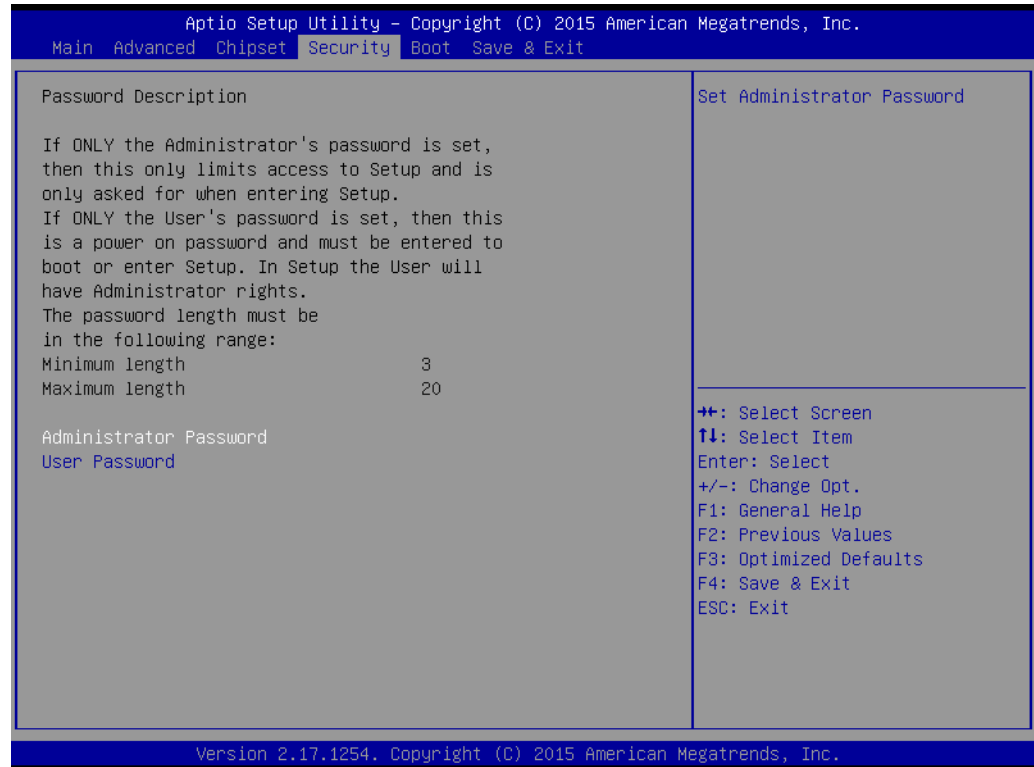

**Figure 3.30 Security**

Select Security Setup from the PCE-3029/4129 setup main BIOS setup menu. All Security Setup options, such as password protection and virus protection are described in this section. To access the sub menu for the following items, select the item and press <Enter>.

## 3.2.5 Boot



**Figure 3.31 Boot**

- **Setup Prompt timeout**  
Number of seconds to wait for setup activation key.
- **Bootup NumLock State**  
Select the keyboard Numlock state.
- **Quiet Boot**  
Enable/Disable Quiet Boot option.
- **Boot Option Priorities**  
Displays information about boot priority options of devices.
- **Hard Drive BBS Priorities**  
Set the order of the legacy devices in this group.

## 3.2.6 Save & Exit

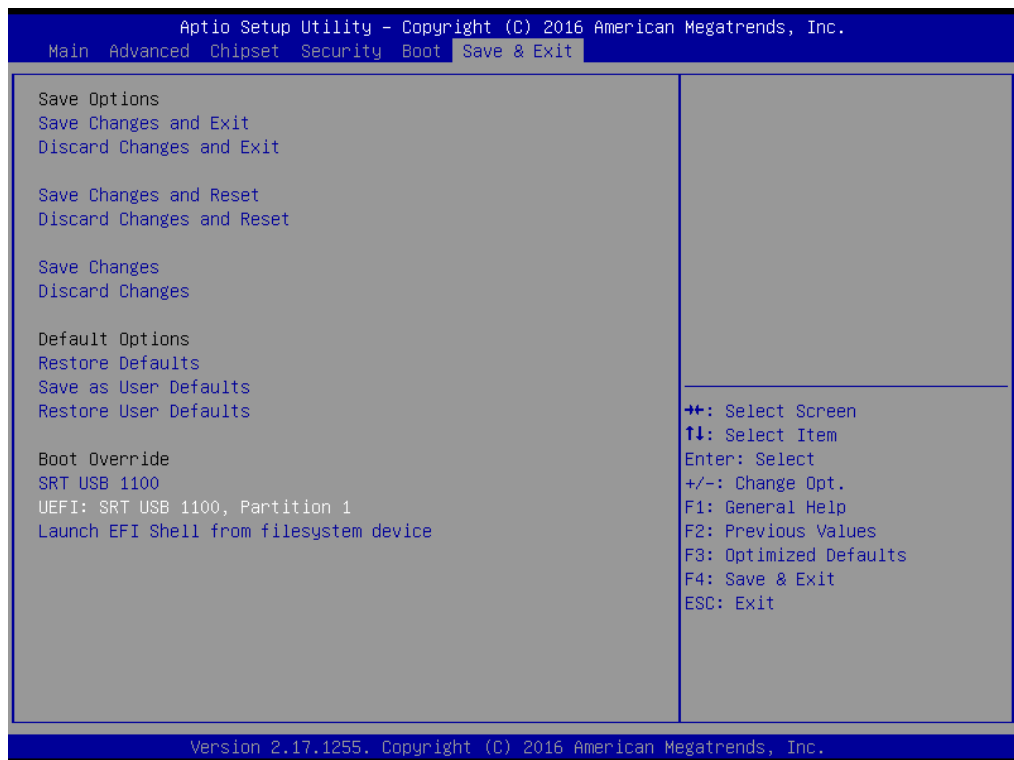

Figure 3.32 Save & Exit

- **Save changes and exit\***  
When you have completed system configuration, select this option to save your changes.
- **Discard changes and exit**  
Select this option to quit Setup without making any permanent changes to the system configuration.
- **Save changes and Reset**  
When you have completed system configuration, select this option to save your changes, exit BIOS setup and reboot into the computer so the new system configuration parameters can take effect.
- **Discard changes and Reset**  
Select this option to quit setup and reset computer without making any permanent changes to the system configuration.
- **Save Changes**  
Select this option to save your changes.
- **Discard Changes**  
Select this option to discard your changes.
- **Restore Defaults**  
Select this option to restore BIOS configuration as origin.
- **Save as User Defaults**  
Select this option to save user's configuration.
- **Restore User Defaults**  
Select this option to restore BIOS to user's configuration.

\*When you make some critical changes, the system will still reboot even if you chose "Save changes and exit".

# Chapter 4

## Value-Added Software Services

## 4.1 Value-Added Software Services

Software API are interface that define the ways in which an application program may request services from libraries and/or operating systems. They provide not only the underlying drivers required but also a rich set of user-friendly, intelligent and integrated interfaces, which speed development, enhance security and offer add-on value for Advantech platforms. APIs plays the role of catalyst between developer and solution, and make Advantech embedded platforms easier and simpler to adopt and operate with customer applications. This API and utility is only for XP (32/64 bit), Win7 (32/64bit), and Win8 (32/64bit), so if users needs Linux version API and utility, then contact an Advantech representative for support. For Windows systems, please install the .Net Framework v 3.5 in the driver CD.

### 4.1.1 Software API

#### 4.1.1.1 Control

##### GPIO



General Purpose Input/Output is a flexible parallel interface that allows a variety of custom connections. allows users to monitor the level of signal input or set the output status to switch on/off the device. Our API also provides Programmable GPIO, which allows developers to dynamically set the GPIO input or output status.

#### 4.1.1.2 Monitor

##### Watchdog



A watchdog timer (WDT) is a device that performs a specific operation after a certain period of time if something goes wrong and the system does not recover on its own. A watchdog timer can be programmed to perform a warm boot (restarting the system) after a certain number of seconds.

##### Hardware Monitor



The Hardware Monitor (HWM) API is a system health supervision API that inspects certain condition indexes, such as fan speed, temperature and voltage.

# Chapter 5

Chipset Software  
Installation Utility

## 5.1 Before You Begin

To facilitate the installation of the enhanced display drivers and utility software, read the instructions in this chapter carefully. The drivers for the PCE-3029/4129 are located on the software installation CD. The driver in the folder of the driver CD will guide and link you to the utilities and drivers for Windows. Updates are provided via Service Packs from Microsoft®.

**Note!** *The files on the software installation CD are compressed. Do not attempt to install the drivers by copying the files manually. You must use the supplied SETUP program to install the drivers.*



Before you begin, it is important to note that most display drivers need to have the relevant software application already installed in the system prior to installing the enhanced display drivers. In addition, many of the installation procedures assume that you are familiar with both the relevant software applications and operating system commands. Review the relevant operating system commands and the pertinent sections of your application software's user manual before performing the installation.

## 5.2 Introduction

The Intel® Chipset Software Installation (CSI) utility installs the Windows INF files that outline to the operating system how the chipset components will be configured. This is needed for the proper functioning of the following features:

- PCIe Support
- SATA Storage Support
- USB Support
- Identification of Intel(R) Chipset Components in device manager



## 5.3 Windows 7/8.1/10 Driver Setup

1. Insert the driver CD into your system's CD-ROM drive. You can see the driver folder items. Navigate to the "01\_Chipset" folder, choosing the operating system, and click "infinst\_autol.exe" to complete the installation of the driver.

**Note!** *Wrong driver installation may cause unexpected system instability.*





# Chapter 6

Integrated Graphic  
Device Setup

## 6.1 Introduction

6th generation Intel CPUs have integrated graphics controllers. You need to install the VGA driver to enable this function.

## 6.2 Windows 7/8.1/10 Driver Setup

**Note!** Before installing this driver, make sure the INF driver has been installed in your system. See Chapter 5 for information on installing the INF driver.



Insert the driver CD into your system's CD-ROM drive. You can see the driver folder items. Navigate to the "02\_Graphic" folder, choosing the operating system and click "setup.exe" to complete the installation of the driver.

**Note!** Wrong driver installation may cause unexpected system instability.

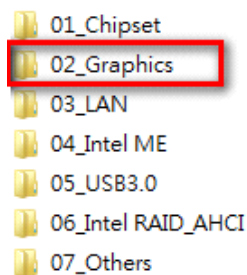

# Chapter 7

## LAN Configuration

## 7.1 Introduction

PCE-3029/4129 has dual Gigabit Ethernet LANs via dedicated PCI Express x1 lanes (For PCE-3029, LAN1 is Intel I219V, and LAN2 is I211AT; for PCE-4129, LAN1 is Intel I219LM, and LAN2 is I210AT) that offer bandwidth of up to 500 MB/sec, eliminating network data flow bottlenecks and incorporating Gigabit Ethernet at 1000 Mbps.

## 7.2 Installation

**Note!** *Before installing the LAN drivers, make sure the CSI utility has been installed on your system. See Chapter 5 for information on installing the CSI utility.*



PCE-3029/4129 Gigabit integrated controllers support all major network operating systems. However, the installation procedure varies from system to system. Please find and use the section that provides the driver setup procedure for the operating system you are using.

## 7.3 Windows 7/8.1/10 Driver Setup (LAN)

Insert the driver CD into your system's CD-ROM drive. Navigate to the "03\_LAN" folder and click "Autorun.exe" to complete the installation of the driver.

**Note!** *Wrong driver installation may cause unexpected system instability.*



# Chapter 8

Intel ME

## 8.1 Introduction

The Intel® ME software components that need to be installed depend on the system's specific hardware and firmware features. The installer detects the system's capabilities and installs the relevant drivers and applications.

## 8.2 Installation

Insert the driver CD into your system's CD-ROM drive. Navigate to the "04\_Intel ME" folder to complete the installation of the driver.

**Note!** *If the Intel® Management Engine (Intel® ME) driver has not been successfully installed, you may see an error on a "PCI Simple Communications Controller" in Device Manager.*

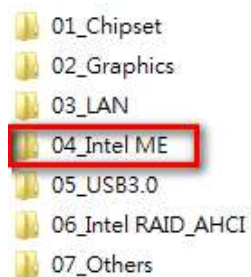



# Chapter 9

Intel USB 3.0

## 9.1 Introduction

PCE-3029/4129 provides Intel® USB 3.0 and the data transfer rates of USB 3.0 (5 Gbps) which is 10 times faster than USB 2.0 (480Mbps).

## 9.2 Installation

Insert the driver CD into your system's CD-ROM drive. Navigate to the "05\_USB3.0" folder and click "setup.exe" to complete the installation of the driver.

**Note!**



- *Since Intel® 6th generation PCH only features USB 3.0 Host Controller and Microsoft Windows 7 excludes USB3.0 in box driver, USB device might not work properly while installing Windows 7. Please use SATA device to install Windows 7 and USB3.0 driver.*
- *Advantech embedded WES7 image preload USB3.0 driver.*
- *Since Windows 8.1 and 10 have in box USB3.0 driver, USB3.0 host controller can be activated while installing OS.*
- *Intel only supports USB3.0 driver for Windows 7.*



# Chapter 10

## SATA RAID Setup

## 10.1 Introduction

To support demanding disk I/O, PCE-4129 with Intel chipset integrates Serial ATA controllers with software RAID 0, 1, 5, 10 capabilities.

RAID 0 striping increases the storage performance and is designed to speed up data transfer rates for disk-intensive applications.

RAID 1 mirroring protects valuable data that might be lost in the event of a hard drive failure.

RAID 5 array contains three or more hard drives where the data is divided into manageable blocks called strips. Parity is a mathematical method for recreating data that was lost from a single drive, which increases fault-tolerance. The data and parity are striped across all the hard drives in the array. The parity is striped in a rotating sequence to reduce bottlenecks associated with the parity calculations.

RAID 10 array uses four hard drives to create a combination of RAID levels 0 and 1. The data is striped across a two-drive array forming the RAID 0 component. Each of the drives in the RAID 0 array is then mirrored by a RAID 1 component.

## 10.2 SATA RAID Driver and Utility Setup

The driver is in the CD's "06\_Intel RAID\_AHCI" folder. Go to the directory and follow Intel's installation guide to install the driver and utility.

**Note!** For the detailed installation instructions for the SATA RAID driver and utility, please check the User Guide in the driver CD.



**Note!** Before you install the Intel Rapid Storage Technology, please read the "readme.txt".



PCE-3029 don't support SATA RAID mode.

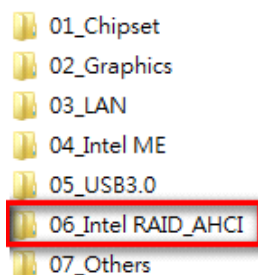

# Appendix **A**

Programming the  
Watchdog Timer

---

## A.1 Introduction

The PCE-3029/4129's watchdog timer can be used to monitor system software operation and take corrective action if the software fails to function within the programmed period. This section describes the operation of the watchdog timer and how to program it.

### A.1.1 Watchdog timer overview

The watchdog timer is built in to the NCT6776D super I/O controller. It provides the following user programmable functions:

- Can be enabled and disabled via user's program
- Timer can be set from 1 to 255 seconds or 1 to 255 minutes
- Generates a reset signal if the software fails to reset the timer before time-out

### A.1.2 Programming the watchdog timer

The I/O port address of the watchdog timer is 2E (hex) and 2F (hex). 2E (hex) is the address port. 2F (hex) is the data port. You must first write an address value into address port 2E (hex), then write/read data to/from the assigned register through data port 2F (hex).

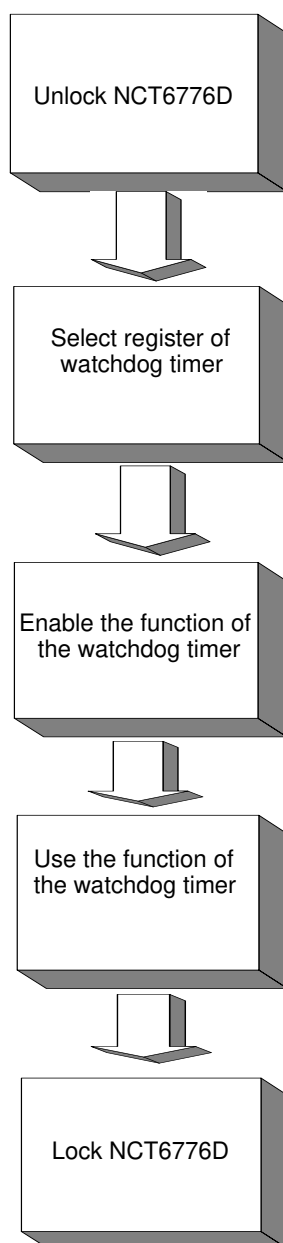
**Table A.1: Watchdog Timer Registers**

Address of register (2E)	Attribute Read/Write	Value (2F) & description
87 (hex)	----	Write this address to I/O address port 2E (hex) twice to unlock the NCT6776D
07 (hex)	write	Write 08 (hex) to select register of watchdog timer.
30 (hex)	write	Write 01 (hex) to enable the function of the watchdog timer. Disabled is set as default.
F5 (hex)	write	Set seconds or minutes as units for the timer. Write 0 to bit 3: set second as counting unit. [default]. Write 1 to bit 3: set minutes as counting unit Write 1 to bit 4: Watchdog timer count mode is 1000 times faster. If bit 3 is 0, the count mode is 1/1000 seconds mode. If bit 3 is 1, the count mode is 1/1000 minutes mode.

F6 (hex)	write	0: stop timer [default] 01~FF (hex): The amount of the count, in seconds or minutes, depends on the value set in register F5 (hex). This number decides how long the watchdog timer waits for strobe before generating an interrupt or reset signal. Writing a new value to this register can reset the timer to count with the new value.
F7 (hex)	read/write	Bit 6: Write 1 to enable keyboard to reset the timer, 0 to disable.[default] Bit 5: Write 1 to generate a timeout signal immediately and automatically return to 0. [default=0] Bit 4: Read status of watchdog timer, 1 means timer is "timeout".
AA (hex)	-----	Write this address to I/O port 2E (hex) to lock the NCT6776D.

### A.1.3 Example program

1. Enable watchdog timer and set 10 sec. as timeout interval

```

;-----
Mov dx,2eh          ; Unlock NCT6776D
Mov al,87h
Out dx,al
Out dx,al
;-----
Mov al,07h          ; Select registers of watchdog timer
Out dx,al
Inc dx
Mov al,08h
Out dx,al
;-----
Dec dx              ; Enable the function of watchdog timer
Mov al,30h
Out dx,al
Inc dx
In al,dx
Or al,01h
Out dx,al
;-----
Dec dx              ; Set second as counting unit
Mov al,0f5h
Out dx,al
Inc dx
In al,dx
And al,not 08h
Out dx,al
;-----
Dec dx              ; Set timeout interval as 10 seconds and start counting
Mov al,0f6h

```



```

Out    dx,al
Inc    dx
Mov    al,10      ; 10 seconds
Out    dx,al

```

```

;-----

```

```

Dec dx          ; Lock NCT6776D
Mov    al,0aah
Out    dx,al

```

## 2. Enable watchdog timer and set 5 minutes as timeout interval

```

;-----

```

```

Mov dx,2eh      ; Unlock NCT6776D
Mov al,87h
Out dx,al
Out dx,al

```

```

;-----

```

```

Mov al,07h      ; Select registers of watchdog timer
Out    dx,al
Inc    dx
In     al,dx
Or     al,08h
Out    dx,al

```

```

;-----

```

```

Dec dx          ; Enable the function of watchdog timer
Mov    al,30h
Out    dx,al
Inc    dx
Mov    al,01h
Out    dx,al

```

```

;-----

```

```

Dec dx          ; Set minute as counting unit
Mov    al,0f5h
Out    dx,al
Inc    dx
In     al,dx
Or     al,08h
Out    dx,al

```

```

;-----

```

```

Dec dx          ; Set timeout interval as 5 minutes and start counting
Mov    al,0f6h
Out    dx,al
Inc    dx
Mov    al,5      ; 5 minutes
Out    dx,al

```

```

;-----

```

```
Dec dx          ; Lock NCT6776D
Mov  al,0aah
Out  dx,al
```

### 3. Enable watchdog timer to be reset by mouse

```
-----
Mov dx,2eh      ; Unlock NCT6776D
Mov al,87h
Out dx,al
Out dx,al
-----
Mov al,07h      ; Select registers of watchdog timer
Out  dx,al
Inc  dx
Mov  al,08h
Out  dx,al
-----
Dec dx          ; Enable the function of watchdog timer
Mov  al,30h
Out  dx,al
Inc  dx
In   al,dx
Or   al,01h
Out  dx,al
-----
Dec dx          ; Enable watchdog timer to be reset by mouse
Mov  al,0f7h
Out  dx,al
Inc  dx
In   al,dx
Or  al,80h
Out  dx,al
-----
Dec dx          ; Lock NCT6776D
Mov  al,0aah
Out  dx,al
```

### 4. Enable watchdog timer to be reset by keyboard

```
-----
Mov dx,2eh      ; Unlock NCT6776D
Mov al,87h
Out dx,al
Out dx,al
-----
Mov al,07h      ; Select registers of watchdog timer
```

```

Out    dx,al
Inc    dx
Mov    al,08h
Out    dx,al
;-----
Dec dx          ; Enable the function of watchdog timer
Mov    al,30h
Out    dx,al
Inc    dx
Mov    al,01h
Out    dx,al
;-----
Dec dx          ; Enables watchdog timer to be strobe reset by keyboard
Mov    al,0f7h
Out    dx,al
Inc    dx
In     al,dx
Or    al,40h
Out    dx,al
;-----
Dec dx          ; Lock NCT6776D
Mov    al,0aah
Out    dx,al

5.   Generate a time-out signal without timer counting
;-----
Mov dx,2eh      ; Unlock NCT6776D
Mov al,87h
Out dx,al
Out dx,al
;-----
Mov al,07h      ; Select registers of watchdog timer
Out  dx,al
Inc  dx
Mov  al,08h
Out  dx,al
;-----
Dec dx          ; Enable the function of watchdog timer
Mov  al,30h
Out  dx,al
Inc  dx
Mov  al,01h
Out  dx,al
;-----
Dec dx          ; Generate a time-out signal

```

---

```
Mov    al,0f7h
Out    dx,al    ;Write 1 to bit 5 of F7 register
Inc    dx
In     al,dx
Or    al,20h
Out    dx,al
;-----
Dec dx    ; Lock NCT6776D
Mov    al,0aah
Out    dx,al
```

# Appendix **B**

## I/O Pin Assignments

## B.1 Parallel Port Connector (LPT1)

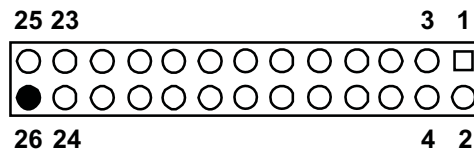
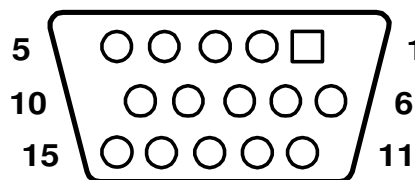

**Table B.1: Parallel Port Connector (LPT1)**

Pin	Signal	Pin	Signal
1	STROBE*	2	AUTOFD*
3	D0	4	GND
5	D1	6	INIT*
7	D2	8	SLCTINI*
9	D3	10	GND
11	D4	12	GND
13	D5	14	GND
15	D6	16	GND
17	D7	18	GND
19	ACK*	20	GND
21	BUSY	22	GND
23	PE	24	GND
25	SLCT	26	N/C

\* low active

## B.2 VGA Connector (VGA1)



**Table B.2: VGA Connector (VGA1)**

Pin	Signal	Pin	Signal
1	RED	9	VCC
2	GREEN	10	GND
3	BLUE	11	N/C
4	N/C	12	SDT
5	GND	13	H-SYNC
6	GND	14	V-SYNC
7	GND	15	SCK
8	GND		

## B.3 RS 232 Serial Port (COM12)

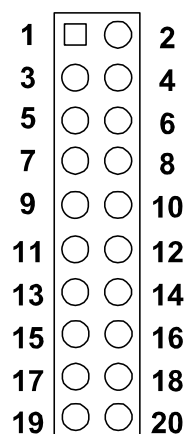

**Table B.3: RS-232 Serial Port (COM12)**

Pin	Signal
1	COM1_DCD
2	COM1_DSR
3	COM1_SIN
4	COM1_RTS
5	COM1_SOUT
6	COM1_CTS
7	COM1_DTR
8	COM1_RI
9	GND
10	GND
11	COM2_DCD
12	COM2_DSR
13	COM2_SIN
14	COM2_RTS
15	COM2_SOUT
16	COM2_CTS
17	COM2_DTR
18	COM2_RI
19	GND
20	GND

## B.4 USB 3.0 Header (USB23~USB89)

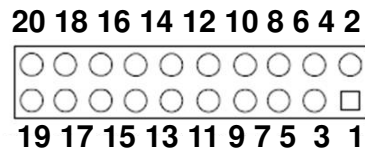

**Table B.4: USB 3.0 Header (USB23~USB89)**

Pin	Signal	Pin	Signal
1	+5V	11	USB_P+_P2
2	USB3.0_RXN_P1	12	USB_P-_P2
3	USB3.0_RXP_P1	13	GND
4	GND	14	USB3.0_TXP_P2
5	USB3.0_TXN_P1	15	USB3.0_TXN_P2
6	USB3.0_TXP_P1	16	GND
7	GND	17	USB3.0_RXP_P2
8	USB_P-_P1	18	USB3.0_RXN_P2
9	USB_P+_P1	19	+5V
10	Reserve		

## B.5 PS/2 Keyboard/Mouse Connector (KBMS1)

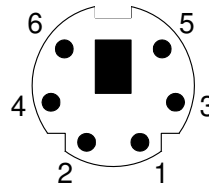
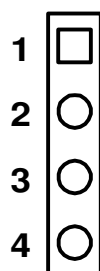

**Table B.5: PS/2 Keyboard/Mouse Connector (KBMS1)**

Pin	Signal
1	KB DATA
2	MS DATA
3	GND
4	VCC
5	KB CLOCK
6	MS CLOCK



## B.6 CPU Fan Power Connector (CPUFAN1)



**Table B.6: CPU Fan Power Connector (CPUFAN1)**

Pin	Signal
1	GND
2	+12V
3	Detect
4	NC

## B.7 Front Panel Connector (FP1)

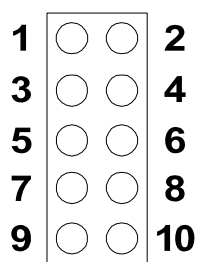

**Table B.7: Front Panel Connector (FP1)**

Pin	Signal
1	HDD_LED+
2	HDD_LED-
3	PW_LED
4	GND
5	SNMP_SCL
6	SNMP_SDA
7	RESET#
8	GND
9	PWR-BTN
10	GND

## B.8 High-definition Audio Link Connector (HDAUD1)

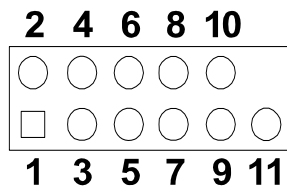

**Table B.8: High-definition Audio Link Connector (HDAUD1)**

Pin	Signal	Pin	Signal
1	ACZ_VCC	2	GND
3	ACZ_SYNC	4	ACZ_BITCLK
5	ACZ_SDOUT	6	ACZ_SDIN0
7	ACZ_SDIN1	8	-ACZ_RST
9	ACZ_12V	10	GND
11	GND	12	N/C

## B.9 LAN1 and LAN2 LED Connector (LANLED1)

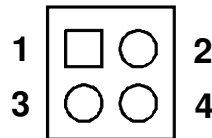

**Table B.9: LAN1 and LAN2 LED Connector (LANLED1)**

Pin	Signal
1	#LAN1_ACT
2	#LAN2_ACT
3	V33_AUX
4	V33_AUX

## B.10 GPIO Header (GPIO1)

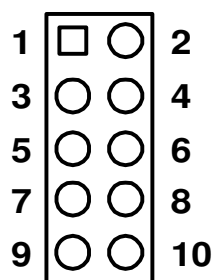

**Table B.10: GPIO Header (GPIO1)**

Pin	Signal
1	SIO_GPIO0
2	SIO_GPIO4
3	SIO_GPIO1
4	SIO_GPIO5
5	SIO_GPIO2
6	SIO_GPIO6
7	SIO_GPIO3
8	SIO_GPIO7
9	VCC_GPIO
10	GND

## B.11 JWDT1 and JOBS1

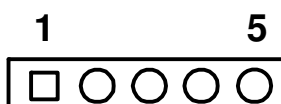

**Table B.11: JWDT1 and JOBS1**

Pin	Signal
1	N/C
2	SIO_WG#
3	SRST#
4	ERR_BEEP
5	OBS_BEEP

## B.12 JCASE1

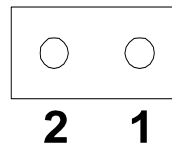

**Table B.12: JCASE1**

Pin	Signal
1	CASEOP#
2	GND

## B.13 LPC1

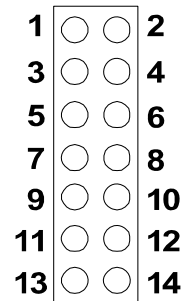

**Table B.13: LPC1**

Pin	Signal
1	CLK33M_LPC0
2	LPC_AD1
3	PLTRST_LPC0#
4	LPC_AD0
5	LPC_FRAME#
6	3.3V
7	LPC_AD3
8	GND
9	LPC_AD2
10	LPC1_SMB_CLK
11	PCI_SERIRQ
12	LPC1_SMB_DATA
13	5VSB
14	5VSB

## B.14 PWR1

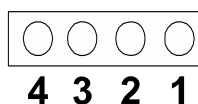

**Table B.14: PWR1**

Pin	Signal
1	5V
2	GND
3	GND
4	12V

## B.15 DP1, DVI1

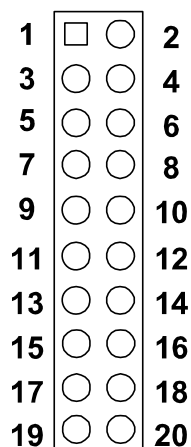

**Table B.15: DP1, DVI1**

Pin	Signal
1	GND
2	GND
3	DDPB TX0- B
4	DDPB TX3- B
5	DDPB TX0+ B
6	DDPB TX3+ B
7	GND
8	N/C
9	DDPB TX1- B
10	N/C
11	DDPB TX1+ B
12	TMDS0_DDB_DAT(PCE-4128) DDPB_AUX- (PCE-3028)
13	GND
14	TMDS0_DDB_CLK (PCE-4128) DDPB_AUX+ (PCE-3028)

**Table B.15: DP1, DVI1**

15	DDPB TX2- B
16	GND
17	DDPB TX2+ B
18	DDPB_HPD_Q
19	VCC_DP1
20	VCC_DP1

## B.16 Fixed I/O Ranges Decoded by Intel PCH

**Table B.16: Fixed I/O Ranges Decoded by PCH**

I/O Address	Read Target	Write Target	Internal Unit
20h - 21h	Interrupt Controller	Interrupt Controller	Interrupt
24h - 25h	Interrupt Controller	Interrupt Controller	Interrupt
28h - 29h	Interrupt Controller	Interrupt Controller	Interrupt
2Ch - 2Dh	Interrupt Controller	Interrupt Controller	Interrupt
2Eh - 2Fh	LPC/eSPI	LPC/eSPI	Forwarded to LPC/eSPI
30h - 31h	Interrupt Controller	Interrupt Controller	Interrupt
34h - 35h	Interrupt Controller	Interrupt Controller	Interrupt
38h - 39h	Interrupt Controller	Interrupt Controller	Interrupt
3Ch - 3Dh	Interrupt Controller	Interrupt Controller	Interrupt
40h	Timer/Counter	Timer/Counter	8254 Timer
42h - 43h	Timer/Counter	Timer/Counter	8254 Timer
4Eh - 4Fh	LPC/eSPI	LPC/eSPI	Forwarded to LPC/eSPI
50h	Timer/Counter	Timer/Counter	8254 Timer
52h - 53h	Timer/Counter	Timer/Counter	8254 Timer
60h	LPC/eSPI	LPC/eSPI	Forwarded to LPC/eSPI
61h	NMI Controller	NMI Controller	Processor I/F
62h	Microcontroller	Microcontroller	Forwarded to LPC/eSPI
63h	NMI Controller	NMI Controller	Processor I/F
64h	Microcontroller	Microcontroller	Forwarded to LPC/eSPI
65h	NMI Controller	NMI Controller	Processor I/F
66h	Microcontroller	Microcontroller	Forwarded to LPC/eSPI
67h	NMI Controller	NMI Controller	Processor I/F
70h	RTC Controller	NMI and RTC Controller	RTC
71h	RTC Controller	RTC Controller	RTC
72h	RTC Controller	RTC Controller	RTC
73h	RTC Controller	RTC Controller	RTC
74h	RTC Controller	RTC Controller	RTC
75h	RTC Controller	RTC Controller	RTC
76h - 77h	RTC Controller	RTC Controller	RTC
80h	LPC/eSPI or PCIe	LPC/eSPI or PCIe	LPC/eSPI or PCIe
84h - 86h	Reserved	LPC/eSPI or PCIe	LPC/eSPI or PCIe
88h	Reserved	LPC/eSPI or PCIe	LPC/eSPI or PCIe
8Ch - 8Eh	Reserved	LPC/eSPI or PCIe	LPC/eSPI or PCIe
90h	(Alias to 80h)	(Alias to 80h)	Forwarded to LPC/eSPI

92h	Reset Generator	Reset Generator	Processor I/F
94h - 96h	(Alias to 80h)	(Alias to 80h)	Forwarded to LPC/eSPI
98h	(Alias to 80h)	(Alias to 80h)	Forwarded to LPC/eSPI
9Ch - 9Eh	(Alias to 80h)	(Alias to 80h)	Forwarded to LPC/eSPI
A0h - A1h	Interrupt Controller	Interrupt Controller	Interrupt
A4h - A5h	Interrupt Controller	Interrupt Controller	Interrupt
A8h - A9h	Interrupt Controller	Interrupt Controller	Interrupt
ACh - Adh	Interrupt Controller	Interrupt Controller	Interrupt
B0h - B1h	Interrupt Controller	Interrupt Controller	Interrupt
B2h - B3h	Power Management	Power Management	Power Management
B4h - B5h	Interrupt Controller	Interrupt Controller	Interrupt
B8h - B9h	Interrupt Controller	Interrupt Controller	Interrupt
BCh - BDh	Interrupt Controller	Interrupt Controller	Interrupt
200 - 207h	Gameport Low	Gameport Low	Forwarded to LPC/eSPI
208-20Fh	Gameport Low	Gameport Low	Forwarded to LPC/eSPI
4D0h -4D1h	Interrupt Controller	Interrupt Controller	Interrupt Controller
CF9h	Reset Generator	Reset Generator	Interrupt controller

## B.17 System I/O Ports

**Table B.17: System I/O Ports**

I/O Address (Hex)	Device
A10h-A1Fh	H/W Monitor
2F8h-2FFh	Communication Port (COM2)
378h-37Fh	ECP Printer Port (LPT1)
3B0h-3BBh	Graphics
3C0h-3DFh	Graphics
3F8h-3FFh	Communication Port (COM1)
1800h-18FFh	PMBASE
778h-77Fh	ECP Printer Port
240h-25Fh	Communication Port for PCA-COM232/485 module

## B.18 Interrupt Assignments

**Table B.18: Interrupt Assignments**

Interrupt#	Interrupt source
IRQ0	System timer
IRQ1	Keyboard
IRQ2	Interrupt from controller 2 (cascade)
IRQ3	Communication port (COM2)
IRQ4	Communication port (COM1)
IRQ5	Available
IRQ6	Not available
IRQ7	LPT
IRQ8	System COMS/Real-time clock

IRQ9	SCI IRQ
IRQ10	Available
IRQ11	Communication port for PCA-COM232 module
IRQ12	PS/2 mouse
IRQ13	Numeric data processor
IRQ14	Not available
IRQ15	Not available

## B.19 1 MB Memory Map

**Table B.19: 1 MB memory map**

Address Range	Device
E8000h - FFFFFh	BIOS
D0000h - E7FFFh	Unused
C0000h - CFFFFh	VGA BIOS
A0000h - BFFFFh	Video Memory
00000h - 9FFFFh	Base memory



# Appendix **C**

Programming the  
GPIO

## C.1 Supported GPIO Register

Below are the detailed descriptions of the GPIO addresses and a programming sample.

## C.2 GPIO Registers

Bank	Offset	Description
09h	30h	Write 1 to bit 7 to enable GPIO
07h	E0h	GPIO I/O Register When set to a '1', respective GPIO port is programmed as an input port. When set to a '0', respective GPIO port is programmed as an output port.
07h	E1h	GPIO Data Register If a port is programmed to be an output port, then its respective bit can be read/written. If a port is programmed to be an input port, then its respective bit can only be read.
07h	E2h	GPIO Inversion Register When set to a '1', the incoming/outgoing port value is inverted. When set to a '0', the incoming/outgoing port value is the same as in data register.

## C.3 GPIO Example Program-1

-----  
Enter the extended function mode, interruptible double-write  
-----

```
MOV DX,2EH  
MOV AL,87H  
OUT DX,AL  
OUT DX,AL
```

-----  
Configure logical device, configuration register CRE0,CRE1,CRE2  
-----

```
MOV DX,2EH  
MOV AL,09H  
OUT DX,AC  
DEC DX  
MOV AL,30H  
OUT DX,AL  
INC DX  
IN AL,DX  
OR AL,10000000B  
DEC DX  
MOV AL,07H  
OUT DX,AL
```

```
INC DX
MOV AL,07H ; Select logical device 7
OUT DX,AL ;
DEC DX
MOV AL,E0H
OUT DX,AL
INC DX
MOV AL,00H ; 1:Input 0:output for GPIO respective
OUT DX,AL
DEC DX
MOV AL,E2H ;
OUT DX,AL
INC DX
MOV AL,00H ;Set GPIO is normal not inverter
OUT DX,AL;
DEC DX
MOV AL,E1H
OUT DX,AL
INC DX
MOV AL,??H ; Put the output value into AL
OUT DX,AL

-----
Exit extended function mode |
-----

MOV DX,2EH
MOV AL,AAH
OUT DX,AL
```

**ADVANTECH**

*Enabling an Intelligent Planet*

**[www.advantech.com](http://www.advantech.com)**

Please verify specifications before quoting. This guide is intended for reference purposes only.

All product specifications are subject to change without notice.

No part of this publication may be reproduced in any form or by any means, electronic, photocopying, recording or otherwise, without prior written permission of the publisher.

All brand and product names are trademarks or registered trademarks of their respective companies.

© Advantech Co., Ltd. 2016