

LMT70EVM Booster Pack

User's Guide



Literature Number: SNIU024B
January 2015—Revised August 2015

1	Introduction	3
2	LMT70EVM Components	4
3	Software Installation	5
	3.1 Graphical User Interface (GUI).....	5
	3.2 Firmware.....	7
	3.2.1 Firmware Check.....	7
	3.2.2 Firmware Installation.....	8
4	LMT70 Setup and Operation	9
	4.1 Quickstart Guide.....	9
	4.2 Remote Temperature Sensing with the LMT70EVM.....	14
5	Troubleshooting	16
	5.1 LMT70EVM Driver Installation.....	16
	5.2 LMT70EVM Hard Firmware Installation.....	17
6	Board Layout	19
7	Schematic	21
8	Bill of Materials	23
	Revision History	24

Introduction

The LMT70EVM allows users to evaluate the performance of the LMT70 temperature sensor. The EVM comes in a USB stick form factor package with an onboard MSP430F5528 microcontroller that interfaces with both the USB host computer and the LMT70 device. The EVM also comes with perforated slots that the user can break apart to separate the microcontroller and LMT70 device for remote temperature measurements.

LMT70EVM Components

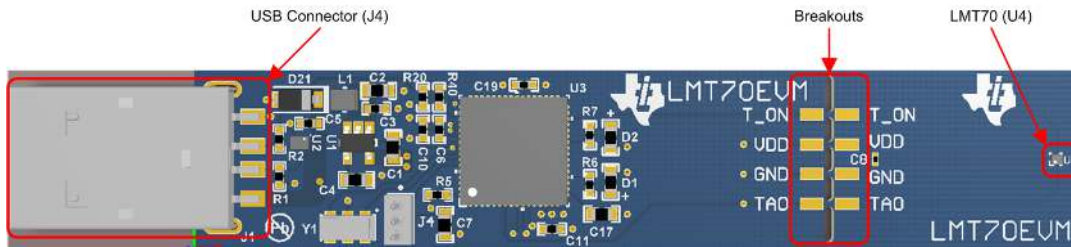

Figure 2-1. LMT70EVM Evaluation Board

Table 2-1. Device and Package Configurations

DEVICE	IC	PACKAGE
U4	LMT70	WLCSP

Software Installation

3.1 Graphical User Interface (GUI)

Install the LMT70EVM Software:

1. Go to the LMT70EVM webpage available [here](#) on the TI website. Scroll down to the “Software” section and download the latest evaluation software.
2. Unzip the downloaded file into a known directory, and run the “setup.exe” file located in [Unzip location]\LMT70EVM Installer-vx.x.x.xx\LMT70EVM Installer\Volume. Follow the pop-screen instructions by clicking the “Next” button to install the software and accept the license agreement.

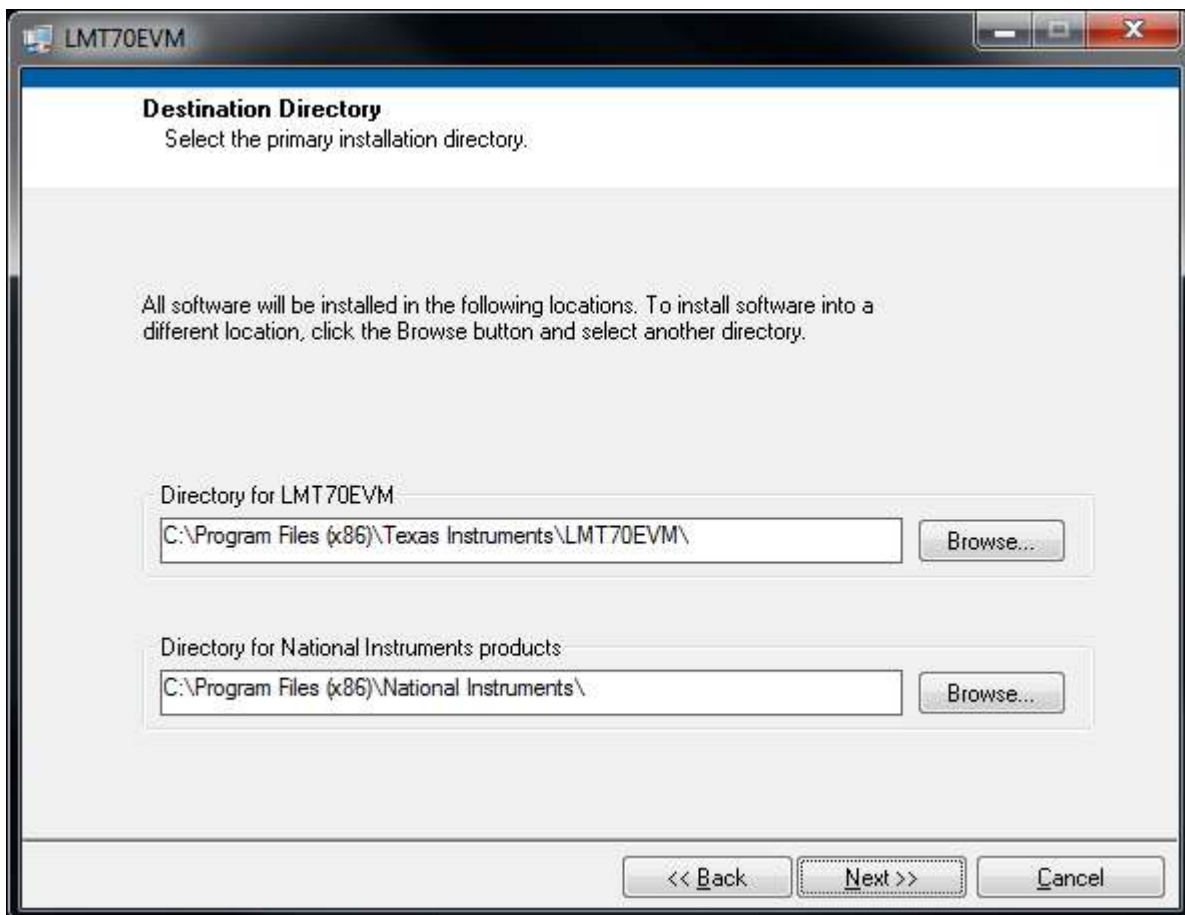

Figure 3-1. LMT70EVM Installation Directory

- When the installation is finished, please click the “Finish” button.

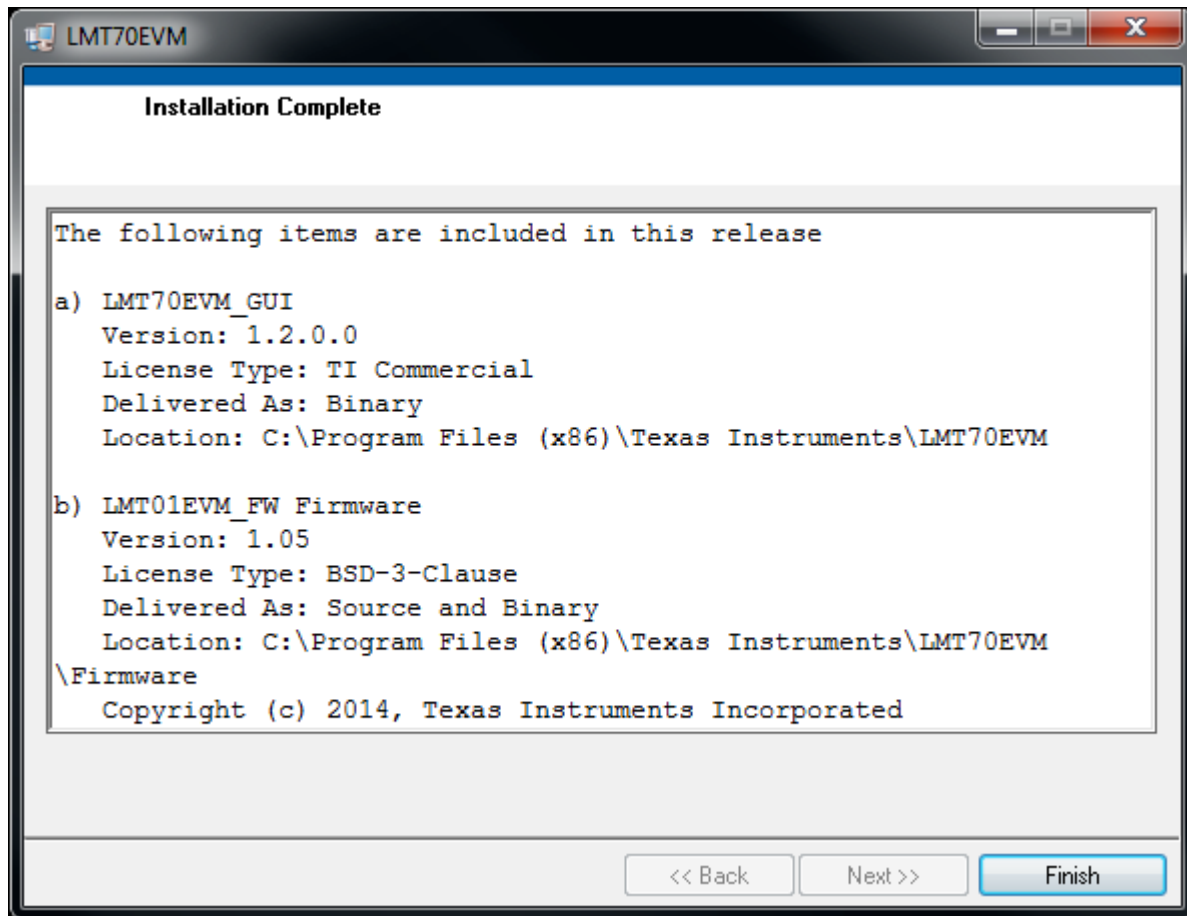

Figure 3-2. LMT70EVM Installation Finish

3.2 Firmware

3.2.1 Firmware Check

1. Run the LMT70EVM and go to the SETUP tab and click “R” in the Firmware Revision box.

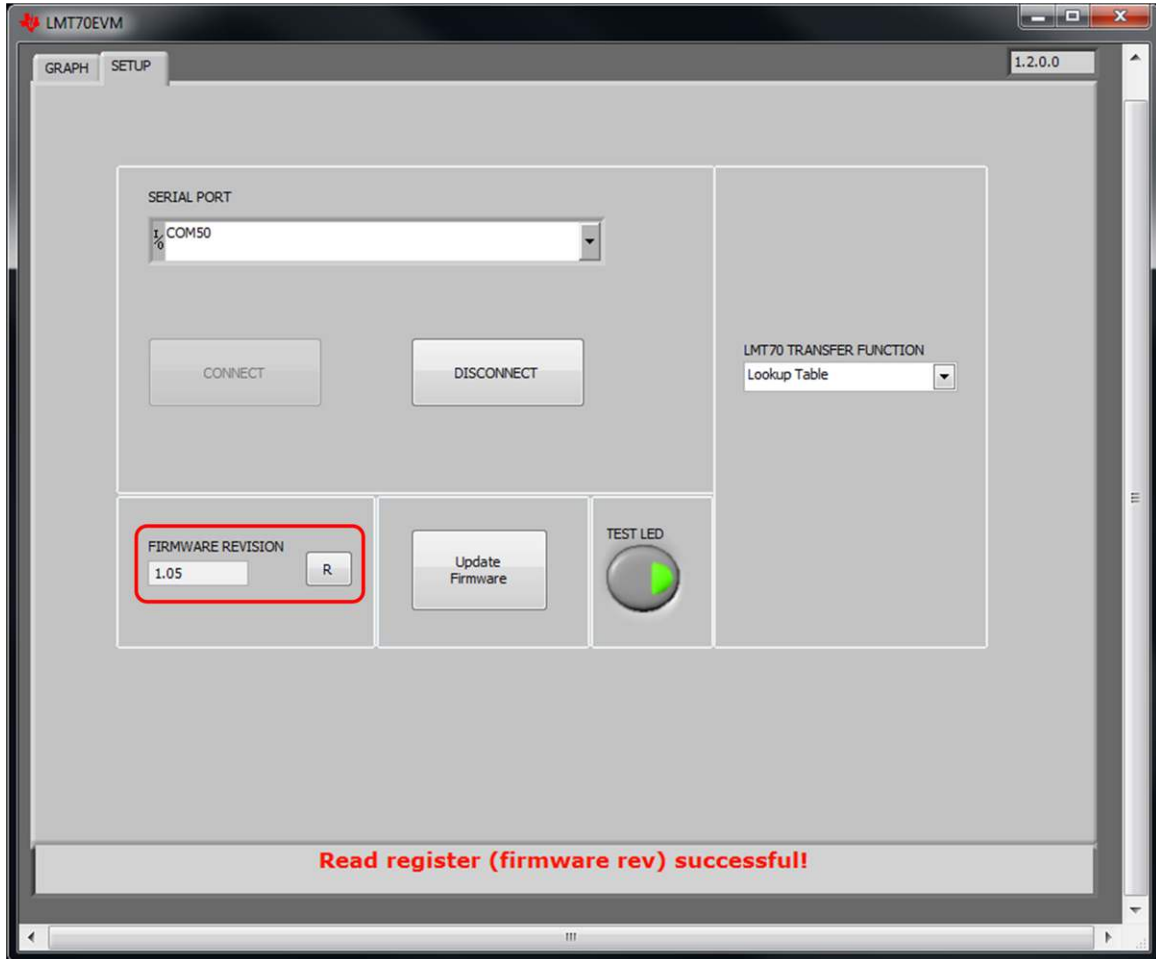

Figure 3-3. Firmware Revision Number

2. Check the firmware revision number in the Firmware Revision box if it is the same revision found in C:\Program Files (x86)\Texas Instruments\LMT70EVM\Firmware\LMT70EVM-vx.xx.txt. If the firmware revision numbers are different then proceed to Firmware Installation, otherwise proceed to [Chapter 4](#).

3.2.2 Firmware Installation

1. The firmware is located at C:\\Program Files (x86)\\Texas Instruments\\LMT70EVM\\Firmware\\LMT70EVM-v0.xx.txt
2. Open the LMT70EVM GUI and go to the “Setup” tab. Click on the “Update Firmware” button. The MSP430 USB Firmware Upgrade program will launch.
3. Click “Next” to proceed on the first prompt; read and accept the license agreement and click “Next” to continue.

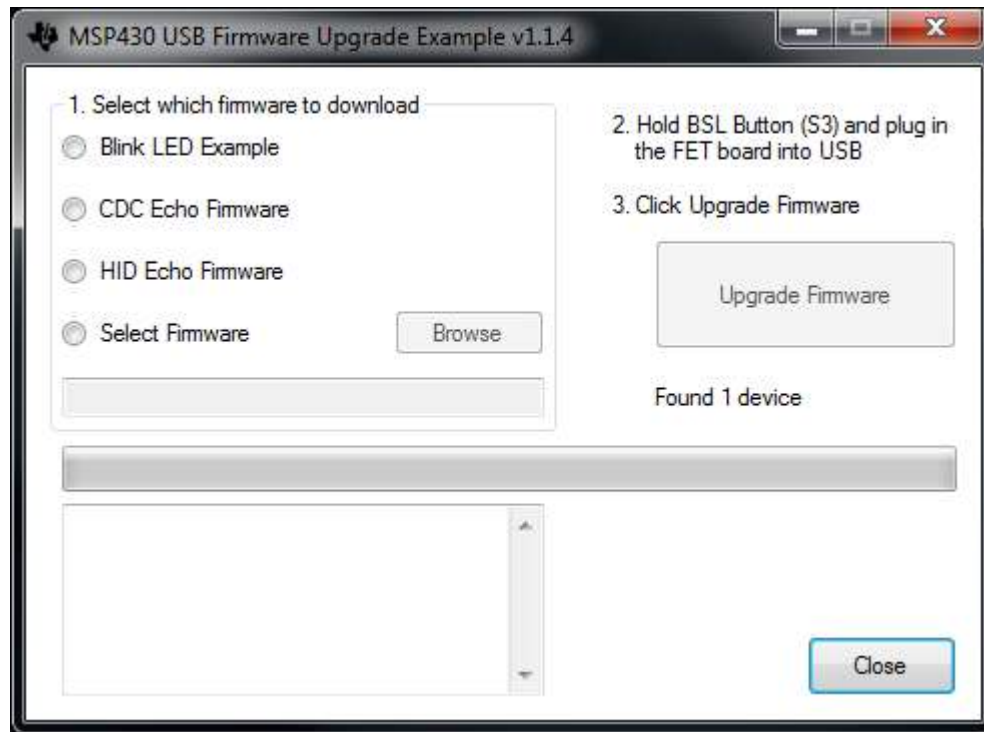

Figure 3-4. USB Firmware Upgrade Window

4. Make sure the MSP430 USB Firmware Upgrade Example window shows “Found 1 device”.
5. Enable the Select Firmware button and browse to open the downloaded firmware “LMT70EVM-vx.xx.txt”.
6. Click on the Upgrade Firmware button to program the LMT70EVM. Close and relaunch the application when done.

LMT70 Setup and Operation

4.1 Quickstart Guide

1. Connect the LMT70EVM to a USB port on a PC.
2. One red and one green LED should turn on and not blink when the EVM is initially plugged into the PC. The red LED will blink if the power on reset tests on the MSP430 microcontroller fails on startup or if the Test LED button is toggled. The green LED will blink when the Start Graph button is pressed.
3. Launch the LMT70EVM software by clicking on Start >> All Program >> Texas Instruments >> LMT70EVM >> LMT70EVM. The LMT70EVM GUI should automatically connect to the appropriate COM port. If there is a connection problem please check in the Control Panel >> Device Manager >> Ports and verify if the LMT70EVM has an established connection with the PC.

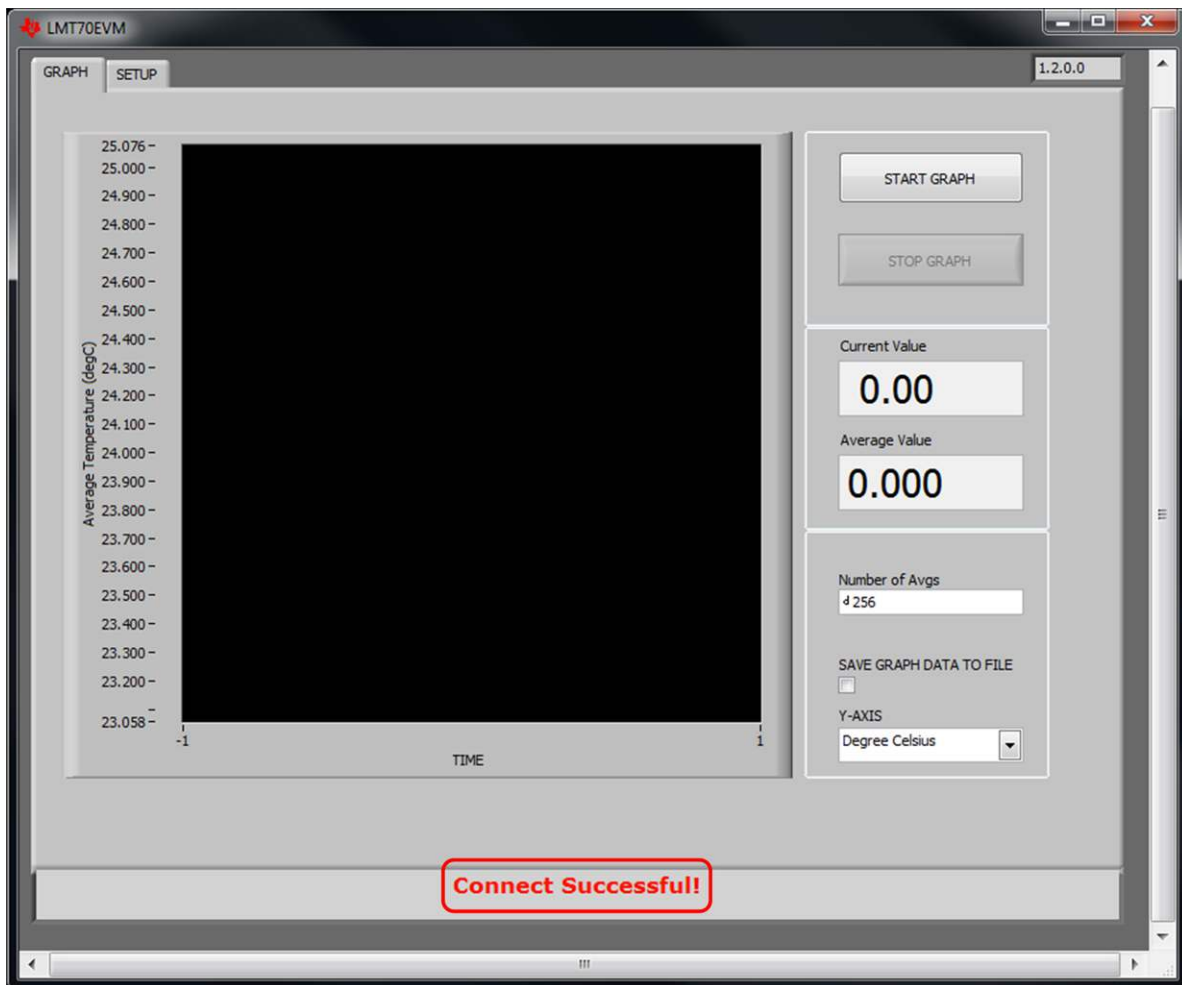

Figure 4-1. LMT70EVM Successful Connection with PC

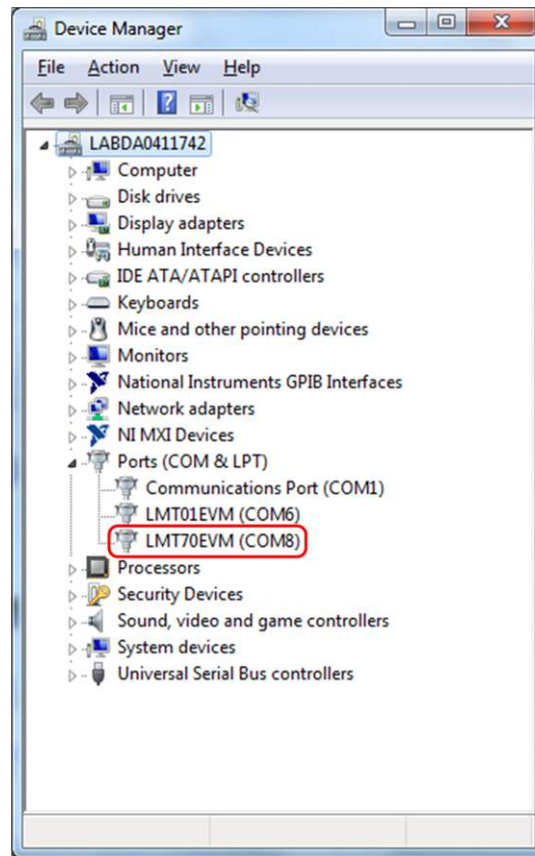

Figure 4-2. LMT70EVM COM Port

4. GRAPH Tab GUI Description

- Start Graph: Graph displays the running average data in degrees Celsius, millivolts, or ADC code
- Stop Graph: Graph stops updating
- Current Value: Shows the current value being read
- Average Value: Shows the running average value set by the Number of Avgs field
- Number of Avgs: Number of running average temperature readings before being displayed on the graph and Average Value field
- Save Graph Data to File: Save the temperature data to a .csv file
- Y-axis: Y-axis is shown in degrees Celsius, millivolts, or ADC code

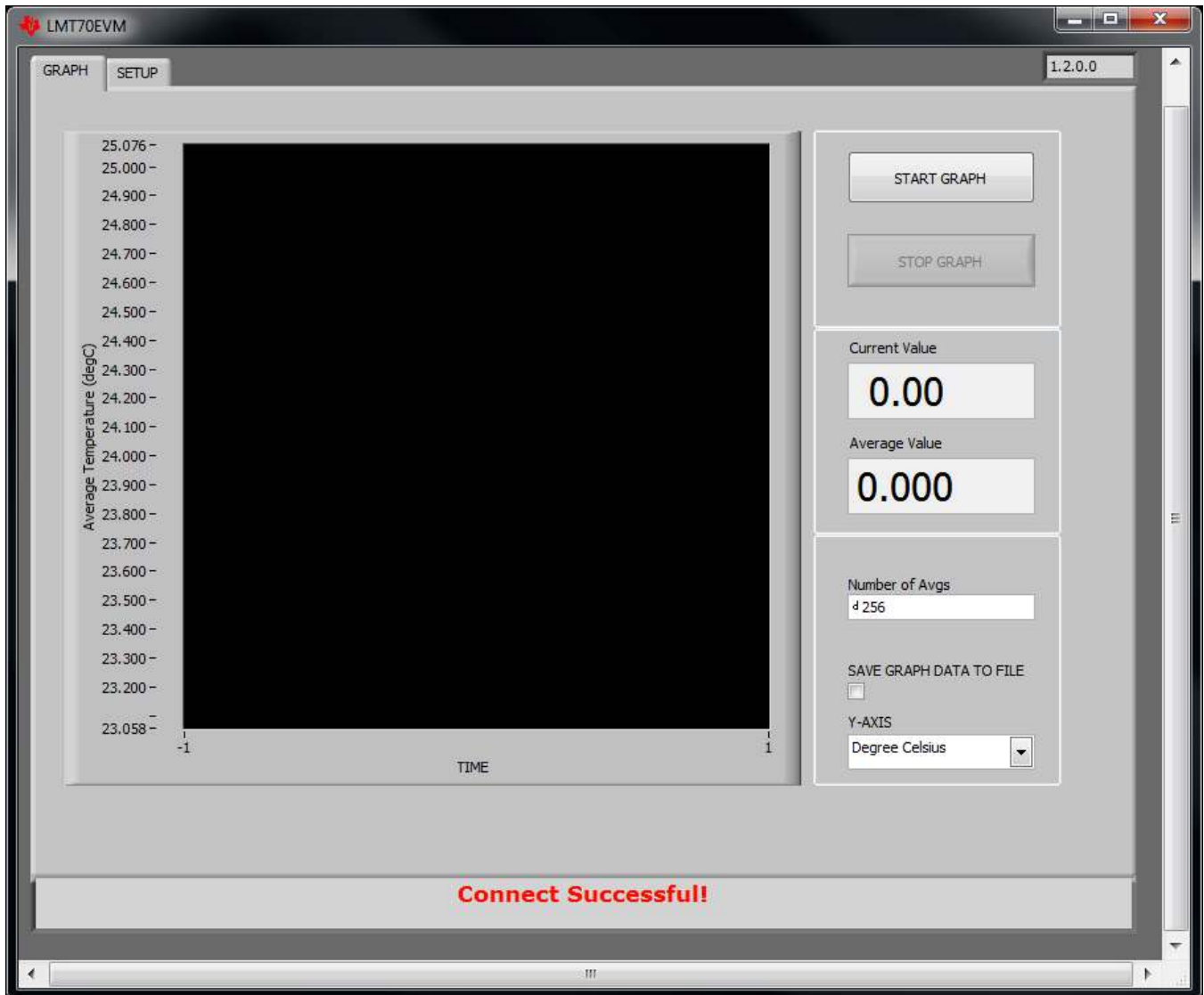

Figure 4-3. GRAPH Tab Page

5. SETUP Tab GUI Description

- Serial Port: It allows user to select manually which serial port the LMT70EVM is connected to
- Firmware Revision: Check which firmware revision is on the MSP430F5528 microcontroller
- Update Firmware: Launches the MSP430 USB Firmware Upgrade Example software to manually update the firmware
- Test LED: Toggles LED on the LMT70EVM board
- LMT70 Transfer Function: Choose method of converting LMT70 output voltage to temperature

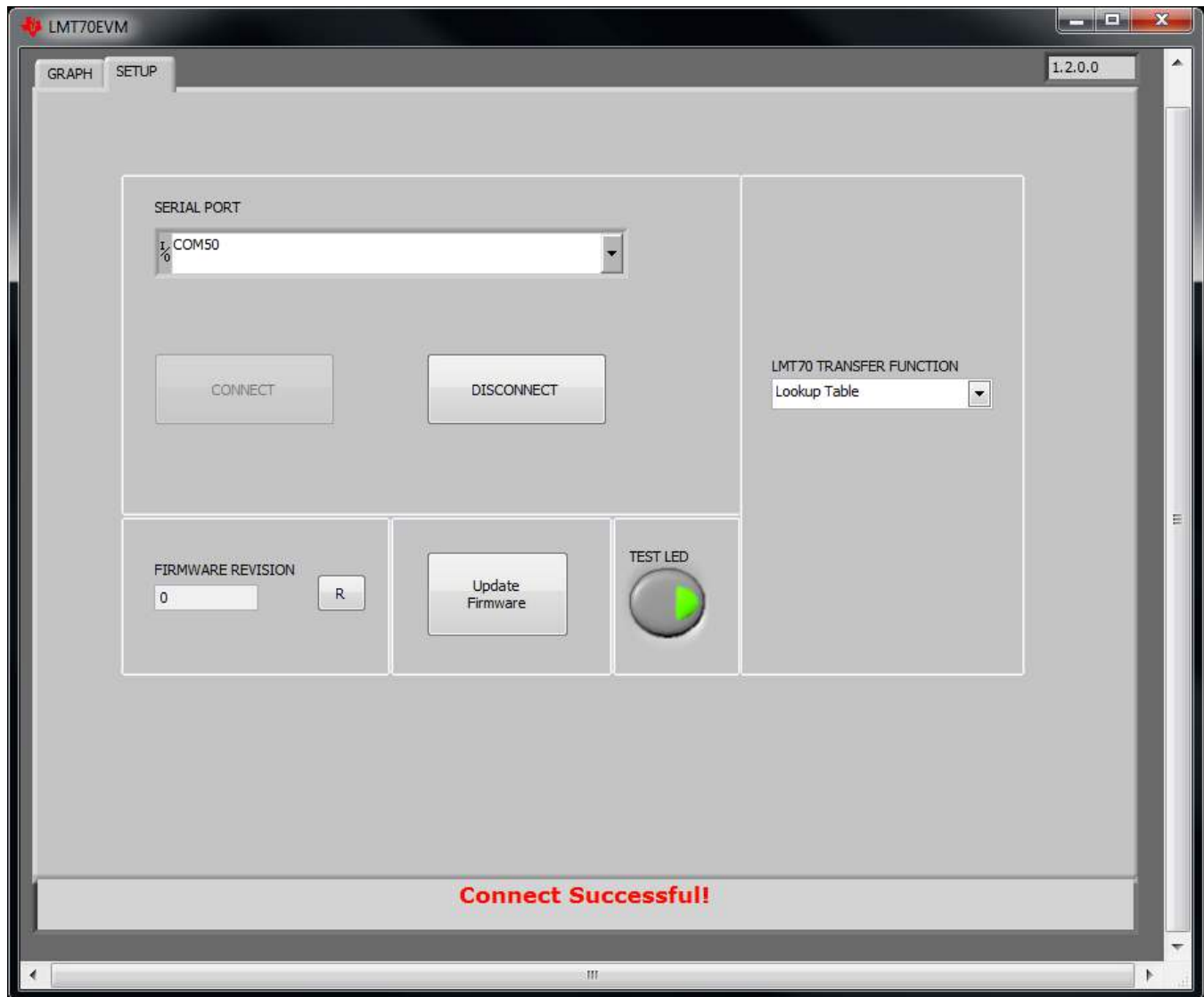

Figure 4-4. SETUP Tab Page

- Start the GUI by pressing the “Start Graph” button on the GRAPH tab. The graph should show updated temperature readings from the LMT70 part. Press a finger against the LMT70 part at U4 and observe the temperature change.

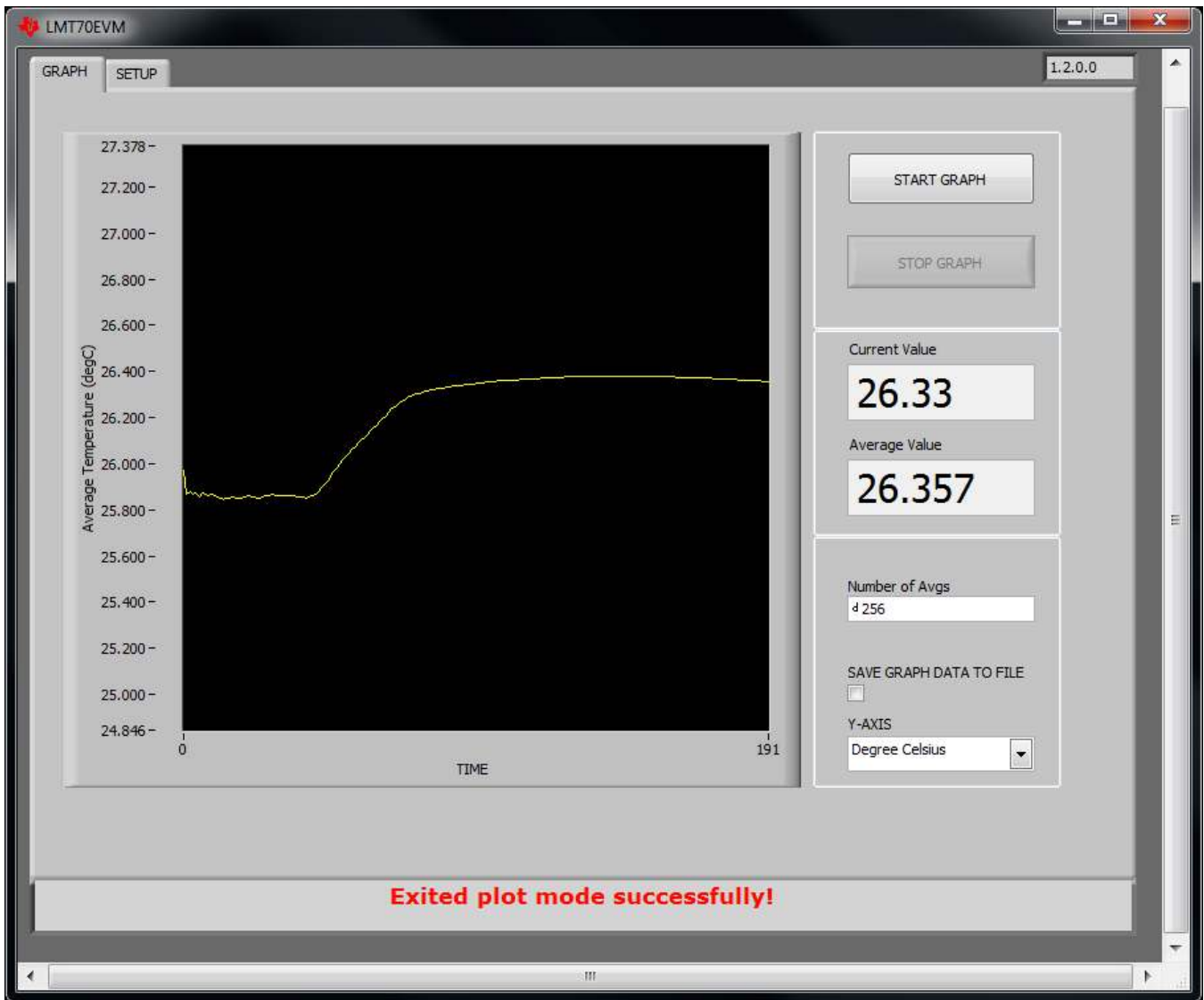

Figure 4-5. Temperature Change by Pressing Finger on LMT70

4.2 Remote Temperature Sensing with the LMT70EVM

1. The LMT70EVM comes with perforated slots where the user can snap apart the LMT70 device side and microcontroller side of the EVM. The user can either connect the LMT70 side to the microcontroller side with wires/header or the user can connect the LMT70 side onto their own device/board.

NOTE: Do NOT use your hands to break apart the EVM. Instead use a pair of strong wire cutter or tiny hand saws. This is to create a clean cut on the perforated slots and to prevent U4 from popping off the PCB.

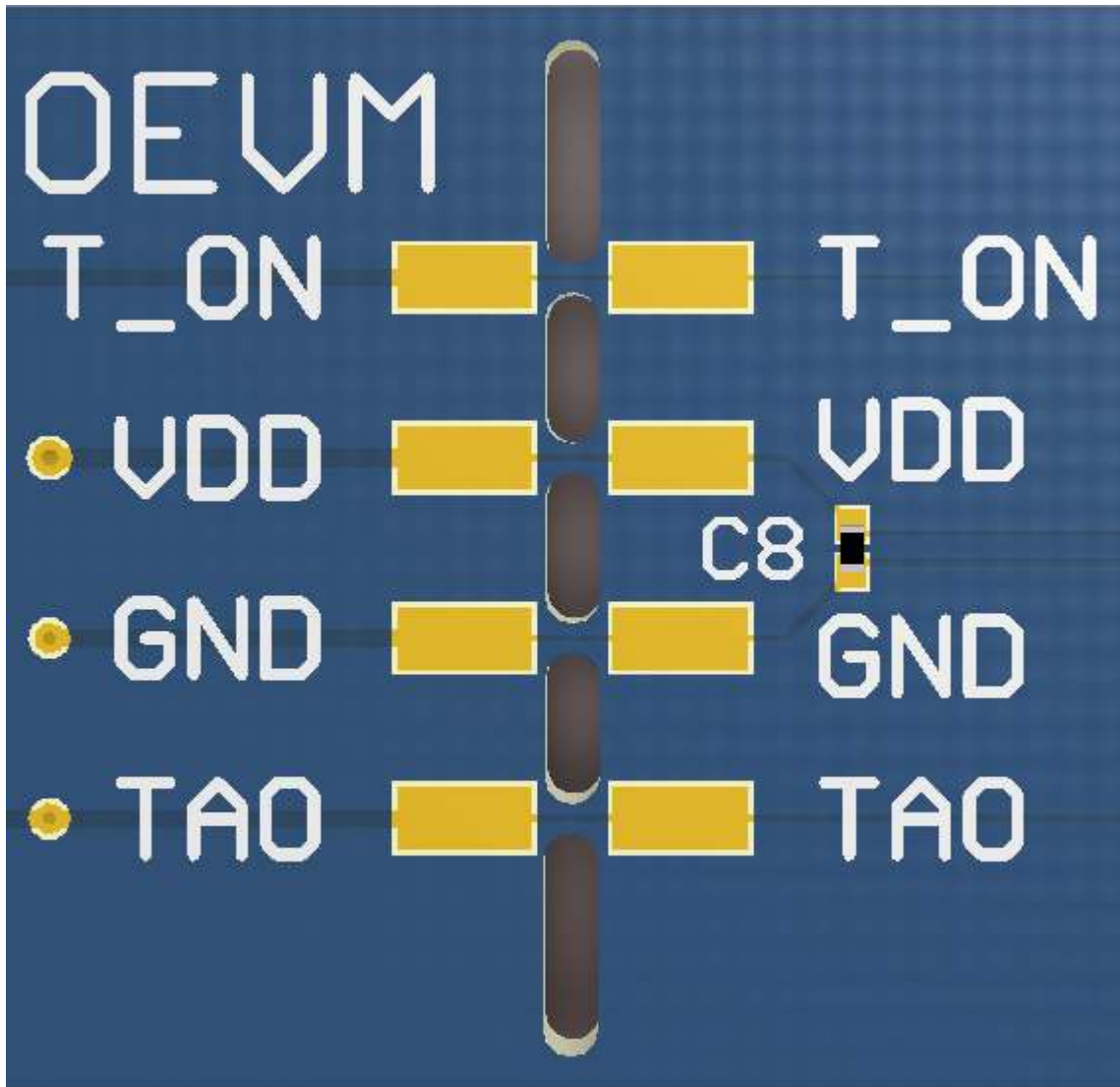

Figure 4-6. Breakout Slots and Exposed Pads

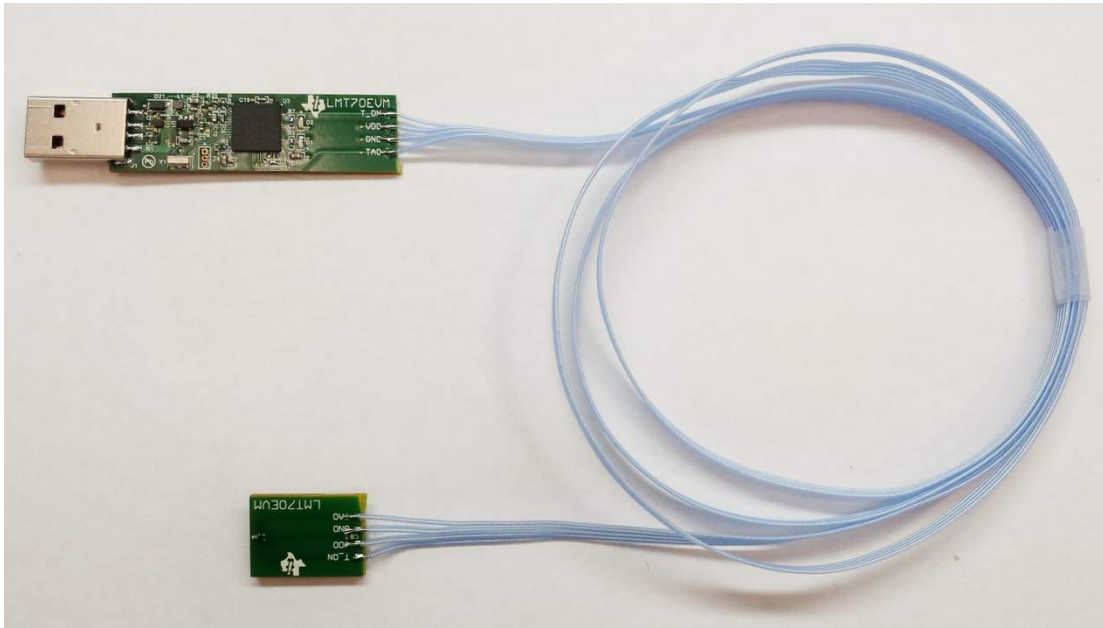

Figure 4-7. LMT70EVM with LMT70 Device and Microcontroller Connected with Wires

Troubleshooting

5.1 LMT70EVM Driver Installation

The LMT70EVM Driver automatically installs during the GUI installation. However, the LMT70EVM board may have been inserted into the USB port before the GUI installation. In such cases the EVM board could be associated with another driver. Complete the following steps if you do not see LMT70EVM and instead see MSP430-USB Example in the Device Manager window:

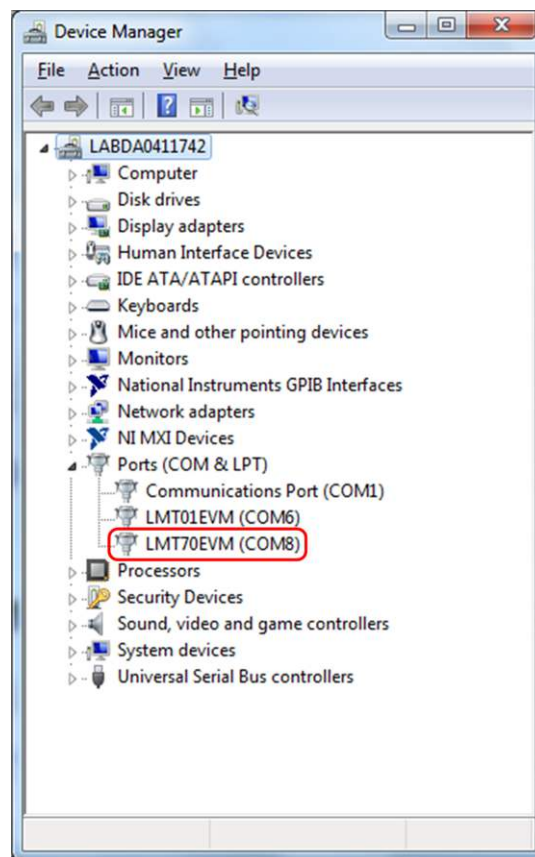

Figure 5-1. Device Manager with COM Port Name

1. Open the Device Manager and find the MSP430-USB Example device.
2. Right click it and choose Update Driver Software.
3. Select Browse my Computer for driver installation. Navigate to the installation directory, select the Firmware folder, and select the LMT70EVM_DRIVER.inf file.
4. Close the setup window when the installation is complete. The Device Manager should now display LMT70EVM followed by a COM port number.

5.2 LMT70EVM Hard Firmware Installation

During firmware flashing, the installation process could have been halted or quit unexpectedly. This process could put the EVM board into an unknown state and the EVM cannot be found in the Device Manager. To restore access to the EVM board, complete the following steps:

1. Short the two points as shown in [Figure 5-2](#).

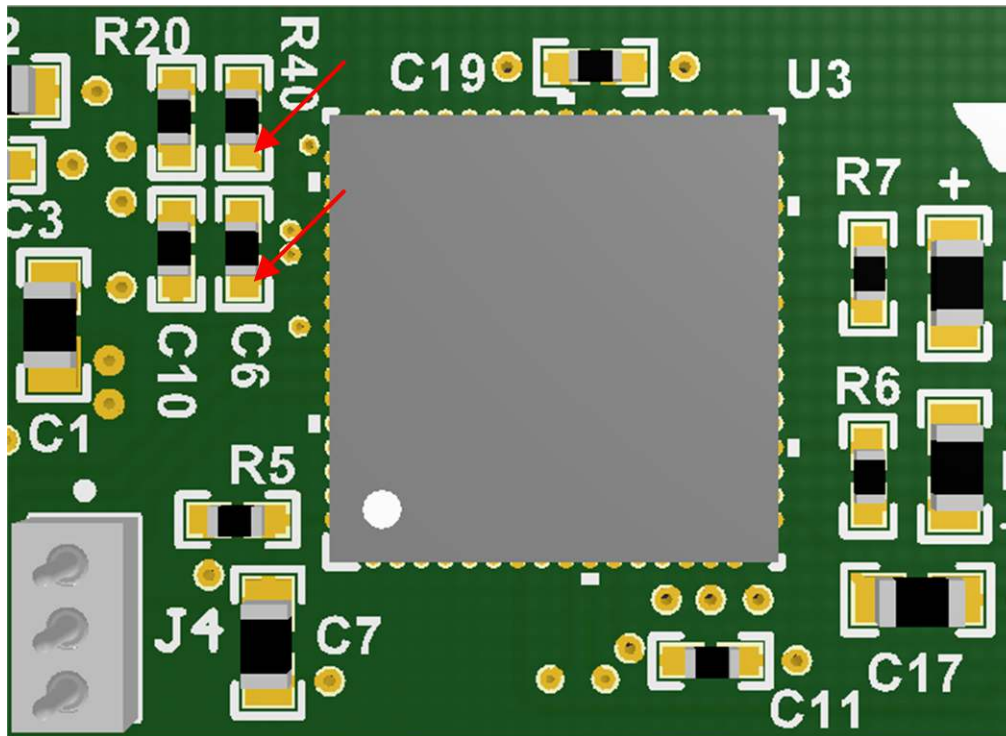

Figure 5-2. Short a Wire at These Locations

2. Connect the LMT70EVM board to the USB port and disconnect the short.
3. Start the LMT70EVM GUI. Press OK to the pop up error message “Auto Connect Failed! Check port number.”
4. Go to the “SETUP” tab and select “Update Firmware”. Select OK to the message “Update MSP430 Firmware?” Accept the license and the message “Found 1 device” should appear as in [Figure 5-3](#).

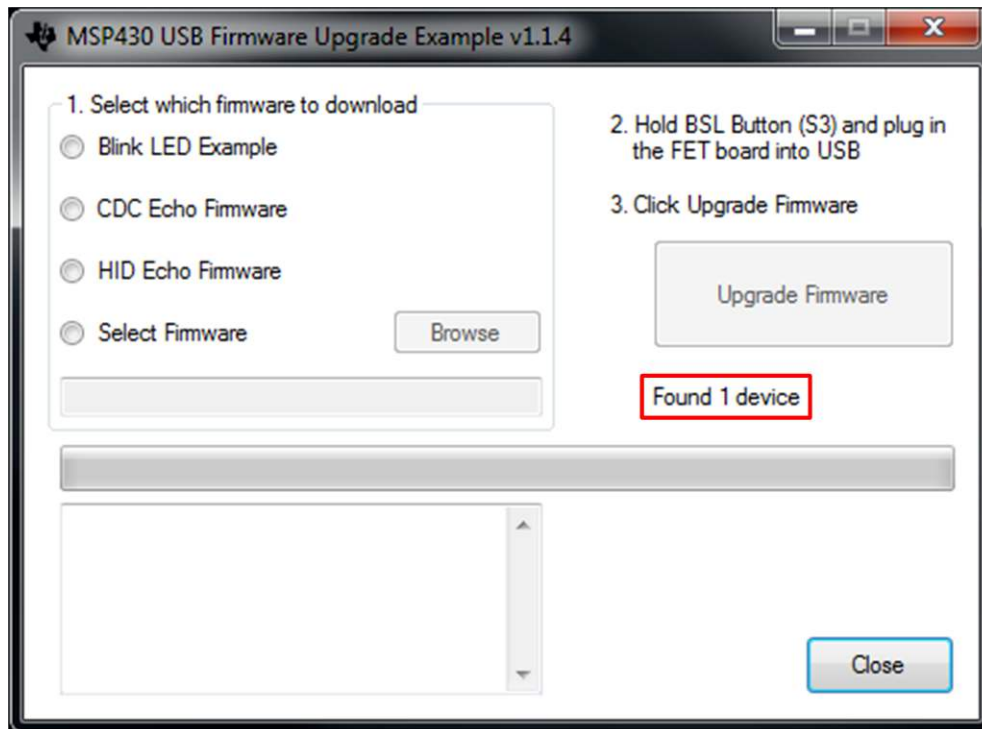

Figure 5-3. USB Firmware Upgrade Window

5. Choose “Select Firmware” and browse to the installation directory and go to the Firmware folder. Select “LMT70EVM_Firmware-vx.xx.txt”. Click “Upgrade Firmware” and close when done.
6. Exit the GUI. Disconnect and reconnect the EVM board.
7. Relaunch the GUI. The EVM board should now be connected and the board should work properly with the latest firmware.

Board Layout

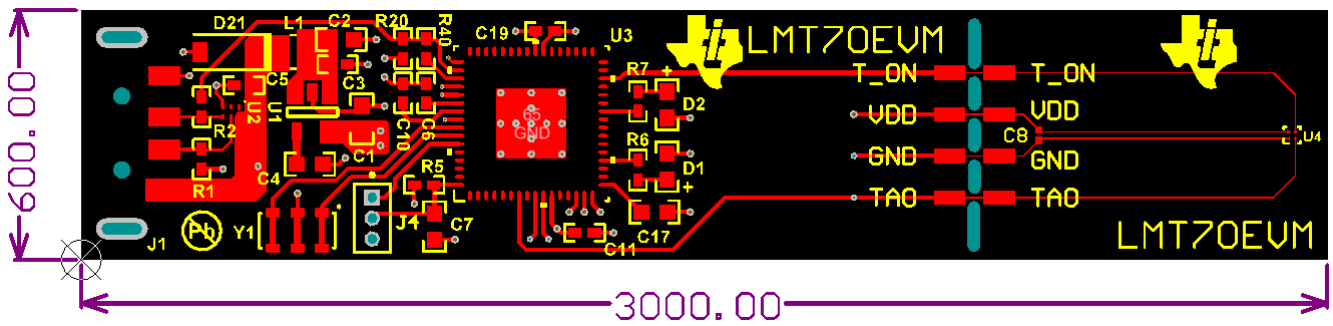

Figure 6-1. Top Assembly Layer

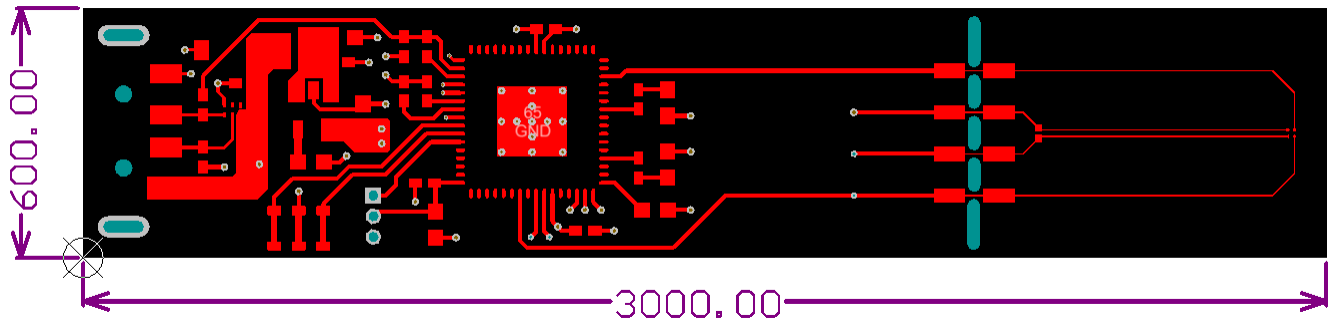

Figure 6-2. Top Layer Routing

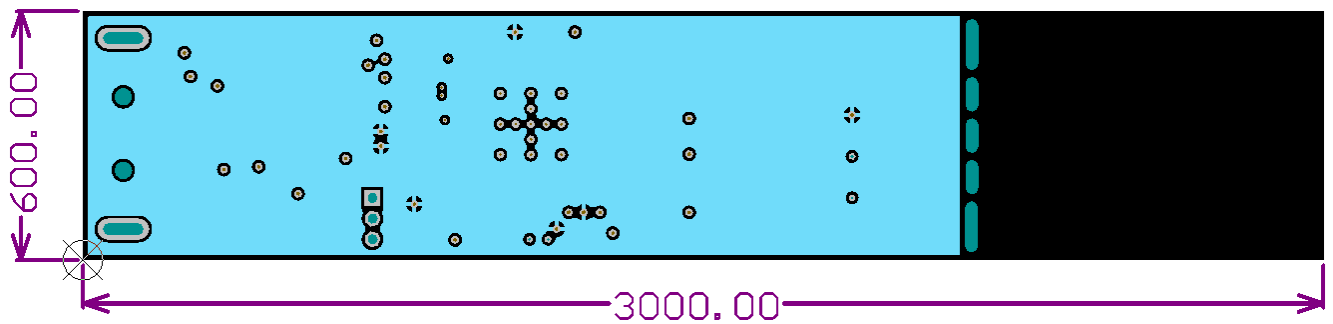

Figure 6-3. Power Layer Routing

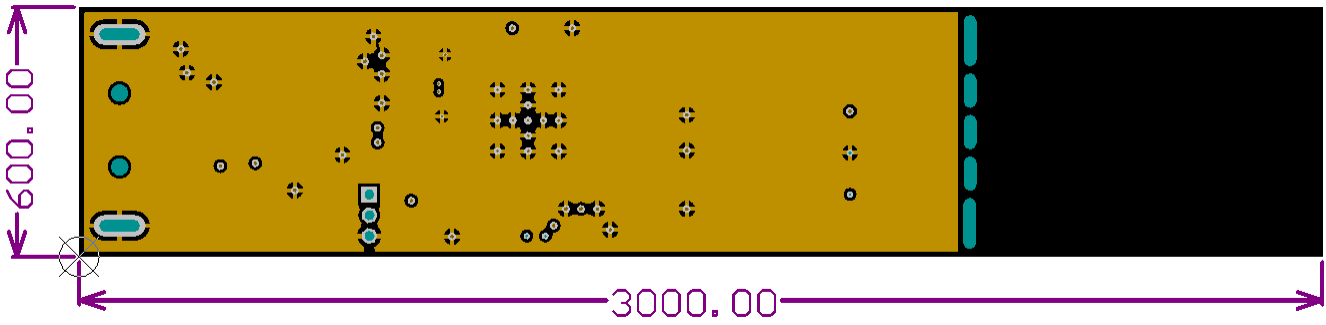

Figure 6-4. Ground Layer Routing

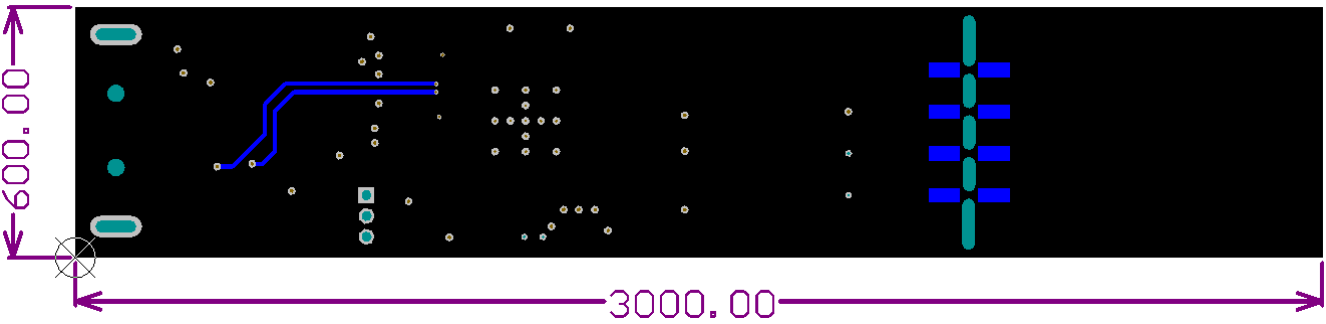

Figure 6-5. Bottom Layer Routing



Figure 6-6. Bottom Assembly Layer

Schematic

See next page for the graphic.

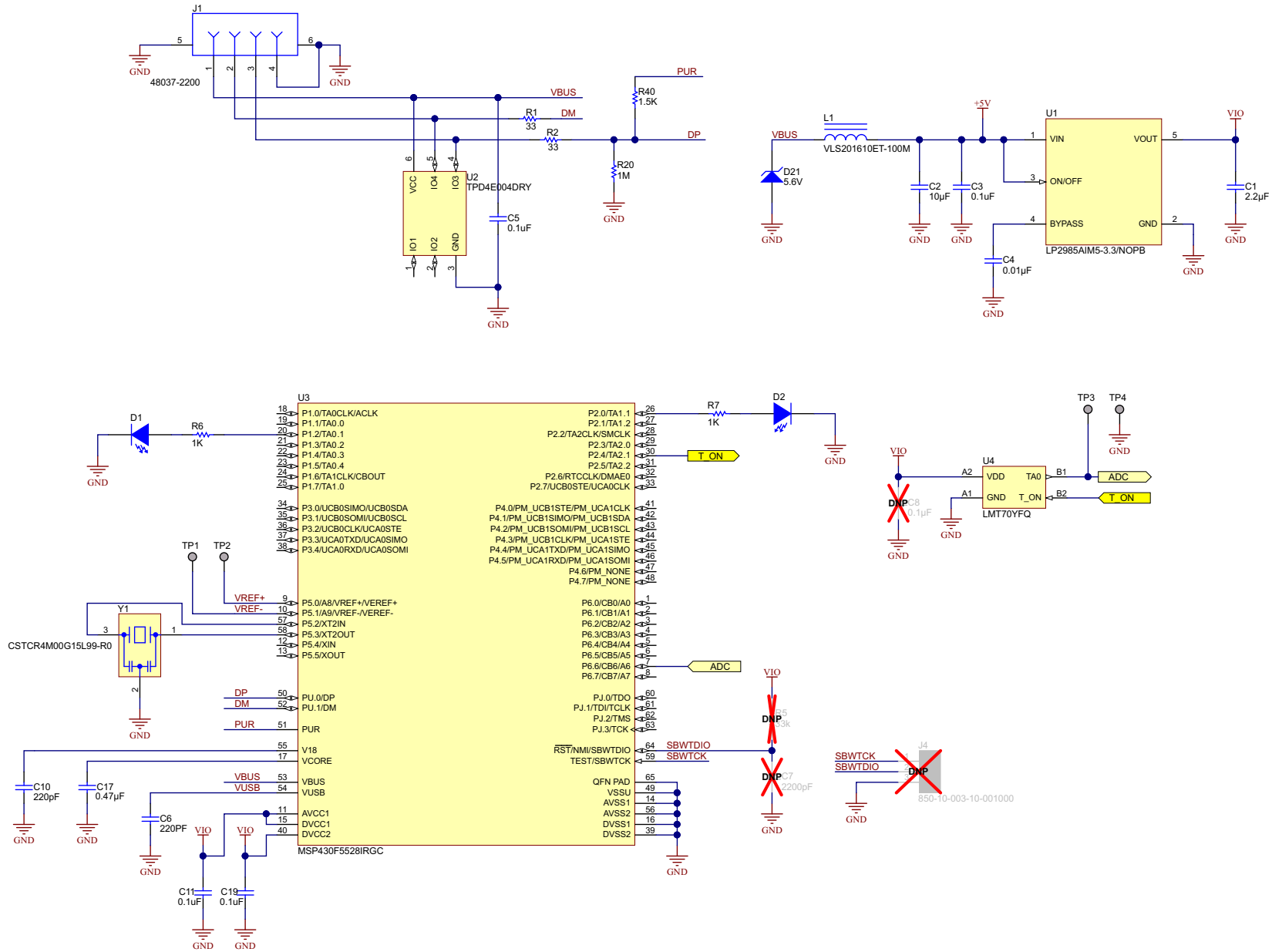

Figure 7-1. LMT70EVM Schematic

Bill of Materials

Designator	Qty	Value	Description	Part Number	Manufacturer
!PCB	1		Printed Circuit Board	SV601095	Any
C1	1	2.2uF	CAP, CERM, 2.2uF, 10V, +/-10%, X5R, 0603	C0603C225K8PACTU	Kemet
C2	1	10uF	CAP, CERM, 10 uF, 10 V, +/- 20%, X5R, 0603	C1608X5R1A106M	TDK
C3, C5, C11, C19	4	0.1uF	CAP CER 0.1UF 16V 5% X7R 0402	GRM155R71C104JA88D	Murata Electronics North America
C4	1	0.01uF	CAP, CERM, 0.01uF, 25V, +/-5%, C0G/NP0, 0603	C1608C0G1E103J	TDK
C6	1	220PF	CAP CER 220PF 50V 1% NP0 0402	C1005C0G1H221F050BA	TDK Corporation
C7	1	2200pF	CAP, CERM, 2200pF, 50V, +/-10%, X7R, 0603	C0603X222K5RACTU	Kemet
C10	1	220pF	CAP, CERM, 220 pF, 50 V, +/- 5%, C0G/NP0, 0402	GRM1555C1H221JA01D	MuRata
C17	1	0.47uF	CAP, CERM, 0.47uF, 10V, +/-10%, X7R, 0603	C0603C474K8RACTU	Kemet
D1	1		LED SMARTLED GREEN 570NM 0603	LG L29K-G2J1-24-Z	OSRAM Opto Semiconductors Inc
D2	1		LED 660NM SUPER RED DIFF 0603SMD	SML-LX0603SRW-TR	Lumex Opto/Components Inc
D21	1	5.6V	Diode, Zener, 5.6V, 500mW, SOD-123	MMSZ5232B-7-F	Diodes Inc.
J1	1		Connector, Plug, USB Type A, R/A, Top Mount SMT	48037-2200	Molex
L1	1	10uH	Inductor, Shielded, Ferrite, 10 uH, 0.4 A, 1.38 ohm, SMD	VLS201610ET-100M	TDK
R1, R2	2	33	RES, 33 ohm, 5%, 0.063W, 0402	CRCW040233R0JNED	Vishay-Dale
R5	1	33k	RES, 33k ohm, 5%, 0.063W, 0402	CRCW040233K0JNED	Vishay-Dale
R6, R7	2	1K	RES 1K OHM 1/10W 5% 0402 SMD	ERJ-2GEJ102X	Panasonic Electronic Components
R20	1	1M	RES,1M ohm, 5%, 0.063W, 0402	RC0402JR-071ML	Yageo
R40	1	1.5K	RES 1.5K OHM 1/16W 5% 0402 SMD	CRCW04021K50JNED	Vishay Dale
U1	1		Micropower 150 mA Low-Noise Ultra Low-Dropout Regulator in SOT-23 Package, DBV0005A	LP2985AIM5-3.3/NOPB	Texas Instruments
U2	1		4-CHANNEL ESD-PROTECTION ARRAY FOR HIGH-SPEED DATA INTERFACES, DRY006A	TPD4E004DRY	Texas Instruments
U3	1		Mixed Signal MicroController, RGC0064B	MSP430F5528IRGC	Texas Instruments
U4	1		Precise Temperature Sensor with Output Enable TEMPERATURE SENSOR, YFQ0004ACAC	LMT70YFQ	Texas Instruments
Y1	1		Resonator, 4MHz, 39pF SMD	CSTCR4M00G15L99-R0	MuRata
C8	0	0.1uF	CAP, CERM, 0.1 uF, 10 V, +/- 10%, X5R, 0201	CL03A104KP3NUNC	Samsung
J4	0		Header, 50mil, 3x1, Gold, TH	850-10-003-10-001000	Mill-Max

Revision History

Changes from A Revision (February 2015) to B Revision Page

- Added Chapter 5: Troubleshooting 16
-

NOTE: Page numbers for previous revisions may differ from page numbers in the current version.

STANDARD TERMS AND CONDITIONS FOR EVALUATION MODULES

1. *Delivery:* TI delivers TI evaluation boards, kits, or modules, including any accompanying demonstration software, components, or documentation (collectively, an "EVM" or "EVMs") to the User ("User") in accordance with the terms and conditions set forth herein. Acceptance of the EVM is expressly subject to the following terms and conditions.
 - 1.1 EVMs are intended solely for product or software developers for use in a research and development setting to facilitate feasibility evaluation, experimentation, or scientific analysis of TI semiconductors products. EVMs have no direct function and are not finished products. EVMs shall not be directly or indirectly assembled as a part or subassembly in any finished product. For clarification, any software or software tools provided with the EVM ("Software") shall not be subject to the terms and conditions set forth herein but rather shall be subject to the applicable terms and conditions that accompany such Software
 - 1.2 EVMs are not intended for consumer or household use. EVMs may not be sold, sublicensed, leased, rented, loaned, assigned, or otherwise distributed for commercial purposes by Users, in whole or in part, or used in any finished product or production system.
2. *Limited Warranty and Related Remedies/Disclaimers:*
 - 2.1 These terms and conditions do not apply to Software. The warranty, if any, for Software is covered in the applicable Software License Agreement.
 - 2.2 TI warrants that the TI EVM will conform to TI's published specifications for ninety (90) days after the date TI delivers such EVM to User. Notwithstanding the foregoing, TI shall not be liable for any defects that are caused by neglect, misuse or mistreatment by an entity other than TI, including improper installation or testing, or for any EVMs that have been altered or modified in any way by an entity other than TI. Moreover, TI shall not be liable for any defects that result from User's design, specifications or instructions for such EVMs. Testing and other quality control techniques are used to the extent TI deems necessary or as mandated by government requirements. TI does not test all parameters of each EVM.
 - 2.3 If any EVM fails to conform to the warranty set forth above, TI's sole liability shall be at its option to repair or replace such EVM, or credit User's account for such EVM. TI's liability under this warranty shall be limited to EVMs that are returned during the warranty period to the address designated by TI and that are determined by TI not to conform to such warranty. If TI elects to repair or replace such EVM, TI shall have a reasonable time to repair such EVM or provide replacements. Repaired EVMs shall be warranted for the remainder of the original warranty period. Replaced EVMs shall be warranted for a new full ninety (90) day warranty period.
3. *Regulatory Notices:*
 - 3.1 *United States*
 - 3.1.1 *Notice applicable to EVMs not FCC-Approved:*

This kit is designed to allow product developers to evaluate electronic components, circuitry, or software associated with the kit to determine whether to incorporate such items in a finished product and software developers to write software applications for use with the end product. This kit is not a finished product and when assembled may not be resold or otherwise marketed unless all required FCC equipment authorizations are first obtained. Operation is subject to the condition that this product not cause harmful interference to licensed radio stations and that this product accept harmful interference. Unless the assembled kit is designed to operate under part 15, part 18 or part 95 of this chapter, the operator of the kit must operate under the authority of an FCC license holder or must secure an experimental authorization under part 5 of this chapter.
 - 3.1.2 *For EVMs annotated as FCC – FEDERAL COMMUNICATIONS COMMISSION Part 15 Compliant:*

CAUTION

This device complies with part 15 of the FCC Rules. Operation is subject to the following two conditions: (1) This device may not cause harmful interference, and (2) this device must accept any interference received, including interference that may cause undesired operation.

Changes or modifications not expressly approved by the party responsible for compliance could void the user's authority to operate the equipment.

FCC Interference Statement for Class A EVM devices

NOTE: This equipment has been tested and found to comply with the limits for a Class A digital device, pursuant to part 15 of the FCC Rules. These limits are designed to provide reasonable protection against harmful interference when the equipment is operated in a commercial environment. This equipment generates, uses, and can radiate radio frequency energy and, if not installed and used in accordance with the instruction manual, may cause harmful interference to radio communications. Operation of this equipment in a residential area is likely to cause harmful interference in which case the user will be required to correct the interference at his own expense.

FCC Interference Statement for Class B EVM devices

NOTE: This equipment has been tested and found to comply with the limits for a Class B digital device, pursuant to part 15 of the FCC Rules. These limits are designed to provide reasonable protection against harmful interference in a residential installation. This equipment generates, uses and can radiate radio frequency energy and, if not installed and used in accordance with the instructions, may cause harmful interference to radio communications. However, there is no guarantee that interference will not occur in a particular installation. If this equipment does cause harmful interference to radio or television reception, which can be determined by turning the equipment off and on, the user is encouraged to try to correct the interference by one or more of the following measures:

- Reorient or relocate the receiving antenna.
- Increase the separation between the equipment and receiver.
- Connect the equipment into an outlet on a circuit different from that to which the receiver is connected.
- Consult the dealer or an experienced radio/TV technician for help.

3.2 Canada

3.2.1 For EVMs issued with an Industry Canada Certificate of Conformance to RSS-210

Concerning EVMs Including Radio Transmitters:

This device complies with Industry Canada license-exempt RSS standard(s). Operation is subject to the following two conditions: (1) this device may not cause interference, and (2) this device must accept any interference, including interference that may cause undesired operation of the device.

Concernant les EVMs avec appareils radio:

Le présent appareil est conforme aux CNR d'Industrie Canada applicables aux appareils radio exempts de licence. L'exploitation est autorisée aux deux conditions suivantes: (1) l'appareil ne doit pas produire de brouillage, et (2) l'utilisateur de l'appareil doit accepter tout brouillage radioélectrique subi, même si le brouillage est susceptible d'en compromettre le fonctionnement.

Concerning EVMs Including Detachable Antennas:

Under Industry Canada regulations, this radio transmitter may only operate using an antenna of a type and maximum (or lesser) gain approved for the transmitter by Industry Canada. To reduce potential radio interference to other users, the antenna type and its gain should be so chosen that the equivalent isotropically radiated power (e.i.r.p.) is not more than that necessary for successful communication. This radio transmitter has been approved by Industry Canada to operate with the antenna types listed in the user guide with the maximum permissible gain and required antenna impedance for each antenna type indicated. Antenna types not included in this list, having a gain greater than the maximum gain indicated for that type, are strictly prohibited for use with this device.

Concernant les EVMs avec antennes détachables

Conformément à la réglementation d'Industrie Canada, le présent émetteur radio peut fonctionner avec une antenne d'un type et d'un gain maximal (ou inférieur) approuvé pour l'émetteur par Industrie Canada. Dans le but de réduire les risques de brouillage radioélectrique à l'intention des autres utilisateurs, il faut choisir le type d'antenne et son gain de sorte que la puissance isotrope rayonnée équivalente (p.i.r.e.) ne dépasse pas l'intensité nécessaire à l'établissement d'une communication satisfaisante. Le présent émetteur radio a été approuvé par Industrie Canada pour fonctionner avec les types d'antenne énumérés dans le manuel d'usage et ayant un gain admissible maximal et l'impédance requise pour chaque type d'antenne. Les types d'antenne non inclus dans cette liste, ou dont le gain est supérieur au gain maximal indiqué, sont strictement interdits pour l'exploitation de l'émetteur.

3.3 Japan

3.3.1 *Notice for EVMs delivered in Japan:* Please see http://www.tij.co.jp/lstds/ti_ja/general/eStore/notice_01.page 日本国内に輸入される評価用キット、ボードについては、次のところをご覧ください。
http://www.tij.co.jp/lstds/ti_ja/general/eStore/notice_01.page

3.3.2 *Notice for Users of EVMs Considered "Radio Frequency Products" in Japan:* EVMs entering Japan may not be certified by TI as conforming to Technical Regulations of Radio Law of Japan.

If User uses EVMs in Japan, not certified to Technical Regulations of Radio Law of Japan, User is required by Radio Law of Japan to follow the instructions below with respect to EVMs:

1. Use EVMs in a shielded room or any other test facility as defined in the notification #173 issued by Ministry of Internal Affairs and Communications on March 28, 2006, based on Sub-section 1.1 of Article 6 of the Ministry's Rule for Enforcement of Radio Law of Japan,
2. Use EVMs only after User obtains the license of Test Radio Station as provided in Radio Law of Japan with respect to EVMs, or
3. Use of EVMs only after User obtains the Technical Regulations Conformity Certification as provided in Radio Law of Japan with respect to EVMs. Also, do not transfer EVMs, unless User gives the same notice above to the transferee. Please note that if User does not follow the instructions above, User will be subject to penalties of Radio Law of Japan.

【無線電波を送信する製品の開発キットをお使いになる際の注意事項】 開発キットの中には技術基準適合証明を受けていないものがあります。技術適合証明を受けていないものご使用に際しては、電波法遵守のため、以下のいずれかの措置を取っていただく必要がありますのでご注意ください。

1. 電波法施行規則第6条第1項第1号に基づく平成18年3月28日総務省告示第173号で定められた電波暗室等の試験設備でご使用いただく。
2. 実験局の免許を取得後ご使用いただく。
3. 技術基準適合証明を取得後ご使用いただく。

なお、本製品は、上記の「ご使用にあたっての注意」を譲渡先、移転先に通知しない限り、譲渡、移転できないものとします。

上記を遵守頂けない場合は、電波法の罰則が適用される可能性があることをご留意ください。日本テキサス・インスツルメンツ株式会社

東京都新宿区西新宿 6 丁目 2 4 番 1 号

西新宿三井ビル

3.3.3 *Notice for EVMs for Power Line Communication:* Please see http://www.tij.co.jp/llds/ti_ja/general/eStore/notice_02.page

電力線搬送波通信についての開発キットをお使いになる際の注意事項については、次のところをご覧ください。http://www.tij.co.jp/llds/ti_ja/general/eStore/notice_02.page

4 *EVM Use Restrictions and Warnings:*

4.1 EVMS ARE NOT FOR USE IN FUNCTIONAL SAFETY AND/OR SAFETY CRITICAL EVALUATIONS, INCLUDING BUT NOT LIMITED TO EVALUATIONS OF LIFE SUPPORT APPLICATIONS.

4.2 User must read and apply the user guide and other available documentation provided by TI regarding the EVM prior to handling or using the EVM, including without limitation any warning or restriction notices. The notices contain important safety information related to, for example, temperatures and voltages.

4.3 *Safety-Related Warnings and Restrictions:*

4.3.1 User shall operate the EVM within TI's recommended specifications and environmental considerations stated in the user guide, other available documentation provided by TI, and any other applicable requirements and employ reasonable and customary safeguards. Exceeding the specified performance ratings and specifications (including but not limited to input and output voltage, current, power, and environmental ranges) for the EVM may cause personal injury or death, or property damage. If there are questions concerning performance ratings and specifications, User should contact a TI field representative prior to connecting interface electronics including input power and intended loads. Any loads applied outside of the specified output range may also result in unintended and/or inaccurate operation and/or possible permanent damage to the EVM and/or interface electronics. Please consult the EVM user guide prior to connecting any load to the EVM output. If there is uncertainty as to the load specification, please contact a TI field representative. During normal operation, even with the inputs and outputs kept within the specified allowable ranges, some circuit components may have elevated case temperatures. These components include but are not limited to linear regulators, switching transistors, pass transistors, current sense resistors, and heat sinks, which can be identified using the information in the associated documentation. When working with the EVM, please be aware that the EVM may become very warm.

4.3.2 EVMs are intended solely for use by technically qualified, professional electronics experts who are familiar with the dangers and application risks associated with handling electrical mechanical components, systems, and subsystems. User assumes all responsibility and liability for proper and safe handling and use of the EVM by User or its employees, affiliates, contractors or designees. User assumes all responsibility and liability to ensure that any interfaces (electronic and/or mechanical) between the EVM and any human body are designed with suitable isolation and means to safely limit accessible leakage currents to minimize the risk of electrical shock hazard. User assumes all responsibility and liability for any improper or unsafe handling or use of the EVM by User or its employees, affiliates, contractors or designees.

4.4 User assumes all responsibility and liability to determine whether the EVM is subject to any applicable international, federal, state, or local laws and regulations related to User's handling and use of the EVM and, if applicable, User assumes all responsibility and liability for compliance in all respects with such laws and regulations. User assumes all responsibility and liability for proper disposal and recycling of the EVM consistent with all applicable international, federal, state, and local requirements.

5. *Accuracy of Information:* To the extent TI provides information on the availability and function of EVMs, TI attempts to be as accurate as possible. However, TI does not warrant the accuracy of EVM descriptions, EVM availability or other information on its websites as accurate, complete, reliable, current, or error-free.

6. *Disclaimers:*
- 6.1 EXCEPT AS SET FORTH ABOVE, EVMS AND ANY WRITTEN DESIGN MATERIALS PROVIDED WITH THE EVM (AND THE DESIGN OF THE EVM ITSELF) ARE PROVIDED "AS IS" AND "WITH ALL FAULTS." TI DISCLAIMS ALL OTHER WARRANTIES, EXPRESS OR IMPLIED, REGARDING SUCH ITEMS, INCLUDING BUT NOT LIMITED TO ANY IMPLIED WARRANTIES OF MERCHANTABILITY OR FITNESS FOR A PARTICULAR PURPOSE OR NON-INFRINGEMENT OF ANY THIRD PARTY PATENTS, COPYRIGHTS, TRADE SECRETS OR OTHER INTELLECTUAL PROPERTY RIGHTS.
- 6.2 EXCEPT FOR THE LIMITED RIGHT TO USE THE EVM SET FORTH HEREIN, NOTHING IN THESE TERMS AND CONDITIONS SHALL BE CONSTRUED AS GRANTING OR CONFERRING ANY RIGHTS BY LICENSE, PATENT, OR ANY OTHER INDUSTRIAL OR INTELLECTUAL PROPERTY RIGHT OF TI, ITS SUPPLIERS/LICENSORS OR ANY OTHER THIRD PARTY, TO USE THE EVM IN ANY FINISHED END-USER OR READY-TO-USE FINAL PRODUCT, OR FOR ANY INVENTION, DISCOVERY OR IMPROVEMENT MADE, CONCEIVED OR ACQUIRED PRIOR TO OR AFTER DELIVERY OF THE EVM.
7. *USER'S INDEMNITY OBLIGATIONS AND REPRESENTATIONS.* USER WILL DEFEND, INDEMNIFY AND HOLD TI, ITS LICENSORS AND THEIR REPRESENTATIVES HARMLESS FROM AND AGAINST ANY AND ALL CLAIMS, DAMAGES, LOSSES, EXPENSES, COSTS AND LIABILITIES (COLLECTIVELY, "CLAIMS") ARISING OUT OF OR IN CONNECTION WITH ANY HANDLING OR USE OF THE EVM THAT IS NOT IN ACCORDANCE WITH THESE TERMS AND CONDITIONS. THIS OBLIGATION SHALL APPLY WHETHER CLAIMS ARISE UNDER STATUTE, REGULATION, OR THE LAW OF TORT, CONTRACT OR ANY OTHER LEGAL THEORY, AND EVEN IF THE EVM FAILS TO PERFORM AS DESCRIBED OR EXPECTED.
8. *Limitations on Damages and Liability:*
- 8.1 *General Limitations.* IN NO EVENT SHALL TI BE LIABLE FOR ANY SPECIAL, COLLATERAL, INDIRECT, PUNITIVE, INCIDENTAL, CONSEQUENTIAL, OR EXEMPLARY DAMAGES IN CONNECTION WITH OR ARISING OUT OF THESE TERMS AND CONDITIONS OR THE USE OF THE EVMS PROVIDED HEREUNDER, REGARDLESS OF WHETHER TI HAS BEEN ADVISED OF THE POSSIBILITY OF SUCH DAMAGES. EXCLUDED DAMAGES INCLUDE, BUT ARE NOT LIMITED TO, COST OF REMOVAL OR REINSTALLATION, ANCILLARY COSTS TO THE PROCUREMENT OF SUBSTITUTE GOODS OR SERVICES, RETESTING, OUTSIDE COMPUTER TIME, LABOR COSTS, LOSS OF GOODWILL, LOSS OF PROFITS, LOSS OF SAVINGS, LOSS OF USE, LOSS OF DATA, OR BUSINESS INTERRUPTION. NO CLAIM, SUIT OR ACTION SHALL BE BROUGHT AGAINST TI MORE THAN ONE YEAR AFTER THE RELATED CAUSE OF ACTION HAS OCCURRED.
- 8.2 *Specific Limitations.* IN NO EVENT SHALL TI'S AGGREGATE LIABILITY FROM ANY WARRANTY OR OTHER OBLIGATION ARISING OUT OF OR IN CONNECTION WITH THESE TERMS AND CONDITIONS, OR ANY USE OF ANY TI EVM PROVIDED HEREUNDER, EXCEED THE TOTAL AMOUNT PAID TO TI FOR THE PARTICULAR UNITS SOLD UNDER THESE TERMS AND CONDITIONS WITH RESPECT TO WHICH LOSSES OR DAMAGES ARE CLAIMED. THE EXISTENCE OF MORE THAN ONE CLAIM AGAINST THE PARTICULAR UNITS SOLD TO USER UNDER THESE TERMS AND CONDITIONS SHALL NOT ENLARGE OR EXTEND THIS LIMIT.
9. *Return Policy.* Except as otherwise provided, TI does not offer any refunds, returns, or exchanges. Furthermore, no return of EVM(s) will be accepted if the package has been opened and no return of the EVM(s) will be accepted if they are damaged or otherwise not in a resalable condition. If User feels it has been incorrectly charged for the EVM(s) it ordered or that delivery violates the applicable order, User should contact TI. All refunds will be made in full within thirty (30) working days from the return of the components(s), excluding any postage or packaging costs.
10. *Governing Law:* These terms and conditions shall be governed by and interpreted in accordance with the laws of the State of Texas, without reference to conflict-of-laws principles. User agrees that non-exclusive jurisdiction for any dispute arising out of or relating to these terms and conditions lies within courts located in the State of Texas and consents to venue in Dallas County, Texas. Notwithstanding the foregoing, any judgment may be enforced in any United States or foreign court, and TI may seek injunctive relief in any United States or foreign court.

Mailing Address: Texas Instruments, Post Office Box 655303, Dallas, Texas 75265
Copyright © 2015, Texas Instruments Incorporated

IMPORTANT NOTICE

Texas Instruments Incorporated and its subsidiaries (TI) reserve the right to make corrections, enhancements, improvements and other changes to its semiconductor products and services per JESD46, latest issue, and to discontinue any product or service per JESD48, latest issue. Buyers should obtain the latest relevant information before placing orders and should verify that such information is current and complete. All semiconductor products (also referred to herein as "components") are sold subject to TI's terms and conditions of sale supplied at the time of order acknowledgment.

TI warrants performance of its components to the specifications applicable at the time of sale, in accordance with the warranty in TI's terms and conditions of sale of semiconductor products. Testing and other quality control techniques are used to the extent TI deems necessary to support this warranty. Except where mandated by applicable law, testing of all parameters of each component is not necessarily performed.

TI assumes no liability for applications assistance or the design of Buyers' products. Buyers are responsible for their products and applications using TI components. To minimize the risks associated with Buyers' products and applications, Buyers should provide adequate design and operating safeguards.

TI does not warrant or represent that any license, either express or implied, is granted under any patent right, copyright, mask work right, or other intellectual property right relating to any combination, machine, or process in which TI components or services are used. Information published by TI regarding third-party products or services does not constitute a license to use such products or services or a warranty or endorsement thereof. Use of such information may require a license from a third party under the patents or other intellectual property of the third party, or a license from TI under the patents or other intellectual property of TI.

Reproduction of significant portions of TI information in TI data books or data sheets is permissible only if reproduction is without alteration and is accompanied by all associated warranties, conditions, limitations, and notices. TI is not responsible or liable for such altered documentation. Information of third parties may be subject to additional restrictions.

Resale of TI components or services with statements different from or beyond the parameters stated by TI for that component or service voids all express and any implied warranties for the associated TI component or service and is an unfair and deceptive business practice. TI is not responsible or liable for any such statements.

Buyer acknowledges and agrees that it is solely responsible for compliance with all legal, regulatory and safety-related requirements concerning its products, and any use of TI components in its applications, notwithstanding any applications-related information or support that may be provided by TI. Buyer represents and agrees that it has all the necessary expertise to create and implement safeguards which anticipate dangerous consequences of failures, monitor failures and their consequences, lessen the likelihood of failures that might cause harm and take appropriate remedial actions. Buyer will fully indemnify TI and its representatives against any damages arising out of the use of any TI components in safety-critical applications.

In some cases, TI components may be promoted specifically to facilitate safety-related applications. With such components, TI's goal is to help enable customers to design and create their own end-product solutions that meet applicable functional safety standards and requirements. Nonetheless, such components are subject to these terms.

No TI components are authorized for use in FDA Class III (or similar life-critical medical equipment) unless authorized officers of the parties have executed a special agreement specifically governing such use.

Only those TI components which TI has specifically designated as military grade or "enhanced plastic" are designed and intended for use in military/aerospace applications or environments. Buyer acknowledges and agrees that any military or aerospace use of TI components which have **not** been so designated is solely at the Buyer's risk, and that Buyer is solely responsible for compliance with all legal and regulatory requirements in connection with such use.

TI has specifically designated certain components as meeting ISO/TS16949 requirements, mainly for automotive use. In any case of use of non-designated products, TI will not be responsible for any failure to meet ISO/TS16949.

Products

Audio	www.ti.com/audio
Amplifiers	amplifier.ti.com
Data Converters	dataconverter.ti.com
DLP® Products	www.dlp.com
DSP	dsp.ti.com
Clocks and Timers	www.ti.com/clocks
Interface	interface.ti.com
Logic	logic.ti.com
Power Mgmt	power.ti.com
Microcontrollers	microcontroller.ti.com
RFID	www.ti-rfid.com
OMAP Applications Processors	www.ti.com/omap
Wireless Connectivity	www.ti.com/wirelessconnectivity

Applications

Automotive and Transportation	www.ti.com/automotive
Communications and Telecom	www.ti.com/communications
Computers and Peripherals	www.ti.com/computers
Consumer Electronics	www.ti.com/consumer-apps
Energy and Lighting	www.ti.com/energy
Industrial	www.ti.com/industrial
Medical	www.ti.com/medical
Security	www.ti.com/security
Space, Avionics and Defense	www.ti.com/space-avionics-defense
Video and Imaging	www.ti.com/video

TI E2E Community

e2e.ti.com