

# Normal Mode for Signal Line, Through-Hole Type, Bead Winding Type Series

## Overview

The KEMET winding type beads intended for normal mode noise suppression have a wide variety of characteristics. These through-hole beads are designed with our proprietary ferrite material and are suitable for noise countermeasure in DC signal line circuits.

## Applications

- Audio-visual equipment
- Office automation equipment
- Digital appliances
- Home appliances
- Power supplies

## Benefits

- Proprietary Manganese-Zinc (Mn-Zn) and Nickel-Zinc (Ni-Zn) ferrite materials (except B-6-\*\*\*)
- Operating temperature range from -25°C to +65°C (except B-6-\*\*\*: -20°C to +60°C)
- RoHS Compliant



## Part Number System

B-	6-	1	
Series	Core Shape	Internal Management Code	
Bead	Blank = Toroidal 6 = Square 6 holes	1 3 4 5 6-22B	6-31B 7 8 9 10 13

## Dimensions – Millimeters

Clock pulse oscillating section

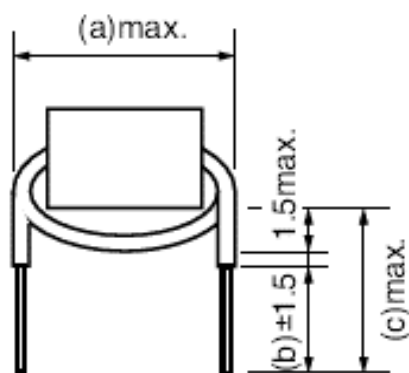
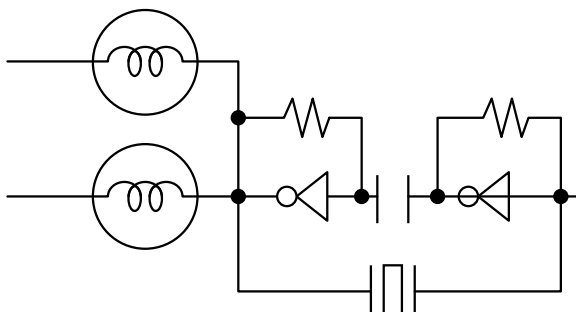

Part Number	Dimensions - Millimeters		
	a Maximum	b ±1.5	c Maximum
B-1	5.5	5.0	9.0
B-3	9.0	5.0	10.0
B-4	10.5	5.0	9.0
B-5	11.0	5.0	9.0
B-7	6.0	5.0	9.0

## Dimensions – Millimeters cont.

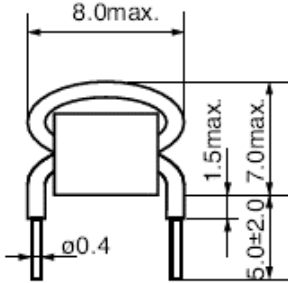
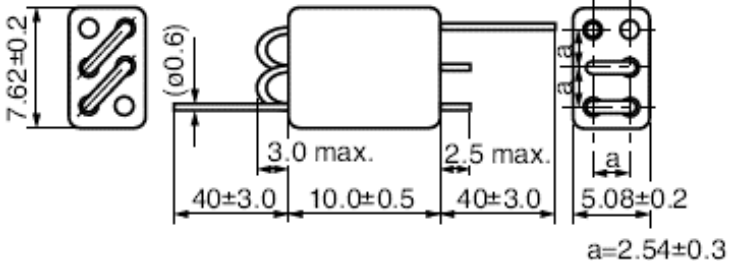
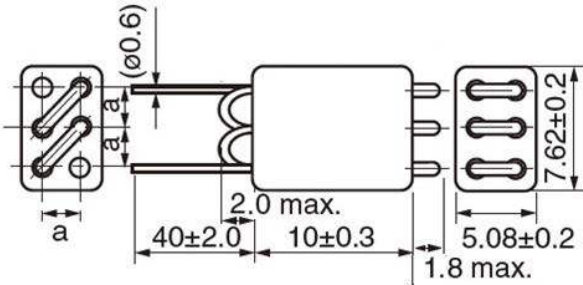
Part Number	Dimensions - Millimeters
B-8 B-9 B-10	
B-6-22B	
B-6-31B	

## Environmental Compliance

All KEMET DC line filters are RoHS Compliant.



## Performance Characteristics

Item	Performance Characteristics
Rated Current Range	1.5 – 3.5 A
Wire	Teflon and soft copper
Number of Turns	2 – 5
Operating Temperature	-25°C to +65°C (not including self-temperature rise) except B-6-***: -20°C to +60°C (not including self-temperature rise)

**Table 1 – Ratings & Part Number Reference**

Part Number	Rated Current DC <sup>1</sup> (A)	Core	Wire	Number of Turns	Weight (g)
B-1	1.5	B-20F-28	Teflon Wire (φ 0.26: Single) Color: White	2T	0.09
B-3	3.5	B-20L-48B	Teflon Wire (φ 0.51: Single) Color: Red	2T	0.44
B-4	1.5	B-20L-44	Teflon Wire (φ 0.26: Single) Color: White	2T	0.48
B-5	1.5	B-20L-44	Teflon Wire (φ 0.26: Single) Color: White	3T	0.50
B-7	2.5	B-20F-28	Teflon Wire (φ 0.32: Single) Color: Green	2T	0.09
B-8	2.5	B-20L-48B	Teflon Wire (φ 0.40: Single) Color: Blue	2T	0.37
B-9	2.5	B-20L-48B	Teflon Wire (φ 0.40: Single) Color: Yellow	3T	0.41
B-10	2.5	B-20L-48B	Teflon Wire (φ 0.40: Single) Color: Black	4T	0.43
B-13	2.5	B-20L-48B	Teflon Wire (φ 0.40: Single) Color: White	5T	0.50
B-6-22B	2.0	-	Soft Copper Wire (φ 0.6)	-	2.18
B-6-31B	2.0	-	Soft Copper Wire (φ 0.6)	-	2.20

<sup>1</sup> Rated current values are not guaranteed by impedance levels; these values are permissible levels when the lead wire temperature rise is 20°C.

## Frequency Characteristics

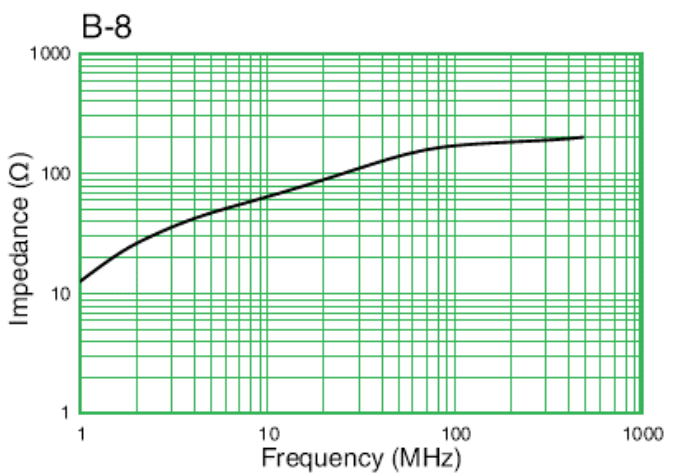
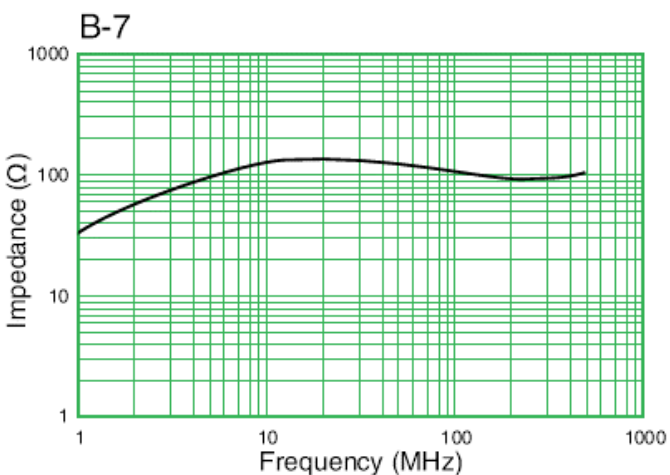
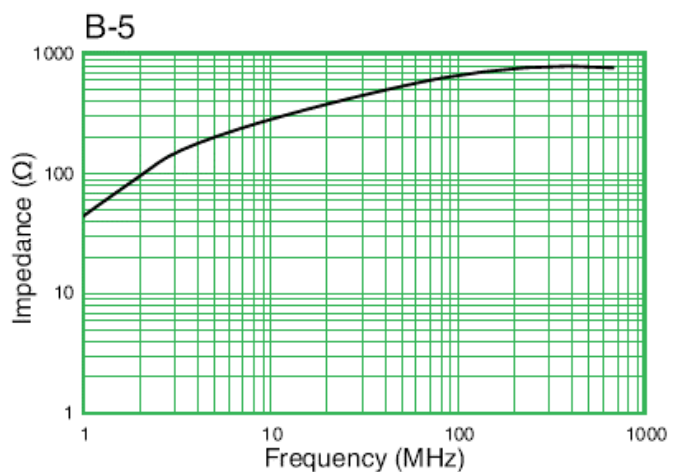
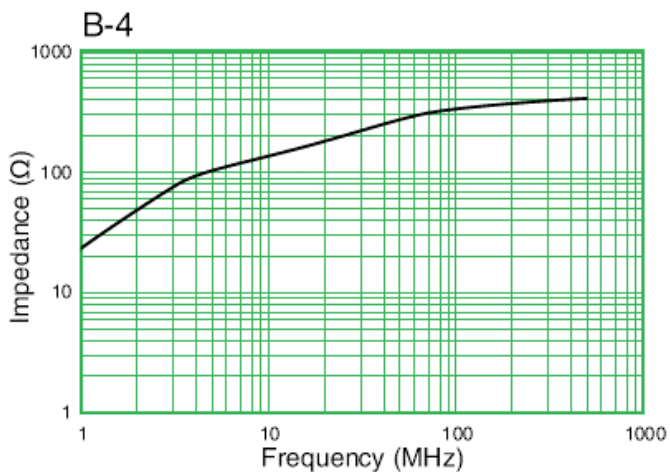
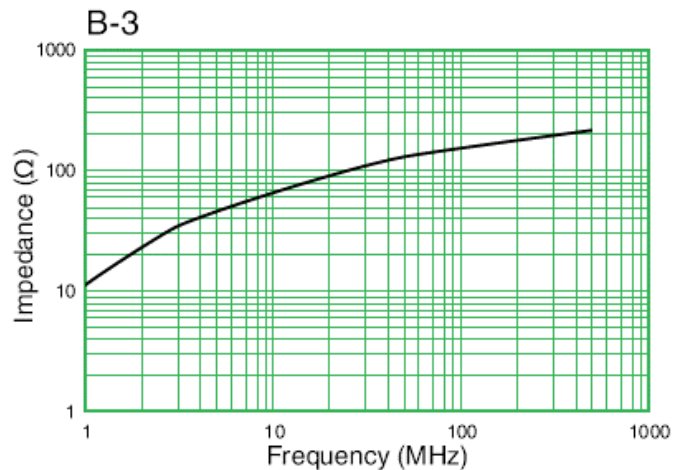
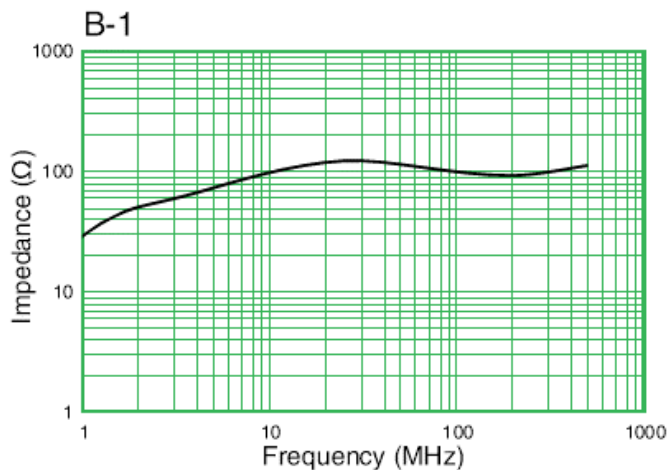

## Frequency Characteristics cont.

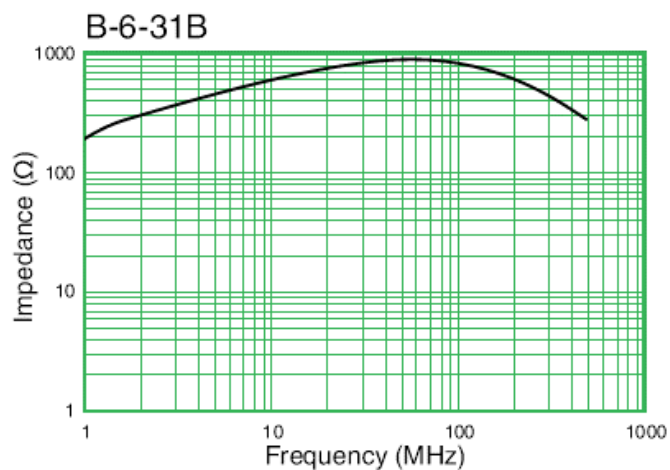
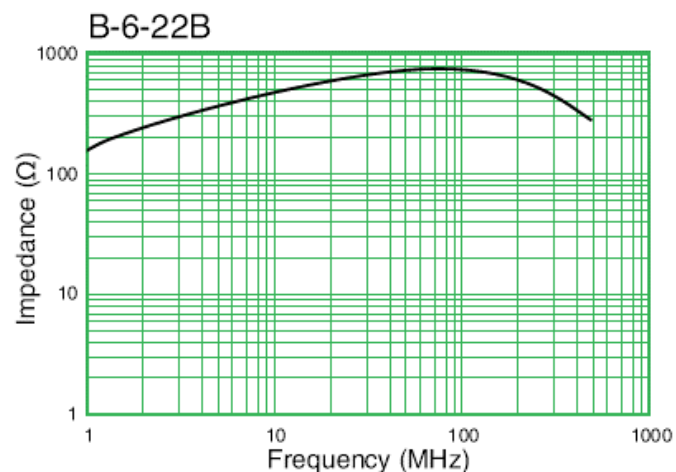
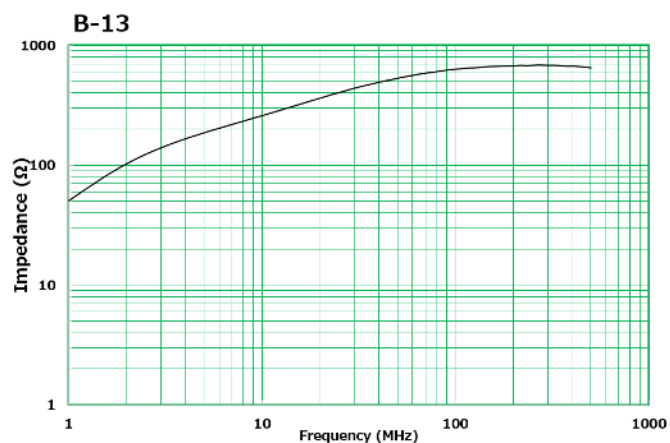
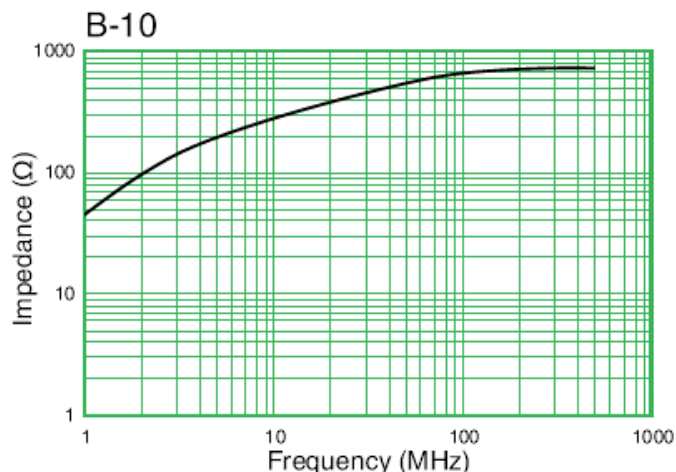
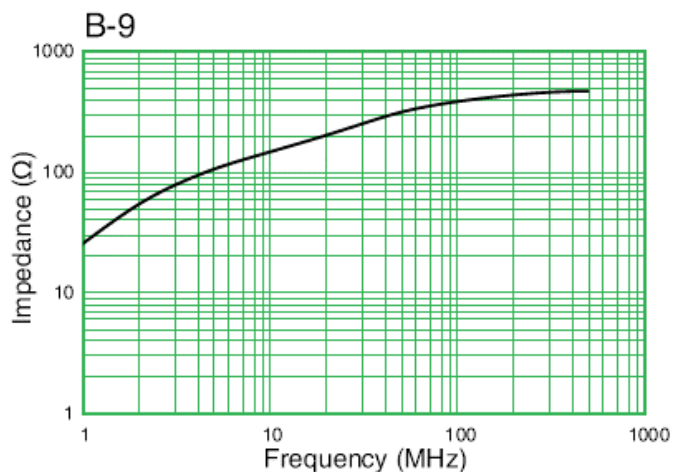

## Packaging

Part Type	Packaging Type	Pieces per Package	Pieces per Box
B-1	Tray	4,000	24,000
B-3			
B-4			
B-5			
B-7			
B-8			
B-9			
B-10			
B-13			
B-6-22B			
B-6-31B	500	3,000	

## Handling Precautions

### Precautions for product storage

DC Line Filters should be stored in normal working environments. While the chokes themselves are quite robust in other environments, solderability will be degraded by exposure to high temperatures, high humidity, corrosive atmospheres, and long term storage.

KEMET recommends that maximum storage temperature not exceed 40°C and maximum storage humidity not exceed 70% relative humidity. Atmospheres should be free of chlorine and sulfur bearing compounds. Temperature fluctuations should be minimized to avoid condensation on the parts. Do not store near strong magnetic fields, as this might magnetize the product.

For optimized solderability, DC line filter stock should be used promptly, preferably within six months of receipt.

### Product temperature rise values

The values listed for temperature rise are the result of self-heating in wires when the rated current (commercial frequency) is applied. When using, check and evaluate the value of the core temperature rise under actual operating conditions.

## Export Control

### For customers in Japan

For products that are controlled items subject to the “Foreign Exchange and Foreign Trade Law” of Japan, the export license specified by the law is required for export.

### For customers outside Japan

DC Line Filters should not be used or sold for use in the development, production, stockpiling or utilization of any conventional weapons or mass-destructive weapons (nuclear weapons, chemical or biological weapons, or missiles) or any other weapons.

## KEMET Electronics Corporation Sales Offices

For a complete list of our global sales offices, please visit [www.kemet.com/sales](http://www.kemet.com/sales).

---

## Disclaimer

All product specifications, statements, information and data (collectively, the "Information") in this datasheet are subject to change. The customer is responsible for checking and verifying the extent to which the Information contained in this publication is applicable to an order at the time the order is placed. All Information given herein is believed to be accurate and reliable, but it is presented without guarantee, warranty, or responsibility of any kind, expressed or implied.

Statements of suitability for certain applications are based on KEMET Electronics Corporation's ("KEMET") knowledge of typical operating conditions for such applications, but are not intended to constitute – and KEMET specifically disclaims – any warranty concerning suitability for a specific customer application or use. The Information is intended for use only by customers who have the requisite experience and capability to determine the correct products for their application. Any technical advice inferred from this Information or otherwise provided by KEMET with reference to the use of KEMET's products is given gratis, and KEMET assumes no obligation or liability for the advice given or results obtained.

Although KEMET designs and manufactures its products to the most stringent quality and safety standards, given the current state of the art, isolated component failures may still occur. Accordingly, customer applications which require a high degree of reliability or safety should employ suitable designs or other safeguards (such as installation of protective circuitry or redundancies) in order to ensure that the failure of an electrical component does not result in a risk of personal injury or property damage.

Although all product-related warnings, cautions and notes must be observed, the customer should not assume that all safety measures are indicated or that other measures may not be required.

When providing KEMET products and technologies contained herein to other countries, the customer must abide by the procedures and provisions stipulated in all applicable export laws and regulations, including without limitation the International Traffic in Arms Regulations (ITAR), the US Export Administration Regulations (EAR) and the Japan Foreign Exchange and Foreign Trade Act.

*KEMET is a registered trademark of KEMET Electronics Corporation.*