

Peak Emission Wavelength: 275nm

The MTSM275UV-F1120 is a deep ultraviolet light emitting diode with peak emission wavelengths from 270nm to 280nm. The LED is sealed in a ceramic package with UV stable encapsulation. It incorporates state of the art surface mount device (SMD) design and low thermal resistance.

FEATURES

- > Deep ultraviolet LED
- > Low thermal resistance
- > SMT solderable

APPLICATIONS

- > Disinfection
- > Fluorescent spectroscopy
- > Chemical and Biological Analysis

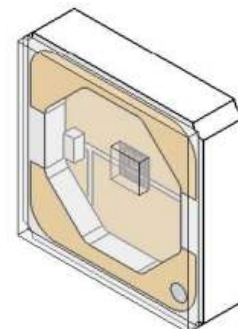

Absolute Maximum Ratings (Ta=25°C)



ITEMS	SYMBOL	RATINGS	UNIT
Forward Current	If	30	mA
Power Dissipation	Pd	210	mW
Reverse Voltage	Vr	6	V
Storage Temperature	Tstg	100	°C

Note: Also available on PCB - Star Board MTSM275UV-F1120S

Electrical & Optical Characteristics (Ta = 25°C)

ITEMS	SYMBOL	CONDITION	MINIMUM	MAXIMUM	UNIT
Peak Wavelength [1]	λ_p	IF=20mA	270	280	nm
Power Output [2]	Po [3]	IF=20mA	1.0	2.0	mW
Forward Voltage [4]	Vf	IF=20mA	5.0	7.0	V
FWHM	$\Delta\lambda$	IF=20mA	9.0	15.0	nm
Viewing Angle	$2\Theta_{1/2}$	IF=20mA	125 +/-5		deg
Thermal Resistance (Tj-Tsp)	Rth	--	20		°C/W

Ta=25 °C, with external heat sink Rth (sp-a) [5] ≤ 20 °C/W, Forward Current=20mA, 20% RH 70%-range

Notes:

- [1] Peak wavelength measurement tolerance is ± 2 nm
- [2] Optical power output measurement tolerance is ± 10%
- [3] Popt is the Output Optical Power as measured with a radiometer with an integrated sphere
- [4] Forward voltage measurement tolerance is ± 2%
- [5] Rth(sp-a) defined as thermal resistance from solder point to ambient
- [6] The exposure to the absolute maximum rated conditions may affect device reliability

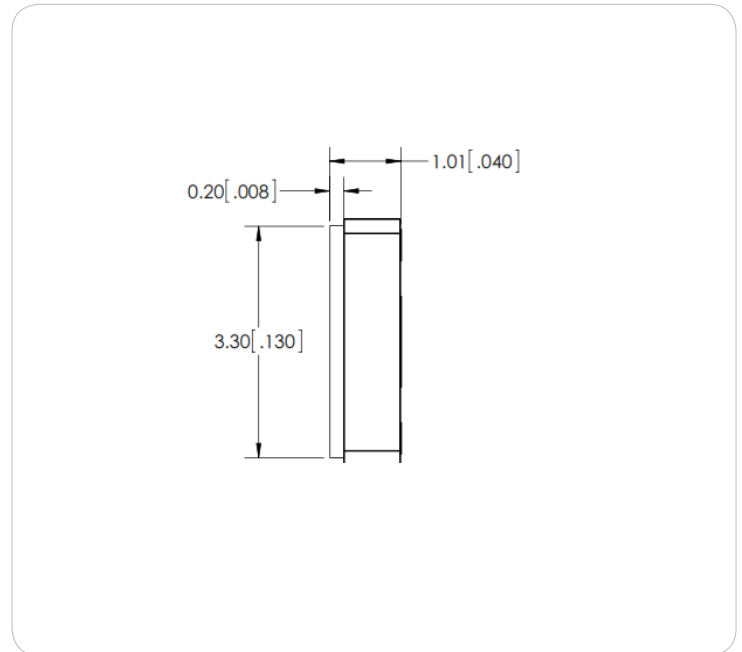
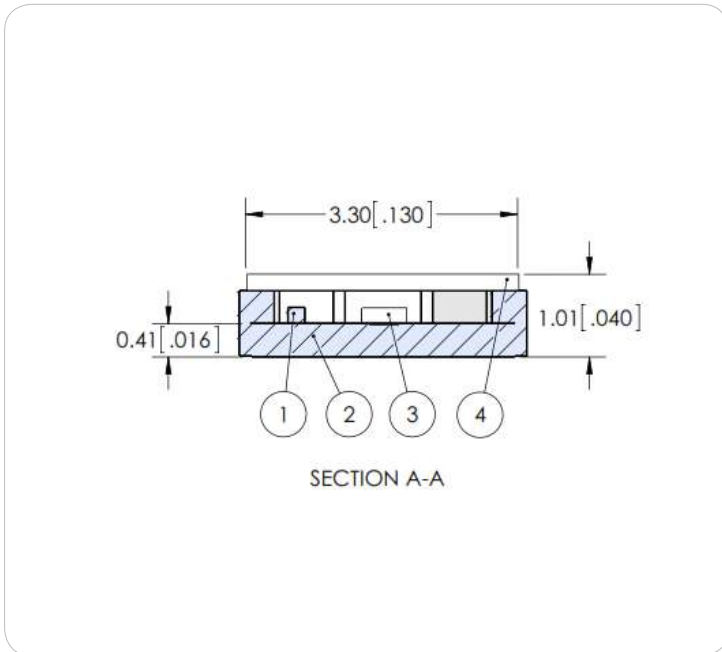
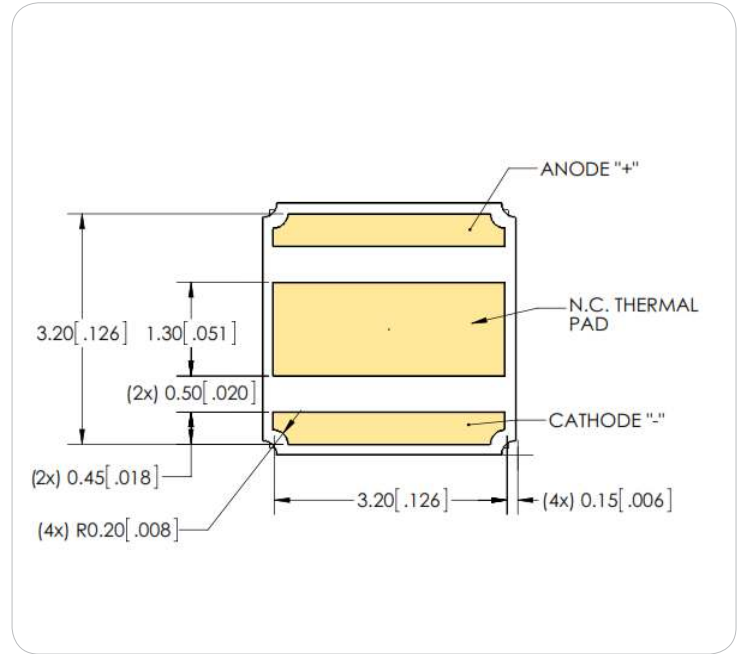
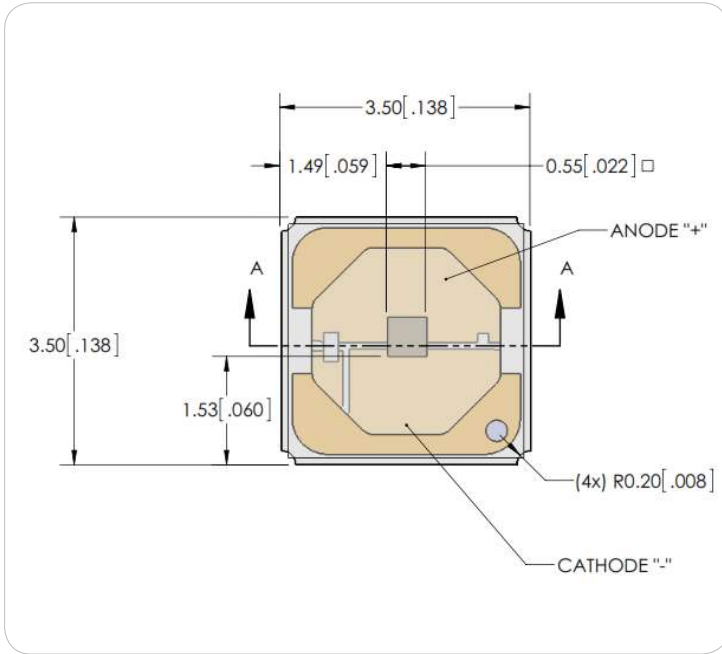

Notes:

- [1] All dimensions in millimeters [inches]
- [2] Drawings not to scale
- [3] All dimensions are for reference only

Material Information	
PKG Body	Ceramic
Lens	Fused Silica

$T_a = 25\text{ }^\circ\text{C}$, RH=30%

1. Relative Spectral Power Distribution

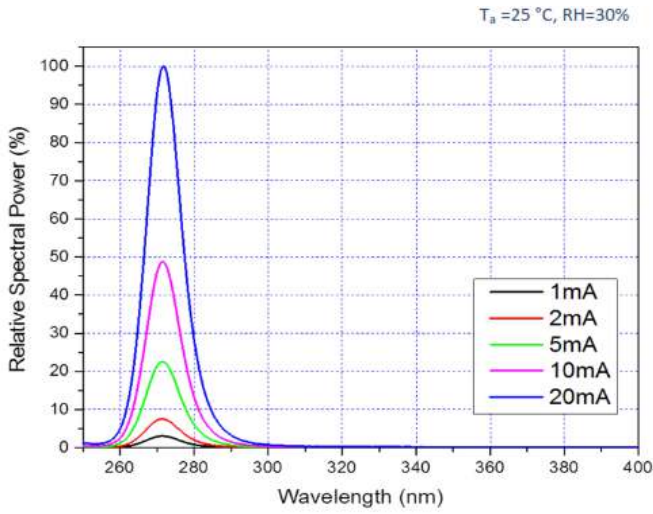

2. Forward Current vs. Forward Voltage

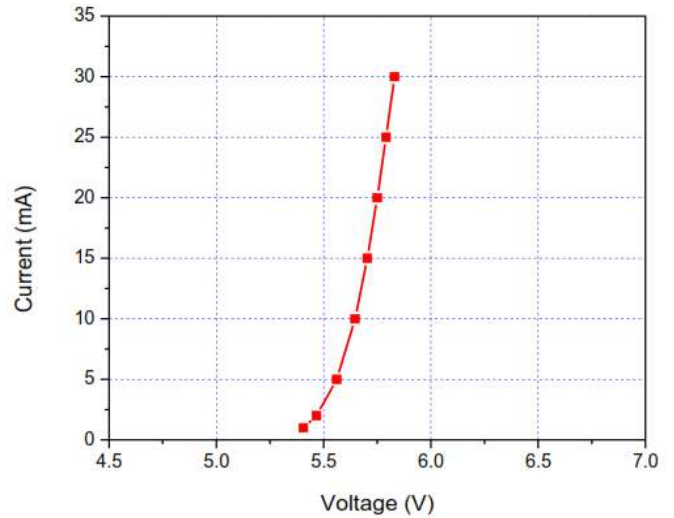

3. Relative Radiant Flux vs. Forward Current

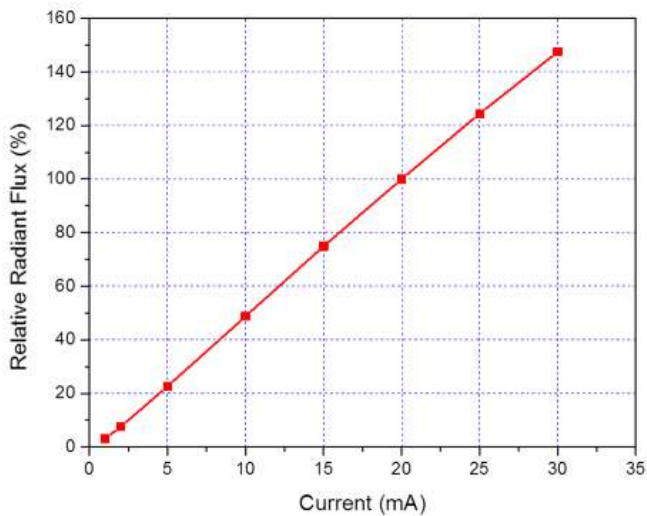

4. Peak Wavelength vs. Forward Current

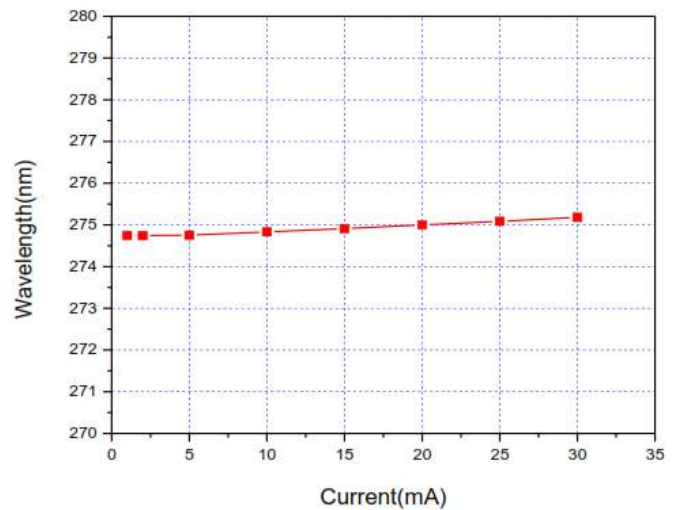

$I_f = 20\text{mA}$

5. Relative Radiant Flux vs. Ambient Temperature

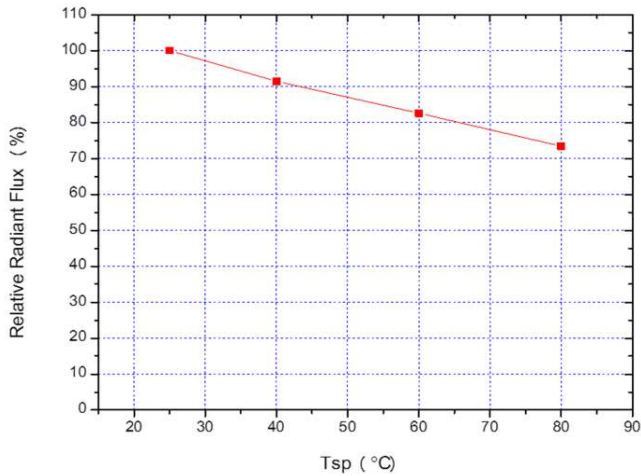

6. Peak Wavelength vs. Ambient Temperature

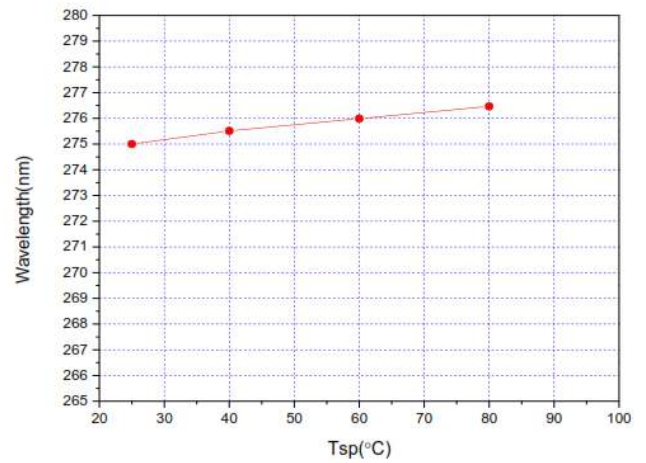

7. Forward Voltage vs. Ambient Temperature

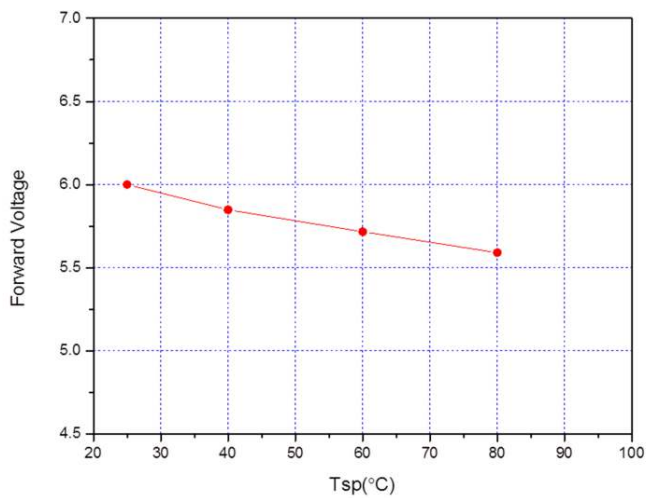

8. Typical Radiant Diagram

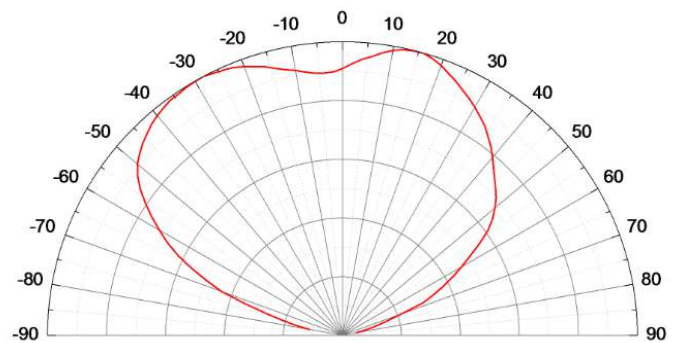

Recommended Solder Pad

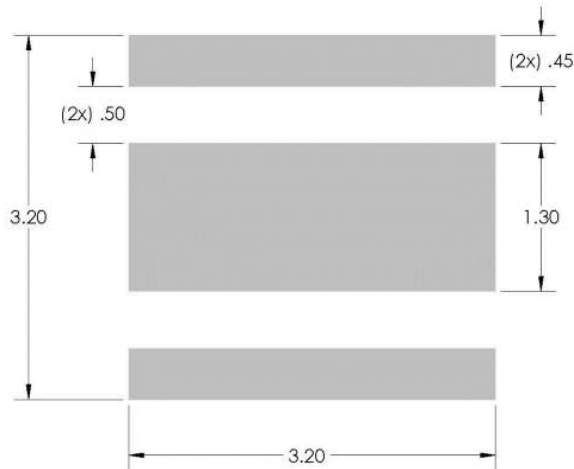

Notes:

- [1] All dimensions in millimeters
- [2] Drawings not to scale
- [3] All dimensions are for reference only



CAUTION

1. LEDs emit very strong UV radiation during operation.
2. Don't look directly into the LED light when in operation as UV radiation can harm your eyes.
3. To prevent even inadequate exposure, wear protective eyewear.
4. If LEDs are embedded in devices, please indicate warning labels against the UV LED used.
5. Avoid prolonged exposure to skin or other tissue during operation.
6. Keep out of reach of children.
7. Take appropriate precautions around pets and other living organisms to avoid UV exposure.
8. Specification and dimension are subject to change without notice.

UVTOP® SMD Soldering Conditions and Handling

UVTOP® SMD LEDs reflow characteristics are compatible with JEDEC J-STD-020C . It is generally recommended to follow the solder profile provided by the manufacturer of the solder paste used. These profiles are suggested as a guideline and may require adjustment depending on the users application.

It is recommended to verify the solder process through reflow of several test PCBs and subsequent X-ray or shear testing of the devices. The solder should show minimum indication of voids or solder grains.

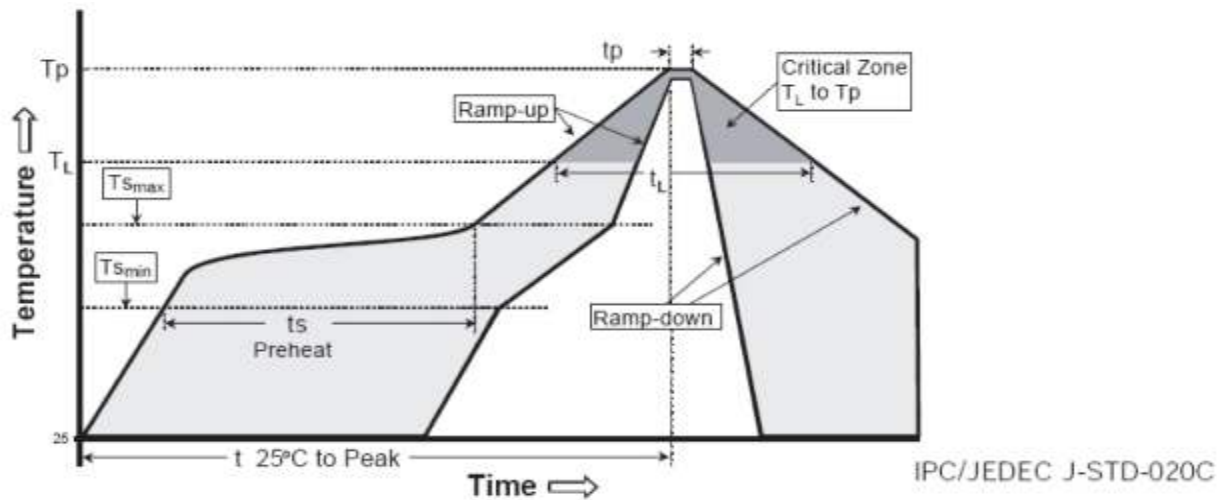

Profile Parameters	Lead-based Solder	Lead-free Solder
Average Ramp-Up Rate (T _{smax} to T _p)	3 °C/second max.	3 °C/second max.
Preheat: Temperature Min (T _{smin})	100 °C	150 °C
Preheat: Temperature Max (T _{smax})	150 °C	200 °C
Preheat: Time (t _{smin} to t _{smax})	60-120 seconds	60-180 seconds
Time Maintained Above: Temperature (T _L)	183 °C	217 °C
Time Maintained Above: Time (t _L)	60-90 seconds	60-90 seconds
Peak/Classification Temperature (T _p)	215 °C	228 °C
Time Within 5 °C of Actual Peak Temperature (t _p)	10-30 seconds	20-40 seconds
Ramp-Down Rate	6 °C/second max.	6 °C/second max.
Time 25 °C to Peak Temperature	6 minutes max.	8 minutes max.

A “no clean” solder paste is recommended so that cleaning is not required after the solder reflow. The choice of application method will determine the specific amount of solder, but for consistent results a solder stencil printer or automated dispense system is suggested.

If cleaning after reflow is required, isopropyl alcohol or water is recommended. Do not use ultrasonic cleaning. Do not wave solder or hand solder UVTOP® SMD LEDs.

Precaution for Use

UV Light

These devices are ultraviolet LEDs. During operation, the LED emits high intensity ultraviolet (UV) light, which is harmful to skin and eyes.

UV light is hazardous to skin and may cause cancer. Avoid exposure to UV light when LED is operational.

Precautions must be taken to avoid looking directly at the UV light without the use of UV light protective glasses. Do not look directly at the front of the LED or at the LED's lens when LED is operational.

Static Electricity

These products are ESD (electrostatic discharge) sensitive; static electricity and surge voltages seriously damage UV LEDs and can result in complete failure of the device. Precautions must be taken against ESD when handling or operating these devices.

Operating Conditions

In order to ensure the correct functioning of these LEDs, compliance to the maximum electrical specifications is paramount. These LEDs are particularly sensitive to any current value that exceeds the absolute maximum rating of the product. Any applied current in excess of the maximum specification will cause damage and possible complete failure of the product.

The current flowing in a LED is an exponential function of the voltage across it. A small change in voltage can produce a very large change in current and lead to complete failure of the LED. The use of current regulated drive circuits are recommended for these products.

Any attempt to drive these UV LEDs with a voltage source instead of a current source will cause damage and possible complete failure of the product.

These LEDs are susceptible to heat generation. Use care to design end product with adequate thermal management to ensure that LEDs do not exceed maximum recommended temperatures. Operating LEDs at temperatures in excess of specification will result in damage and possible complete failure of the product.

Attach the following warning labels on products/systems that use UV LEDs.



