

208223-9 ✓ ACTIVE

AMP | AMP CPC

TE Internal #: 208223-9

Circular Power Connectors, Connector Assembly, 250 VDC, Wire-to-Board / Wire-to-Panel, 9 Position, Printed Circuit Board, Receptacle, Pin, AMP CPC

[View on TE.com >](#)



Connectors > Power Connectors > Circular Power > Circular Power Connectors > Cable/Panel Mount Connector, CPC Series 1

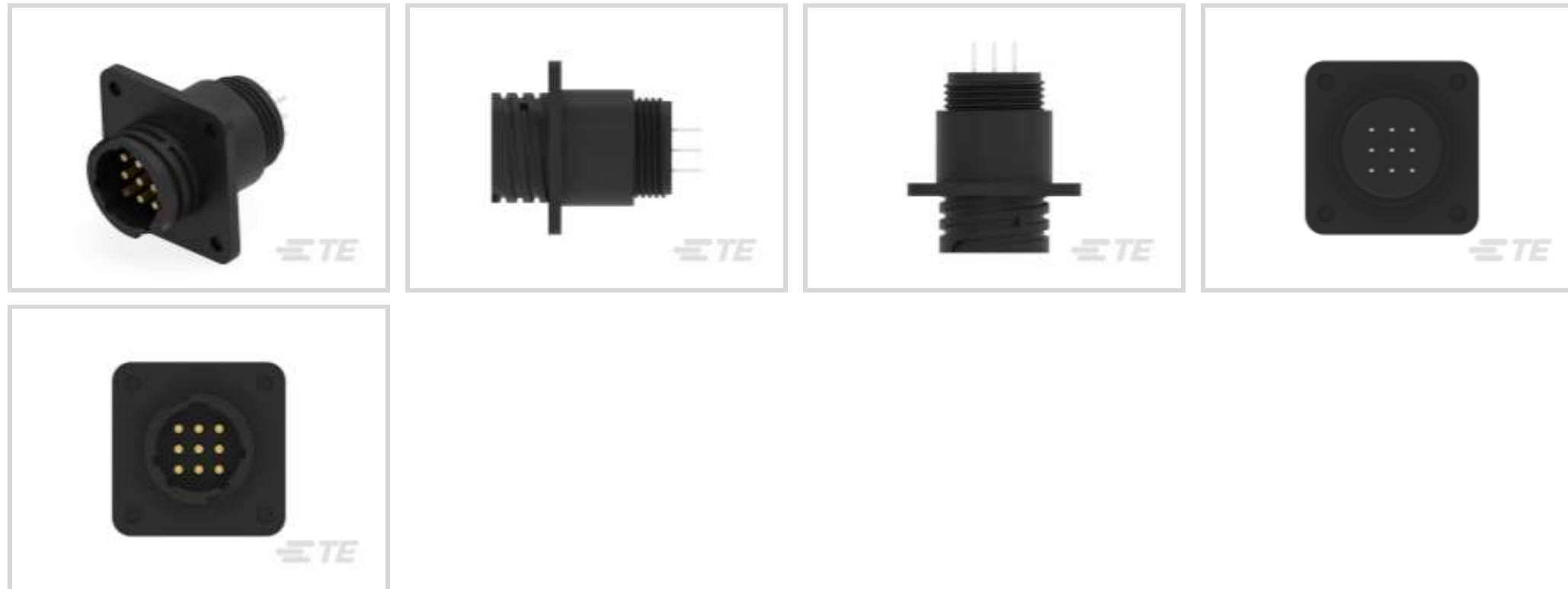

Connector Product Type: **Connector Assembly**

Operating Voltage: **250 VDC**

Connector System: **Wire-to-Board, Wire-to-Panel**

Number of Positions: **9**

Sealable: **No**

[All Cable/Panel Mount Connector, CPC Series 1 \(57\)](#)

## Features

### Product Type Features

Connector Product Type	Connector Assembly
Connector System	Wire-to-Board, Wire-to-Panel
Sealable	No
Connector & Contact Terminates To	Printed Circuit Board
Connector & Housing Type	Receptacle
Circular Connector Shell Type	All Plastic

### Configuration Features

Number of Positions	9
Number of Power Positions	0
Number of Signal Positions	9

### Electrical Characteristics

Operating Voltage	250 VAC
-------------------	---------



### Contact Features

Reverse Gender	No
Contact Type	Pin
Contact Current Rating (Max)	13 A
Contact Protection	With

### Termination Features

Termination Method to Printed Circuit Board	Through Hole - Solder
---	-----------------------

### Mechanical Attachment

Mating Alignment Type	Keyed
Mating Alignment	With
Panel Mount Feature Type	Flange with Mounting Holes
Mating Retention Type	Threaded Coupling
Polarization Code	A
Connector Mounting Type	Panel Mount
Mating Retention	With
Panel Mount Feature	With

### Housing Features

Housing Color	Black
Housing Material	PA 6.6 GF
Circular Connector Shell Size	13

### Dimensions

	1.56 in
--	---------

### Usage Conditions

Operating Temperature Range	-55 – 105 °C[-67 – 221 °F]
Fluid Resistance	None

### Operation/Application

Circuit Application	Signal
Shielded	No

### Industry Standards

UL Flammability Rating	UL 94V-0
------------------------	----------

### Packaging Features

Packaging Quantity	36
--------------------	----



Packaging Method

Standard

### Product Compliance

[For compliance documentation, visit the product page on TE.com>](#)

EU RoHS Directive 2011/65/EU

Compliant

EU ELV Directive 2000/53/EC

Compliant

China RoHS 2 Directive MIIT Order No 32, 2016

No Restricted Materials Above Threshold

EU REACH Regulation (EC) No. 1907/2006

Current ECHA Candidate List: JUNE 2023 (235)  
 Candidate List Declared Against: JUNE 2023 (235)  
 Does not contain REACH SVHC

Halogen Content

BFR/CFR/PVC Free, but Br/Cl >900 ppm in other sources.

Solder Process Capability

Wave solder capable to 265°C

#### Product Compliance Disclaimer

This information is provided based on reasonable inquiry of our suppliers and represents our current actual knowledge based on the information they provided. This information is subject to change. The part numbers that TE has identified as EU RoHS compliant have a maximum concentration of 0.1% by weight in homogenous materials for lead, hexavalent chromium, mercury, PBB, PBDE, DBP, BBP, DEHP, DIBP, and 0.01% for cadmium, or qualify for an exemption to these limits as defined in the Annexes of Directive 2011/65/EU (RoHS2). Finished electrical and electronic equipment products will be CE marked as required by Directive 2011/65/EU. Components may not be CE marked. Additionally, the part numbers that TE has identified as EU ELV compliant have a maximum concentration of 0.1% by weight in homogenous materials for lead, hexavalent chromium, and mercury, and 0.01% for cadmium, or qualify for an exemption to these limits as defined in the Annexes of Directive 2000/53/EC (ELV). Regarding the REACH Regulation, the information TE provides on SVHC in articles for this part number is based on the latest European Chemicals Agency (ECHA) 'Guidance on requirements for substances in articles' posted at this URL: <https://echa.europa.eu/guidance-documents/guidance-on-reach>

### Compatible Parts



TE Part # CAT-AM71-C83998B  
 CPC Cable Clamps



TE Part # 206708-1  
 CPC PLUG ASSEMBLY SIZE 13-9

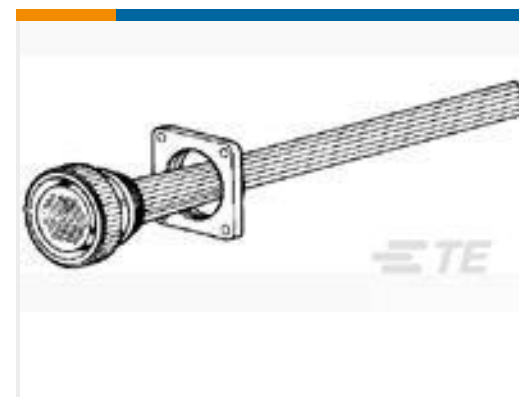

TE Part # 207299-2  
 FLANGE PLUG MOUNT CPC



TE Part # 2-2407269-3  
 CAP, CPC, SIZE 13 RECP, RED



## Also in the Series | AMP CPC

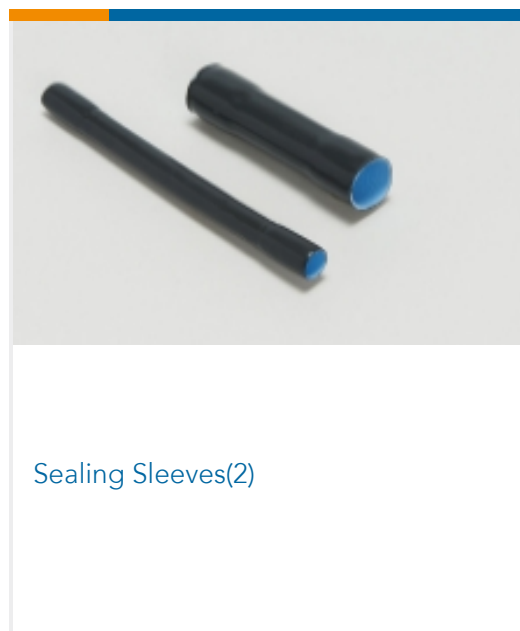
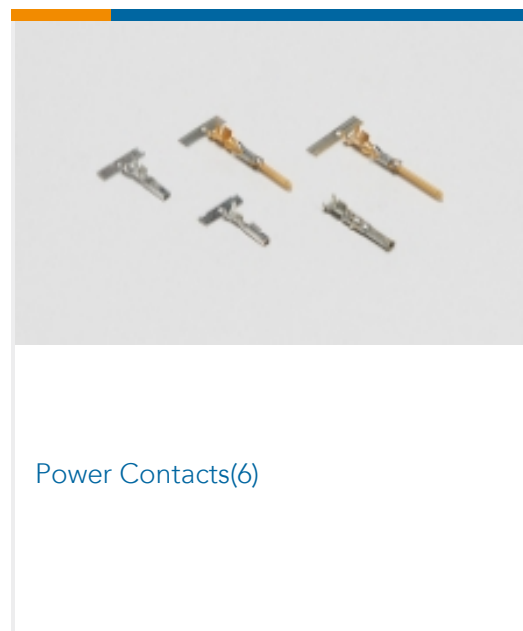
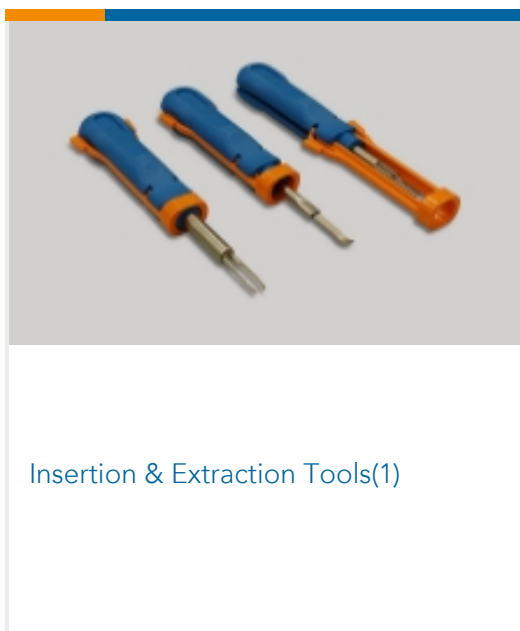
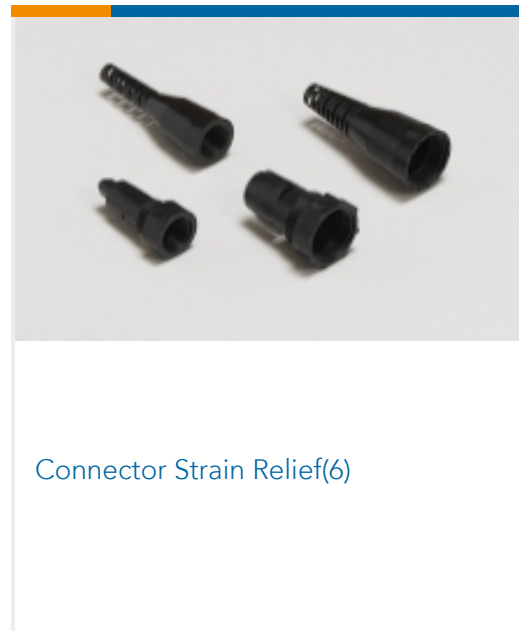
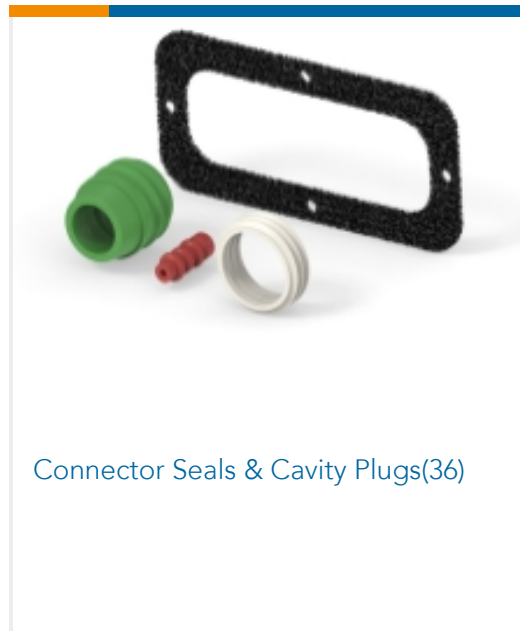
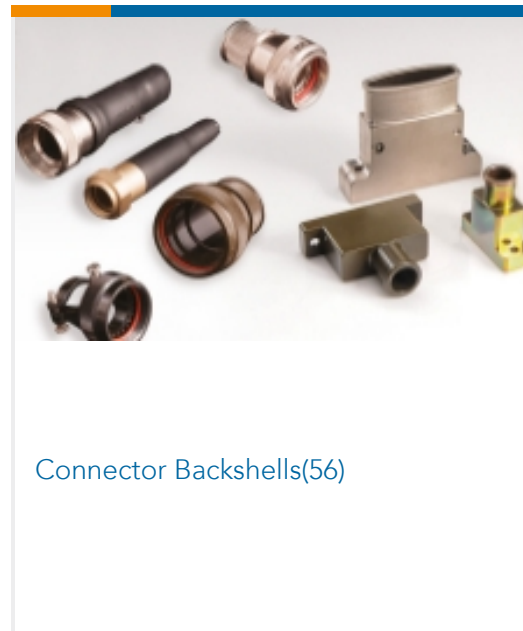
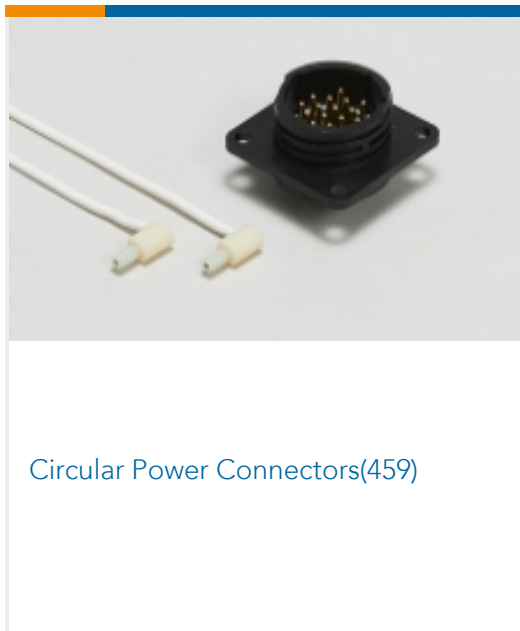
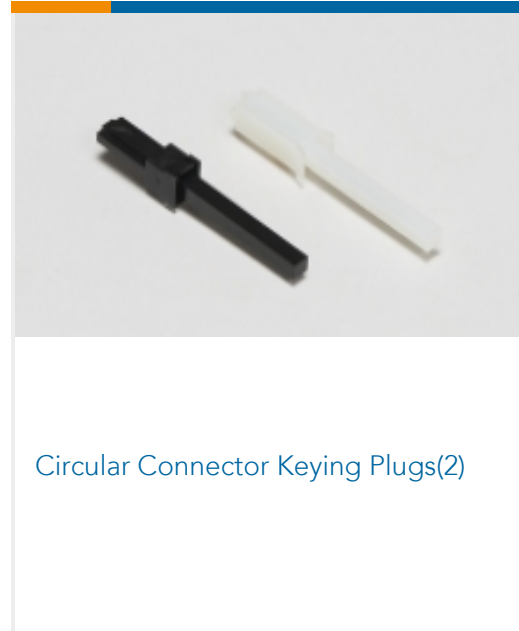
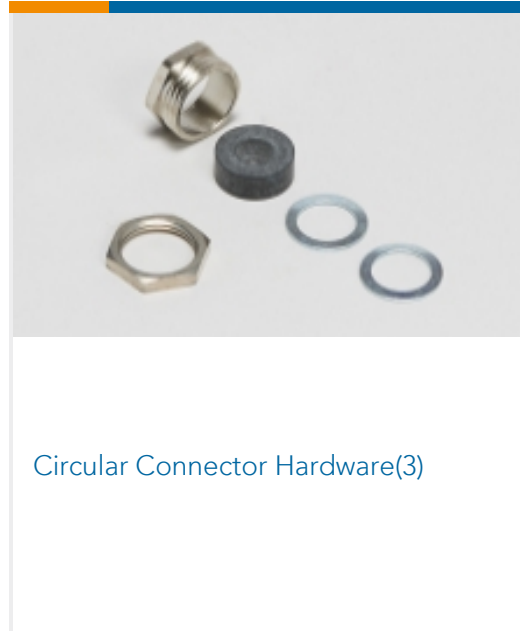
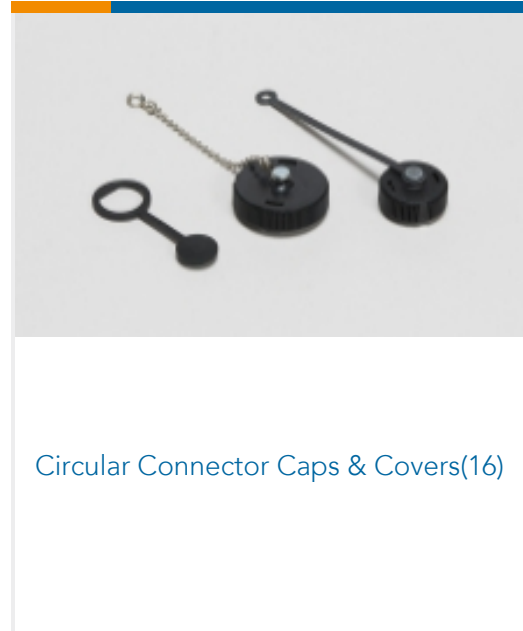
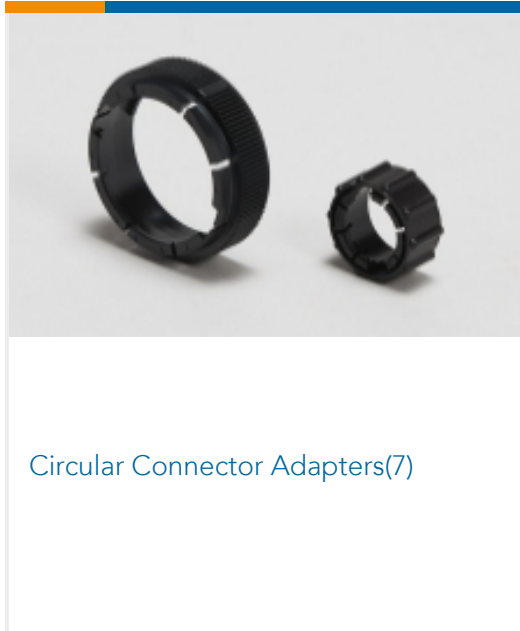

## Customers Also Bought

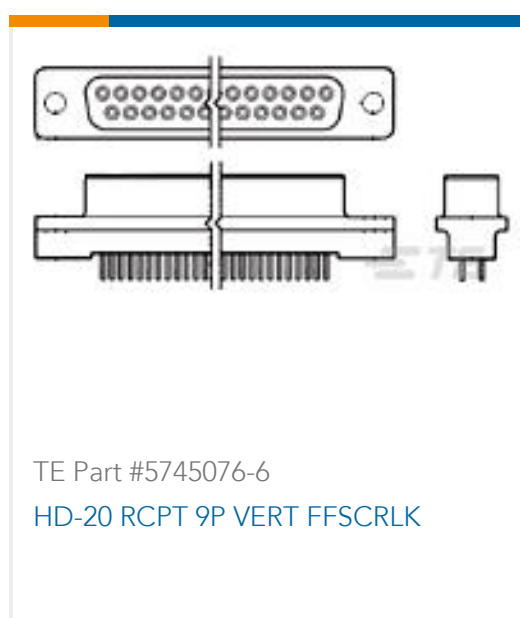
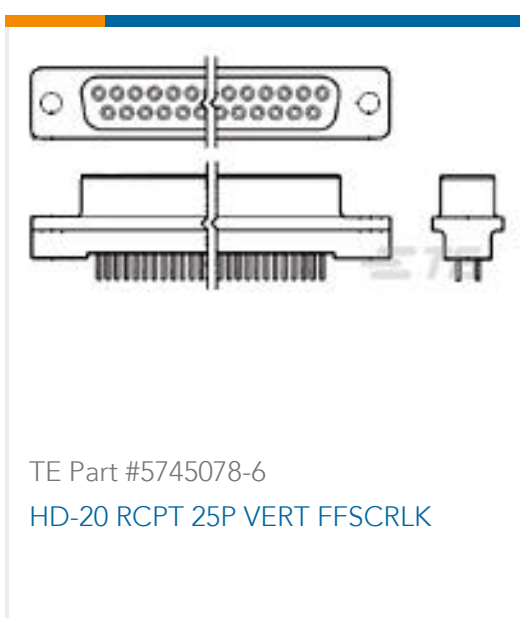

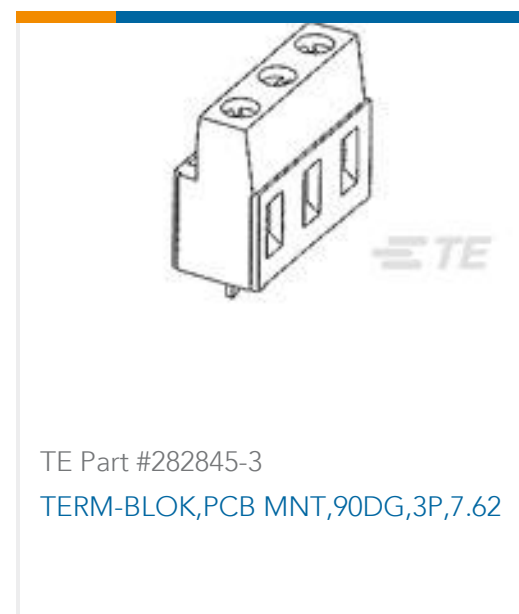

## Documents

### CAD Files

#### 3D PDF

3D

#### Customer View Model

[ENG\\_CVM\\_CVM\\_208223-9\\_AH.2d\\_dxf.zip](#)

English

#### Customer View Model

[ENG\\_CVM\\_CVM\\_208223-9\\_AH.3d\\_igs.zip](#)

English

#### Customer View Model

[ENG\\_CVM\\_CVM\\_208223-9\\_AH.3d\\_stp.zip](#)

English

#### 3D PDF

3D

#### Customer View Model

[ENG\\_CVM\\_208223-9\\_S2.3d\\_igs.zip](#)

English

#### Customer View Model

[ENG\\_CVM\\_208223-9\\_S2.3d\\_stp.zip](#)

English

#### Customer View Model

[ENG\\_CVM\\_208223-9\\_S2.2d\\_dxf.zip](#)

English

#### 3D PDF

English



---

### Datasheets & Catalog Pages

[AMP Circular Connectors for Commercial Signal & Power Applications](#)

English

---

### Product Specifications

[Application Specification](#)

English

---

### Product Environmental Compliance

[MD\\_208223-9\\_11192018830\\_dmtec](#)

English

[MD\\_208223-9\\_11192018830\\_dmtec](#)

English

---

### Agency Approvals

[UL Report](#)

English