

DATA SHEET

SKY13388-465LF: 0.05 to 2.7 GHz SP4T Switch with Integrated Logic Decoder

Applications

- WCDMA/CDMA/LTE front-end/antenna switches
- Diversity receive antenna switches

Features

- Broadband frequency range: 0.05 GHz to 2.7 GHz
- Low insertion loss: 0.60 dB typical @ 2.2 GHz, 0.65 dB typical @ 2.7 GHz
- High isolation: >30 dB typical @ 1.0 GHz, 23 dB typical @ 2.7 GHz
- V_{DD} : 2.5 to 5.5 V
- IIP3: +65 dBm typical @ 0.90 GHz
- Good 2nd and 3rd harmonic performance >75 dBc @ 2.2 GHz
- Low voltage compatible ($V_{HIGH} = 1.8$ V)
- No external components required
- Small QFN (12-pin, 2 x 2 mm) package (MSL1, 260 °C per JEDEC J-STD-020)



Skyworks Green™ products are compliant with all applicable legislation and are halogen-free. For additional information, refer to *Skyworks Definition of Green™*, document number SQ04-0074.

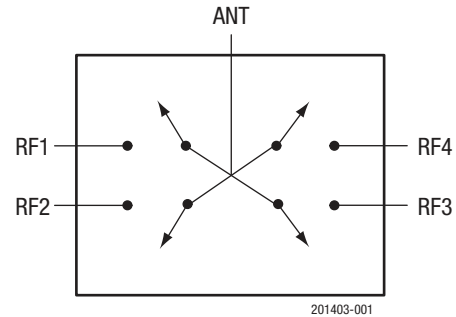

Figure 1. SKY13388-465LF Block Diagram

Description

The SKY13388-465LF is a symmetrical, single-pole, four-throw (SP4T) switch. The device is designed for broadband, medium power switching applications that demand high linearity and low insertion loss. This is a general purpose switch optimized for 3GPP bands from 0.70 to 2.7 GHz.

The switch is manufactured with an industry-leading silicon-on-insulator (SOI) process. The SKY13388-465LF features on-chip energy management circuitry that uses only two control lines for the switch operation. The low current consumption makes the device suitable for battery-operated applications.

The SKY13388-465LF SP4T switch is provided in a compact Quad Flat No-Lead (QFN) 2 x 2 mm package. A functional block diagram is shown in Figure 1. The pin configuration and package are shown in Figure 2. Signal pin assignments and functional pin descriptions are provided in Table 1.

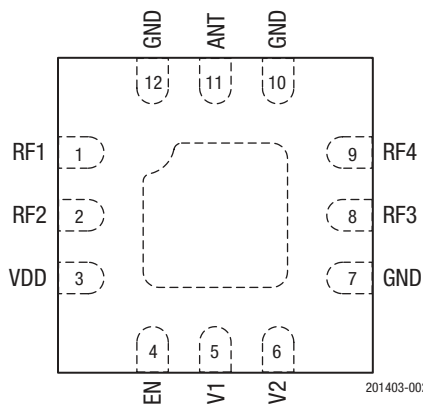

Figure 2. SKY13388-465LF Pinout (Top View)

Table 1. SKY13388-465LF Signal Descriptions¹

Pin	Name	Description	Pin	Name	Description
1	RF1	RF input 1	7	GND	Ground
2	RF2	RF input 2	8	RF3	RF input 3
3	VDD	DC power supply	9	RF4	RF input 4
4	EN	Enable	10	GND	Ground
5	V1	DC control input 1 (see Table 4)	11	ANT	RF common (antenna) port
6	V2	DC control input 2 (see Table 4)	12	GND	Ground

¹ Exposed pad must be grounded.

Electrical and Mechanical Specifications

The absolute maximum ratings of the SKY13388-465LF are provided in Table 2. Electrical specifications are provided in Table 3.

The state of the SKY13388-465LF is determined by the logic provided in Table 4.

Typical performance characteristics of the SKY13388-465LF are illustrated in Figures 3 through 8.

Table 2. SKY13388-465LF Absolute Maximum Ratings¹

Parameter	Symbol	Minimum	Typical	Maximum	Units
Supply voltage	V _{DD}			5.5	V
Control voltage	V _{CTL}			3.3	V
Input power	P _{IN}			+37	dBm
Storage temperature	T _{STG}	-40		+125	°C
Operating temperature	T _{OP}	-40		+85	°C

¹ Exposure to maximum rating conditions for extended periods may reduce device reliability. There is no damage to device with only one parameter set at the limit and all other parameters set at or below their nominal value. Exceeding any of the limits listed here may result in permanent damage to the device.

ESD HANDLING: *Although this device is designed to be as robust as possible, electrostatic discharge (ESD) can damage this device. This device must be protected at all times from ESD when handling or transporting. Static charges may easily produce potentials of several kilovolts on the human body or equipment, which can discharge without detection. Industry-standard ESD handling precautions should be used at all times.*

Table 3. SKY13388-465LF Electrical Specifications¹

(V_{DD} = 2.5 to 5.5 V, V_{CTL} = 1.8 V, T_{OP} = +25 °C, All Unused RF Ports are Terminated in a 50 Ω Load, Unless Otherwise Noted)

Parameter	Symbol	Test Condition	Min	Typical	Max	Units
Insertion loss (ANT to RF1/2/3/4)	IL	0.05 to 0.2 GHz		0.50	0.55	dB
		0.05 to 1.0 GHz		0.50	0.55	dB
		1.0 to 2.2 GHz		0.60	0.80	dB
		2.2 to 2.7 GHz		0.65	1.00	dB
Insertion loss variation	IL_VAR	0.05 to 0.2 GHz		0.01	0.05	dB
Isolation (ANT to RF1/2/3/4)	ISO	0.05 to 0.2 GHz	40	50		dB
		0.05 to 1.0 GHz	25	31		dB
		1.0 to 2.2 GHz	22	23		dB
		2.2 to 2.7 GHz	20	21		dB
Input return loss (ANT to RF1/2/3/4)	IS11I	0.05 to 2.7 GHz	20	25		dB
Output return loss (ANT to RF1/2/3/4)	IS22I, IS33I, IS44I	0.05 to 2.7 GHz	20	25		dB
Harmonics (ANT to RF1/2/3/4)		P _{IN} = +26 dBm				
		2fo: 0.1 to 0.2 GHz		-75	-70	dBm
		3fo: 0.1 to 0.2 GHz		-81	-75	dBm
		2fo: 0.8 to 1.0 GHz		-75		dBm
		3fo: 0.8 to 1.0 GHz		-81		dBm
		2fo: 1.7 to 2.2 GHz		-81		dBm
		3fo: 1.7 to 2.2 GHz		-78		dBm
		2fo: 2.5 to 2.7 GHz		-81		dBm
3fo: 2.5 to 2.7 GHz		-83		dBm		
Input 0.1 dB compression point (ANT to RF1/2/3/4)	P0.1dB	0.1 to 2.7 GHz	+35	+36		dBm
Third order input intercept point (ANT to RF1/2/3/4)	IIP3	0.1 to 2.7 GHz	+55	+65		dBm
Control voltage: High Low	V _{CTL}		1.65		3.30	V
			0		0.4	V
Control current	I _{CTL}			5		μA
Supply current	I _{CC}	V _{DD} = 2.6 V		50		μA
Supply voltage	V _{DD}		2.5		5.5	V
On switching time	t _{ON}	RF1/2/3/4: 50% EN to 90% RF		550	1000	ns
Off switching time	t _{OFF}	RF1/2/3/4: 50% EN to 10% RF		550	1000	ns
Transition time	t _{TRANS}	RF1/2/3/4: 50% V _{CTL} to 10% RF		550	1000	ns
Rise time	t _{RISE}	RF1/2/3/4: 10% to 90% RF		250	500	ns
Fall time	t _{FALL}	RF1/2/3/4: 90% to 10% RF		100	250	ns
Shutdown to active mode timing		Standby to 90%		5		μs

¹ Performance is guaranteed only under the conditions listed in this table.

Table 4. SKY13388-465LF Truth Table

State	EN (Pin 4)	V1 (Pin 5)	V2 (Pin 6)
Shutdown	0	X	X
ANT to RF1	1	0	0
ANT to RF2	1	0	1
ANT to RF3	1	1	0
ANT to RF4	1	1	1

Note: 1 = 1.65 to 3.30 V
 0 = 0 to 0.4 V
 X = "don't care"
 Any state other than described in this table places the switch into an undefined state.

Typical Performance Characteristics

($V_{DD} = 2.5$ to 5.5 V, $V_{CTL} = 1.8$ V, $T_{OP} = +25$ °C, All Unused RF Ports are Terminated in a $50\ \Omega$ Load, Unless Otherwise Noted)

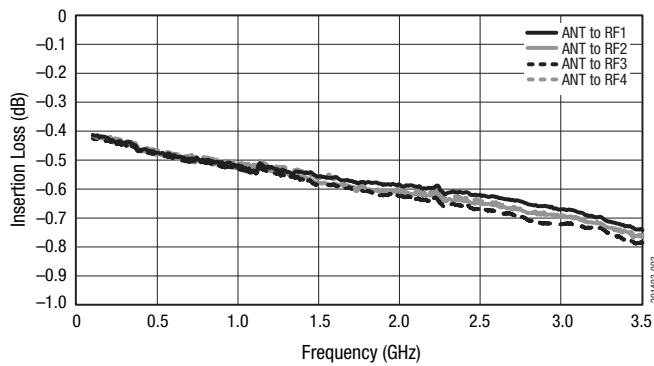

Figure 3. Insertion Loss vs Frequency

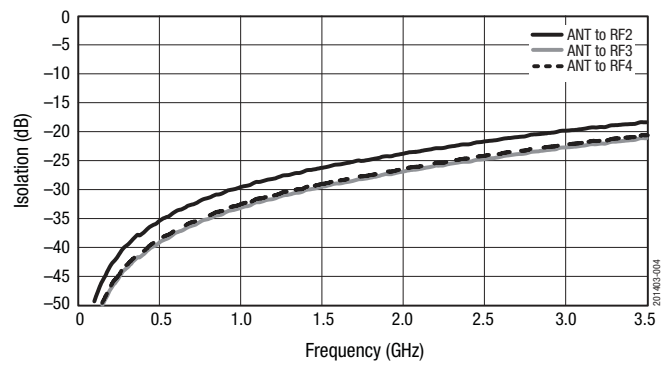

Figure 4. Isolation vs Frequency (ANT to RF1 Insertion Loss State)

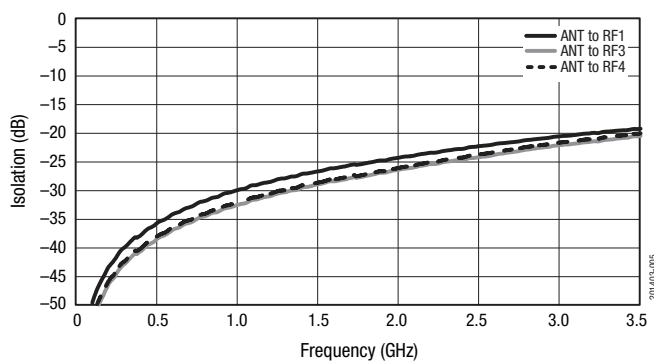

Figure 5. Isolation vs Frequency (RFC to V2 Insertion Loss State)

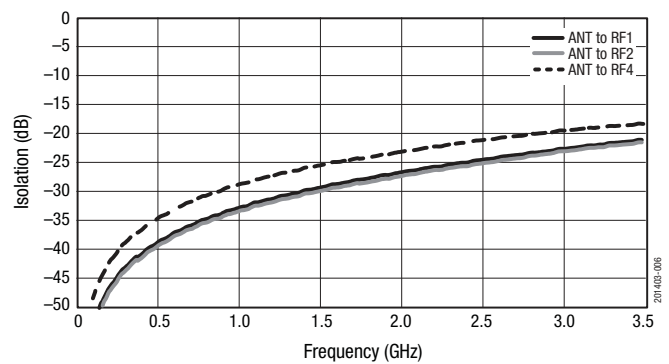
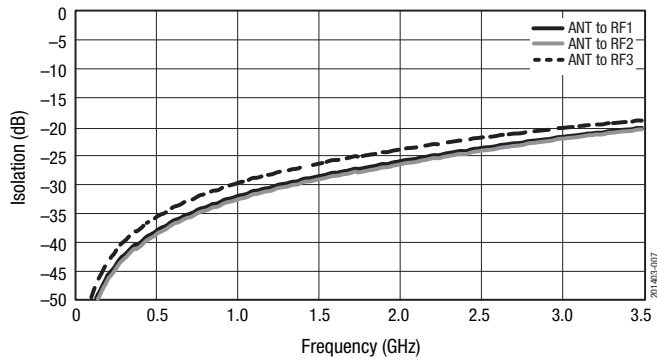

Figure 6. Isolation vs Frequency (ANT to RF3 Insertion Loss State)



**Figure 7. Isolation vs Frequency
(ANT to RF4 Insertion Loss State)**

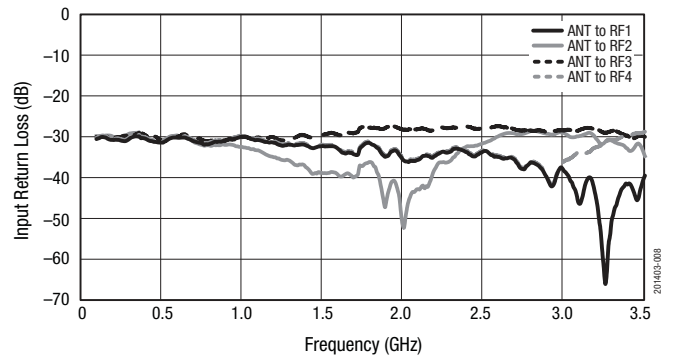
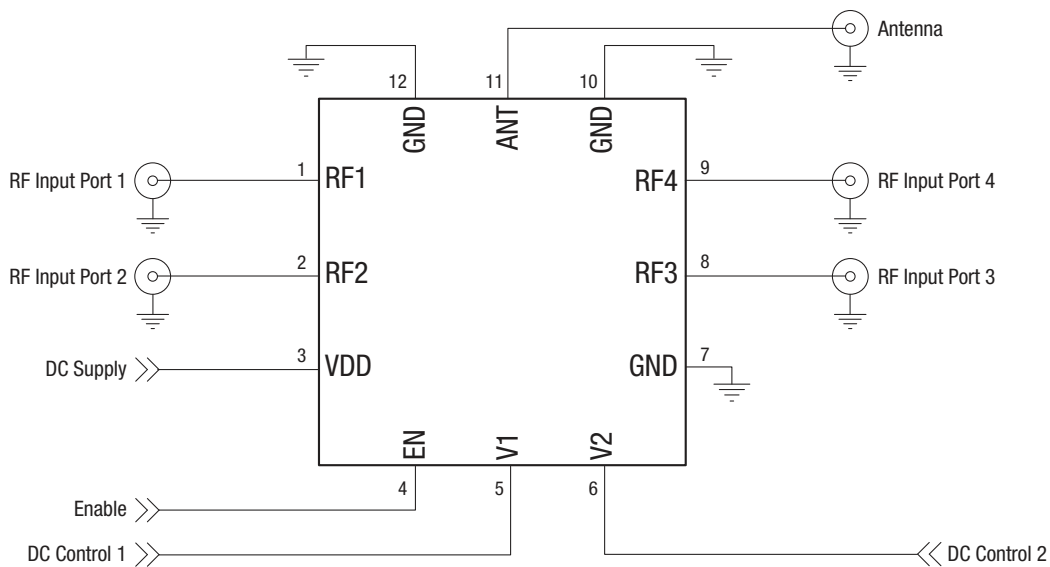

Figure 8. Input Return Loss vs Frequency

Evaluation Board Description

The SKY13388-465LF Evaluation Board is used to test the performance of the SKY13388-465LF SP4T Switch.

An Evaluation Board schematic diagram is provided in Figure 9. An assembly drawing for the Evaluation Board is shown in Figure 10.



201403-009

Figure 9. SKY13388-465LF Evaluation Board Schematic

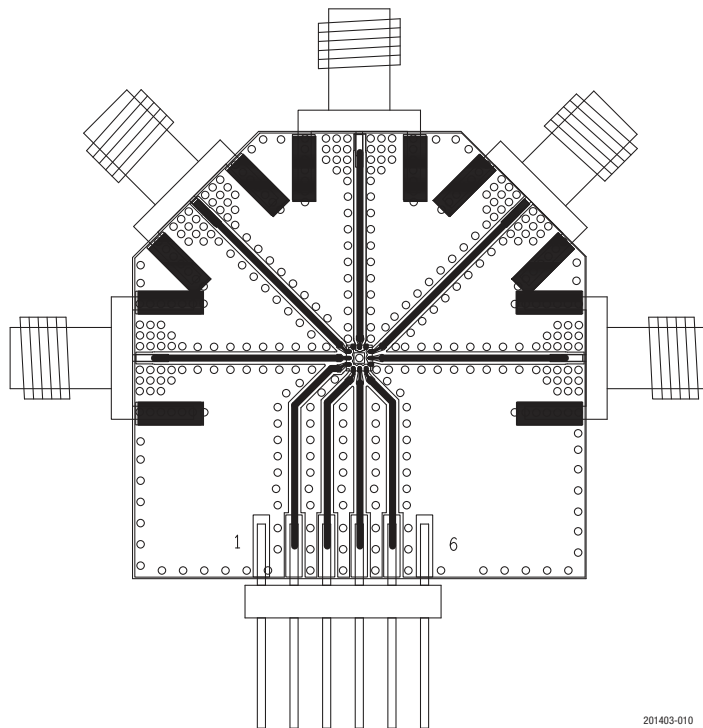

201403-010

Figure 10. SKY13388-465LF Evaluation Board Assembly Diagram

Package Dimensions

The PCB layout footprint for the SKY13388-465LF is provided in Figure 11. Typical part markings are shown in Figure 12. Package dimensions are shown in Figure 13, and tape and reel dimensions are provided in Figure 14.

Package and Handling Information

Instructions on the shipping container label regarding exposure to moisture after the container seal is broken must be followed. Otherwise, problems related to moisture absorption may occur when the part is subjected to high temperature during solder assembly.

The SKY13388-465LF is rated to Moisture Sensitivity Level 1 (MSL1) at 260 °C. It can be used for lead or lead-free soldering. For additional information, refer to the Skyworks Application Note, *Solder Reflow Information*, document number 200164.

Care must be taken when attaching this product, whether it is done manually or in a production solder reflow environment. Production quantities of this product are shipped in a standard tape and reel format.

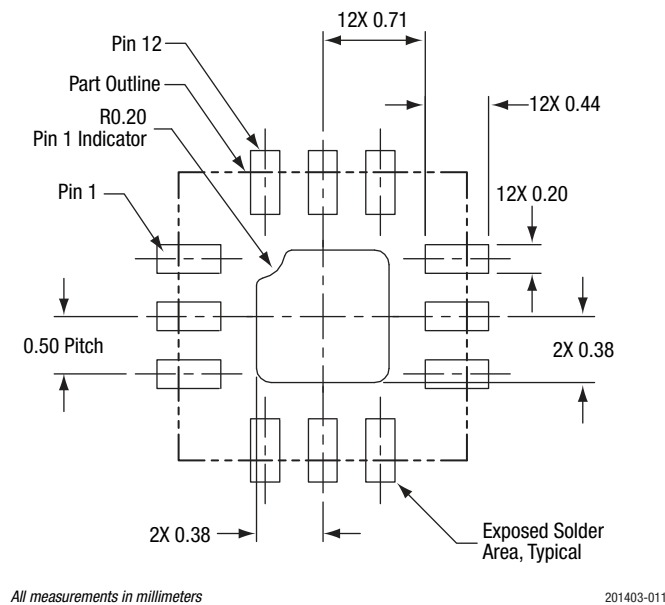

Figure 11. SKY13388-465LF PCB Layout Footprint (Top View)

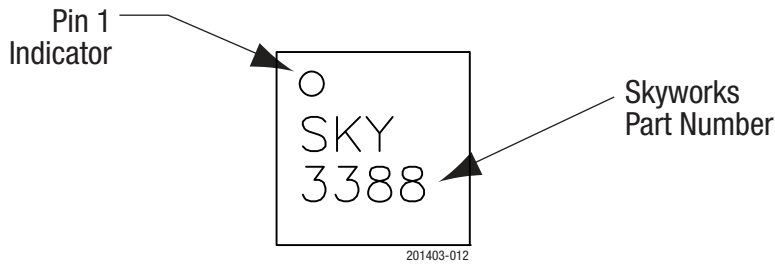
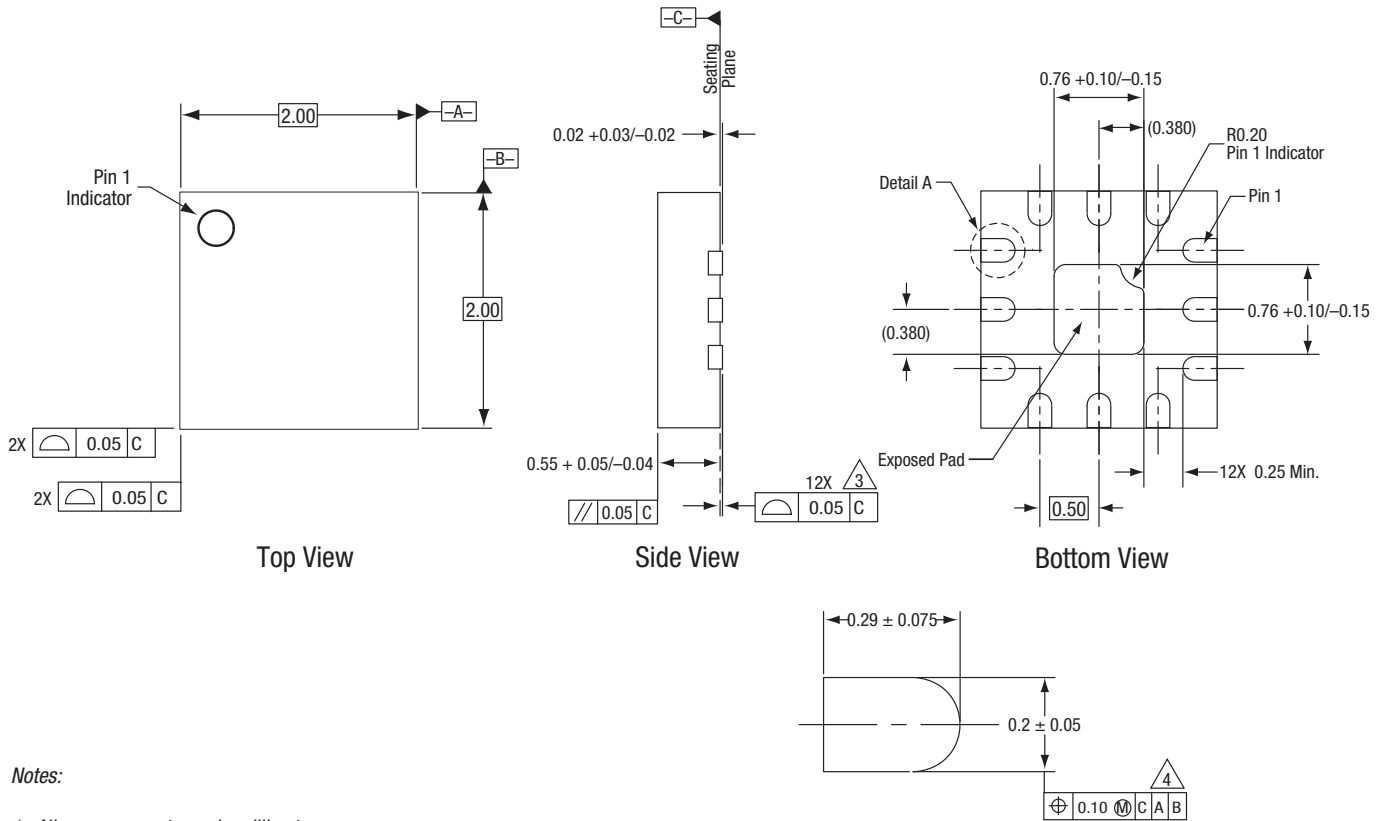

Figure 12. Typical Part Markings (Top View)



Notes:

1. All measurements are in millimeters.
2. Dimensions and tolerances according to ASME Y14.5M-1994.
3. Coplanarity applies to the terminals and all other bottom surface metallization.
4. Dimension applies to metallized terminal. If the terminal has a radius on its end, the width dimension should not be measured in that radius area.

Detail A
Scale: 100X
12 Places

S2198

Figure 13. SKY13388-465LF Package Dimensions

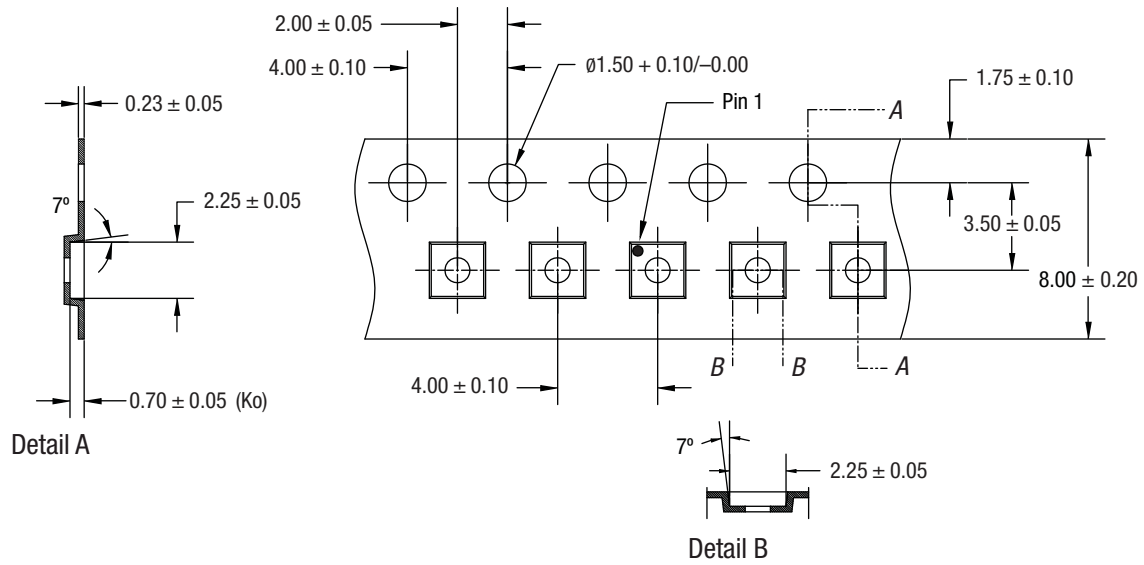

Notes:

1. Carrier tape must meet all requirements of Skyworks GP01-D232 procurement spec for tape and reel shipping.
2. Carrier tape shall be black conductive polycarbonate bakeable material at 125 °C temperature.
3. Cover tape shall be transparent conductive with 5.40 mm width.
4. ESD-surface resistivity must meet all ESD requirements of Skyworks specified on GP01-D232.
5. All measurements are in millimeters.

201403-014

Figure 14. SKY13388-465LF Tape and Reel Dimensions

Ordering Information

Model Name	Manufacturing Part Number	Evaluation Board Part Number
SKY13388-465LF SP4T Switch	SKY13388-465LF	SKY13388-465LF-EVB

Copyright © 2010-2015, 2017 Skyworks Solutions, Inc. All Rights Reserved.

Information in this document is provided in connection with Skyworks Solutions, Inc. (“Skyworks”) products or services. These materials, including the information contained herein, are provided by Skyworks as a service to its customers and may be used for informational purposes only by the customer. Skyworks assumes no responsibility for errors or omissions in these materials or the information contained herein. Skyworks may change its documentation, products, services, specifications or product descriptions at any time, without notice. Skyworks makes no commitment to update the materials or information and shall have no responsibility whatsoever for conflicts, incompatibilities, or other difficulties arising from any future changes.

No license, whether express, implied, by estoppel or otherwise, is granted to any intellectual property rights by this document. Skyworks assumes no liability for any materials, products or information provided hereunder, including the sale, distribution, reproduction or use of Skyworks products, information or materials, except as may be provided in Skyworks Terms and Conditions of Sale.

THE MATERIALS, PRODUCTS AND INFORMATION ARE PROVIDED “AS IS” WITHOUT WARRANTY OF ANY KIND, WHETHER EXPRESS, IMPLIED, STATUTORY, OR OTHERWISE, INCLUDING FITNESS FOR A PARTICULAR PURPOSE OR USE, MERCHANTABILITY, PERFORMANCE, QUALITY OR NON-INFRINGEMENT OF ANY INTELLECTUAL PROPERTY RIGHT; ALL SUCH WARRANTIES ARE HEREBY EXPRESSLY DISCLAIMED. SKYWORKS DOES NOT WARRANT THE ACCURACY OR COMPLETENESS OF THE INFORMATION, TEXT, GRAPHICS OR OTHER ITEMS CONTAINED WITHIN THESE MATERIALS. SKYWORKS SHALL NOT BE LIABLE FOR ANY DAMAGES, INCLUDING BUT NOT LIMITED TO ANY SPECIAL, INDIRECT, INCIDENTAL, STATUTORY, OR CONSEQUENTIAL DAMAGES, INCLUDING WITHOUT LIMITATION, LOST REVENUES OR LOST PROFITS THAT MAY RESULT FROM THE USE OF THE MATERIALS OR INFORMATION, WHETHER OR NOT THE RECIPIENT OF MATERIALS HAS BEEN ADVISED OF THE POSSIBILITY OF SUCH DAMAGE.

Skyworks products are not intended for use in medical, lifesaving or life-sustaining applications, or other equipment in which the failure of the Skyworks products could lead to personal injury, death, physical or environmental damage. Skyworks customers using or selling Skyworks products for use in such applications do so at their own risk and agree to fully indemnify Skyworks for any damages resulting from such improper use or sale.

Customers are responsible for their products and applications using Skyworks products, which may deviate from published specifications as a result of design defects, errors, or operation of products outside of published parameters or design specifications. Customers should include design and operating safeguards to minimize these and other risks. Skyworks assumes no liability for applications assistance, customer product design, or damage to any equipment resulting from the use of Skyworks products outside of stated published specifications or parameters.

Skyworks and the Skyworks symbol are trademarks or registered trademarks of Skyworks Solutions, Inc., in the United States and other countries. Third-party brands and names are for identification purposes only, and are the property of their respective owners. Additional information, including relevant terms and conditions, posted at www.skyworksinc.com, are incorporated by reference.