

Features

- ±2.0% Tolerance on Breakdown Voltage
- Small, Low Profile Surface Mount Package
- Flat Lead Package Design for Low Profile and High Power Dissipation
- **Totally Lead-Free & Fully RoHS Compliant (Notes 1 & 2)**
- **Halogen and Antimony Free. "Green" Device (Note 3)**
- **The BZT585B2V4TQ - BZT585B43TQ is suitable for automotive applications requiring specific change control and is AEC-Q101 qualified, is PPAP capable, and is manufactured in IATF16949:2016 certified facilities.**
- <https://www.diodes.com/quality/product-definitions/>

Mechanical Data

- Case: SOD523
- Case Material: Molded Plastic, "Green" Molding Compound. UL Flammability Classification Rating 94V-0
- Moisture Sensitivity: Level 1 per J-STD-020
- Terminal Connections: Cathode Band
- Terminals: Finish—Matte Tin Annealed over Alloy 42 Leadframe. Solderable per MIL-STD-202, Method 208 (E3)
- Weight: 0.001 grams (Approximate)

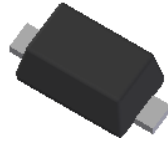

Top View

Ordering Information (Note 4)

Part Number	Qualification	Case	Packaging
(Type Number)-7*	Automotive	SOD523	3000/Tape & Reel
(Type Number)-13*	Automotive	SOD523	10,000/Tape & Reel

*For (Type Number), please see the Electrical Characteristics Table. Example: 6.2V Zener = BZT585B6V2TQ-7.

- Notes:
1. No purposely added lead. Fully EU Directive 2002/95/EC (RoHS), 2011/65/EU (RoHS 2) & 2015/863/EU (RoHS 3) compliant.
 2. See <https://www.diodes.com/quality/lead-free/> for more information about Diodes Incorporated's definitions of Halogen- and Antimony-free, "Green" and Lead-free.
 3. Halogen- and Antimony-free "Green" products are defined as those which contain <900ppm bromine, <900ppm chlorine (<1500ppm total Br + Cl) and <1000ppm antimony compounds.
 4. For packaging details, go to our website at <http://www.diodes.com/products/packages.html>.

Marking Information



xx = Product Type Marking Code
(See Electrical Characteristics Table)

Maximum Ratings (@T_A = +25°C, unless otherwise specified.)

Single phase, half wave, 60Hz, resistive, or inductive load.
For capacitance load, derate current by 20%.

Characteristic	Symbol	Value	Unit
Forward Voltage	V _F	@ I _F = 10mA	0.9
		@ I _F = 100mA	1.1
Continuous Forward Current	I _F	200	mA

Thermal Characteristics

Characteristic	Symbol	Value	Unit
Power Dissipation (Note 5)	P _D	350	mW
Thermal Resistance, Junction to Ambient Air (Note 5)	R _{θJA}	357	°C/W
Operating and Storage Temperature Range	T _J , T _{STG}	-65 to +150	°C

Note: 5. Device mounted on FR-4 PCB with minimum recommended pad layout, as shown on our website at <http://www.diodes.com/package-outlines.html>.

Electrical Characteristics (@T_A = +25°C, unless otherwise specified.)

Type Number	Marking Codes	Zener Voltage Range (Note 6)				Maximum Zener Impedance (Note 7)			Temperature Coefficient	Total Capacitance	Maximum Reverse Current (Note 6)	
		V _Z @ I _{ZT}			I _{ZT}	Z _{ZT} @ I _{ZT}	Z _{ZK} @ I _{ZK}	I _{ZK}	TC @ I _{ZT}	C _T @ f = 1MHz, V _R = 0V	I _R	@ V _R
		Nom (V)	Min (V)	Max (V)	mA	Ω	mA	Typical (mV/°C)	Max (pF)	μA	V	
BZT585B2V4TQ	3C	2.4	2.35	2.45	5	100	400	1	-1.3	450	50	1
BZT585B3V6TQ	3J	3.6	3.53	3.67	5	90	500	1	-1.9	390	5	1
BZT585B3V9TQ	3K	3.9	3.82	3.98	5	90	500	1	-1.9	370	3	1
BZT585B5V1TQ	3N	5.1	5.00	5.20	5	60	480	1	-0.5	300	2	2
BZT585B5V6TQ	3P	5.6	5.49	5.71	5	40	400	1	1.0	275	1	2
BZT585B6V2TQ	3S	6.2	6.08	6.32	5	10	150	1	2.2	250	3	4
BZT585B6V8TQ	3T	6.8	6.66	6.94	5	15	80	1	3.0	215	2	4
BZT585B7V5TQ	3U	7.5	7.35	7.65	5	10	80	1	3.8	170	1	5
BZT585B8V2TQ	3V	8.2	8.04	8.36	5	10	80	1	4.7	150	0.7	5
BZT585B9V1TQ	3X	9.1	8.92	9.28	5	10	100	1	5.8	120	0.5	6
BZT585B10TQ	3Y	10	9.80	10.20	5	10	150	1	7.0	110	0.2	7
BZT585B11TQ	3Z	11	10.78	11.22	5	10	150	1	8.2	110	0.1	8
BZT585B12TQ	4A	12	11.76	12.24	5	10	150	1	9.5	105	0.1	8
BZT585B13TQ	4B	13	12.74	13.26	5	10	170	1	10.7	105	0.1	8
BZT585B15TQ	4D	15	14.70	15.30	5	15	200	1	13.2	100	0.05	10.5
BZT585B16TQ	4E	16	15.68	16.32	5	40	200	1	14.4	90	0.05	11.2
BZT585B18TQ	4F	18	17.64	18.36	5	45	225	1	16.9	80	0.05	12.6
BZT585B20TQ	4G	20	19.60	20.40	5	55	225	1	19.4	70	0.05	14.0
BZT585B22TQ	4H	22	21.56	22.44	5	55	250	1	21.9	60	0.05	15.4
BZT585B24TQ	4J	24	23.52	24.48	5	70	250	1	24.4	55	0.05	16.8
BZT585B27TQ	4K	27	26.46	27.54	2	80	300	0.5	25.4	50	0.05	18.9
BZT585B30TQ	4M	30	29.40	30.60	2	80	300	0.5	31.1	50	0.05	21.0
BZT585B33TQ	4N	33	32.34	33.66	2	80	325	0.5	36.7	45	0.05	23.1
BZT585B36TQ	4P	36	35.28	36.72	2	90	350	0.5	42.4	45	0.05	25.2
BZT585B39TQ	4R	39	38.22	39.78	2	130	350	0.5	48.1	45	0.05	27.3
BZT585B43TQ	4S	43	42.14	43.86	2	150	375	0.5	55.7	40	0.05	30.1

Notes: 6. Short duration pulse test used to minimize self-heating effect.
7. f = 1kHz.

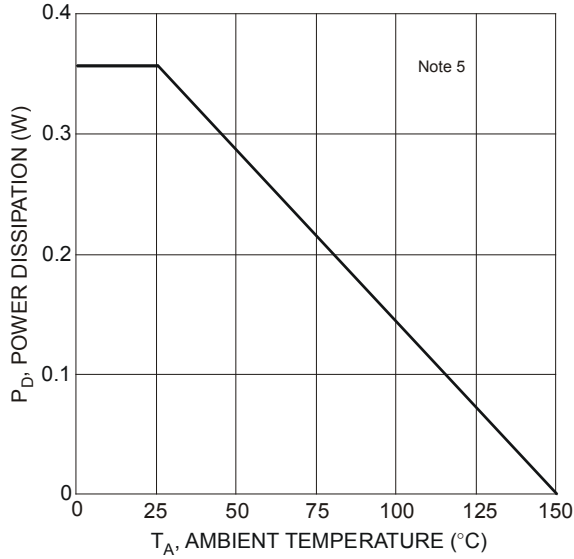

Figure 1 Power Derating Curve

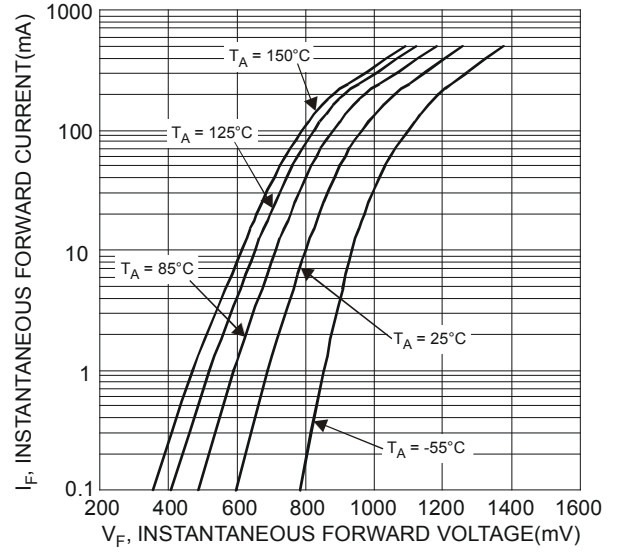

Figure 2 Typical Forward Characteristics

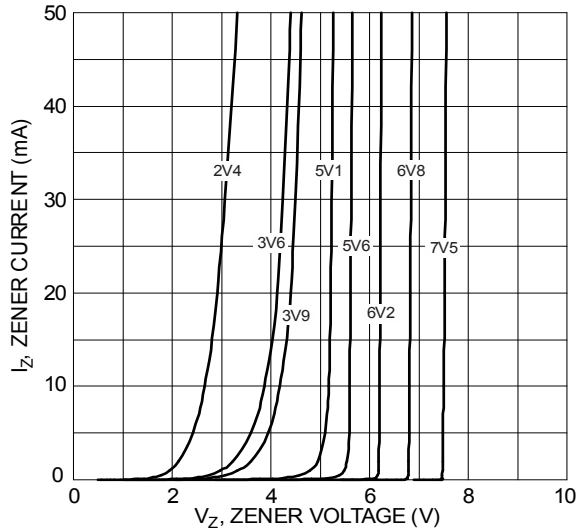

Figure 3 Typical Zener Breakdown Characteristics
BZT585B2V4TQ - BZT585B7V5TQ

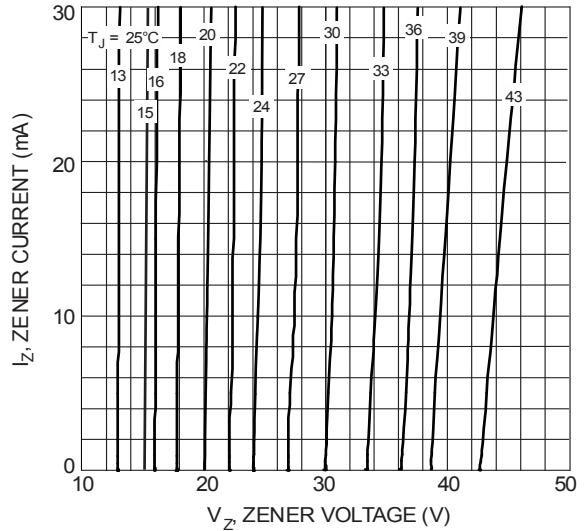
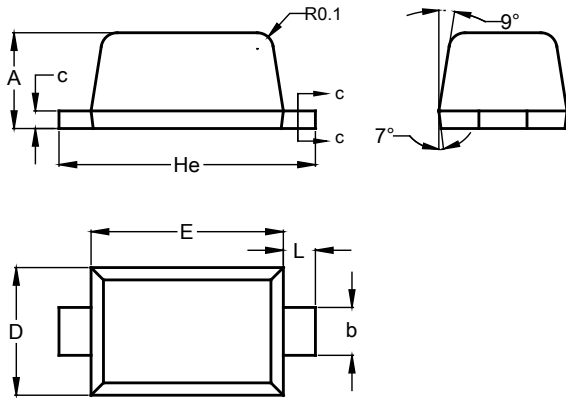

Figure 4 Typical Zener Breakdown Characteristics
BZT585B13TQ - BZT585B43TQ

Package Outline Dimensions

Please see <http://www.diodes.com/package-outlines.html> for the latest version.

SOD523



SOD523		
Dim	Min	Max
A	0.55	0.65
b	0.26	0.34
c	0.11	0.17
D	0.75	0.85
E	1.15	1.25
He	1.55	1.65
L	0.10	0.30
All Dimensions in mm		

Suggested Pad Layout

Please see <http://www.diodes.com/package-outlines.html> for the latest version.

SOD523

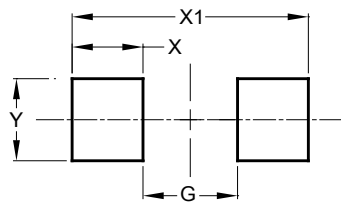

Dimensions	Value (in mm)
G	0.80
X	0.60
X1	2.00
Y	0.70

IMPORTANT NOTICE

DIODES INCORPORATED MAKES NO WARRANTY OF ANY KIND, EXPRESS OR IMPLIED, WITH REGARDS TO THIS DOCUMENT, INCLUDING, BUT NOT LIMITED TO, THE IMPLIED WARRANTIES OF MERCHANTABILITY AND FITNESS FOR A PARTICULAR PURPOSE (AND THEIR EQUIVALENTS UNDER THE LAWS OF ANY JURISDICTION).

Diodes Incorporated and its subsidiaries reserve the right to make modifications, enhancements, improvements, corrections or other changes without further notice to this document and any product described herein. Diodes Incorporated does not assume any liability arising out of the application or use of this document or any product described herein; neither does Diodes Incorporated convey any license under its patent or trademark rights, nor the rights of others. Any Customer or user of this document or products described herein in such applications shall assume all risks of such use and will agree to hold Diodes Incorporated and all the companies whose products are represented on Diodes Incorporated website, harmless against all damages.

Diodes Incorporated does not warrant or accept any liability whatsoever in respect of any products purchased through unauthorized sales channel. Should Customers purchase or use Diodes Incorporated products for any unintended or unauthorized application, Customers shall indemnify and hold Diodes Incorporated and its representatives harmless against all claims, damages, expenses, and attorney fees arising out of, directly or indirectly, any claim of personal injury or death associated with such unintended or unauthorized application.

Products described herein may be covered by one or more United States, international or foreign patents pending. Product names and markings noted herein may also be covered by one or more United States, international or foreign trademarks.

This document is written in English but may be translated into multiple languages for reference. Only the English version of this document is the final and determinative format released by Diodes Incorporated.

LIFE SUPPORT

Diodes Incorporated products are specifically not authorized for use as critical components in life support devices or systems without the express written approval of the Chief Executive Officer of Diodes Incorporated. As used herein:

A. Life support devices or systems are devices or systems which:

1. are intended to implant into the body, or
2. support or sustain life and whose failure to perform when properly used in accordance with instructions for use provided in the labeling can be reasonably expected to result in significant injury to the user.

B. A critical component is any component in a life support device or system whose failure to perform can be reasonably expected to cause the failure of the life support device or to affect its safety or effectiveness.

Customers represent that they have all necessary expertise in the safety and regulatory ramifications of their life support devices or systems, and acknowledge and agree that they are solely responsible for all legal, regulatory and safety-related requirements concerning their products and any use of Diodes Incorporated products in such safety-critical, life support devices or systems, notwithstanding any devices- or systems-related information or support that may be provided by Diodes Incorporated. Further, Customers must fully indemnify Diodes Incorporated and its representatives against any damages arising out of the use of Diodes Incorporated products in such safety-critical, life support devices or systems.

Copyright © 2019, Diodes Incorporated

www.diodes.com