

SF2442E-1

**1565.5 MHz
SAW Filter**

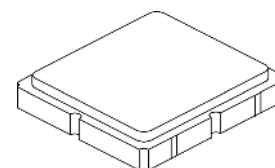

SM3030-6

- **Surface Mount 3.0 x 3.0 mm Package**
- **Complies with Directive 2002/95/EC (RoHS)**
- **Absolute Maximum Ratings**
- **Moisture Sensitivity Level: 1**
- **AEC-Q200 Qualified**

Rating	Value	Units
Input Power Level	15	dBm
DC Voltage on any Non-ground Terminal	3	V
Operable Temperature Range	-45 to +125	°C
Specification Temperature Range	-40 to +105	°C
Storage Temperature Range in Tape and Reel	-40 to +85	°C

Electrical Characteristics

Characteristic	Sym	Notes	Min	Typ	Max	Units
Center Frequency	f_c			1565.5		MHz
3 dB Bandwidth				150		MHz
Insertion Loss, (1525 to 1606 MHz)	IL			3.1	3.7	dB
Return Loss, (1525 to 1606 MHz)				10		dB
Passband Ripple (1525 to 1606 MHz)				0.6	2.0	
Group Delay Variation (1525 to 1606 MHz) (1525 to 1606 MHz on 2 MHz sliding window) (ref - 1573.374 to 1577.466 MHz) (ref - 1597.55 to 1605.886 MHz)				2.0	15.0	ns
				1.2	15.0	
				0.5	5.0	
				1.0	5.0	
Attenuation, Referenced from 0 dB:						dB
100 to 1320 MHz				29		
1320 to 1420 MHz			30	40		
1740 to 2000 MHz			30	40		
2000 to 4000 MHz				21		
4000 to 6000 MHz				16		
Temperature coefficient of frequency				-80		Ppm/°C
Source Impedance				50		Ω
Load Impedance				50		
Case Style	SM3030-6 3.0 x 3.0 mm Nominal Footprint					
Lid Symbolization (Y=year, WW=week, S=shift) dot=pin 1 indicator	9F, YWWS					

Measurement Circuit

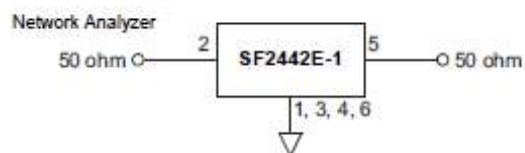

Electrical Connections

Connection	Terminals
Input	2
Output	5
Case Ground	All others

CAUTION: Electrostatic Sensitive Device. Observe precautions for handling.

NOTES:

1. The design, manufacturing process, and specifications of this device are subject to change.
2. US or International patents may apply.
3. RoHS compliant from the first date of manufacture.

Frequency Characteristics

Narrow Band Response

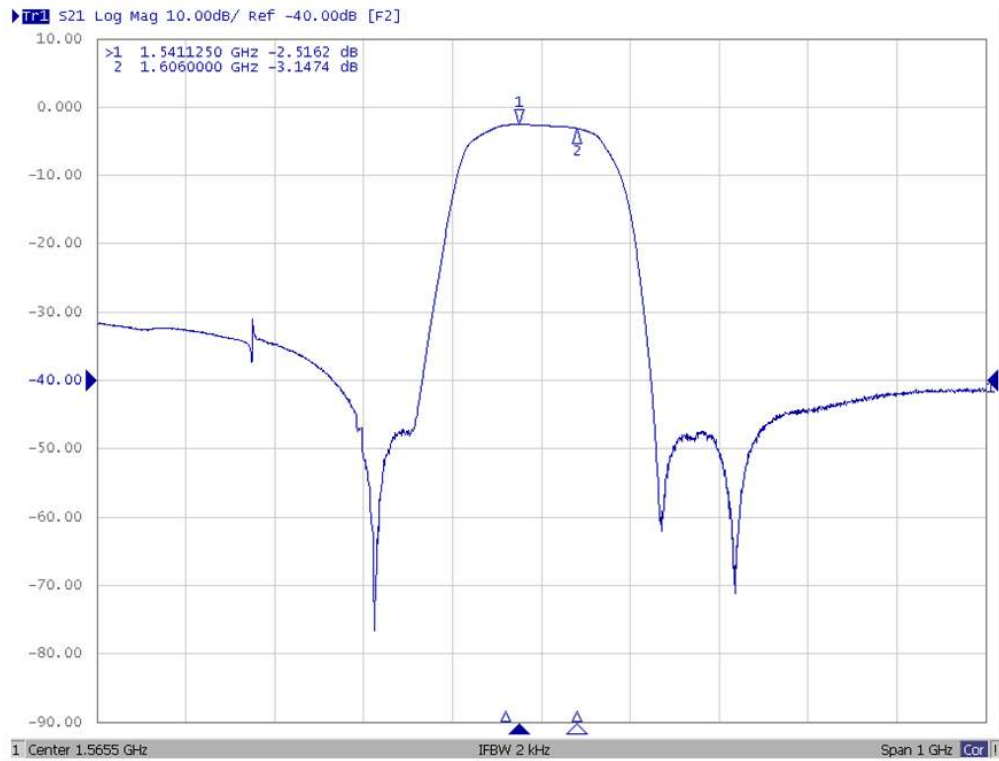

Group Time Delay Response

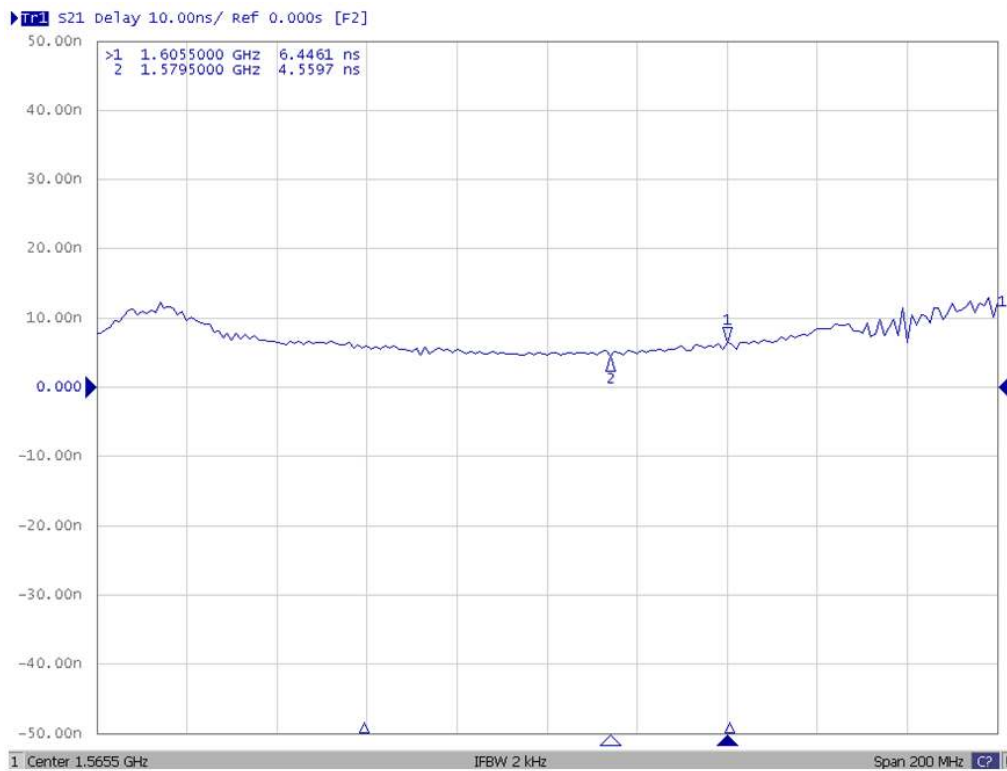

Frequency Characteristics

VSWR

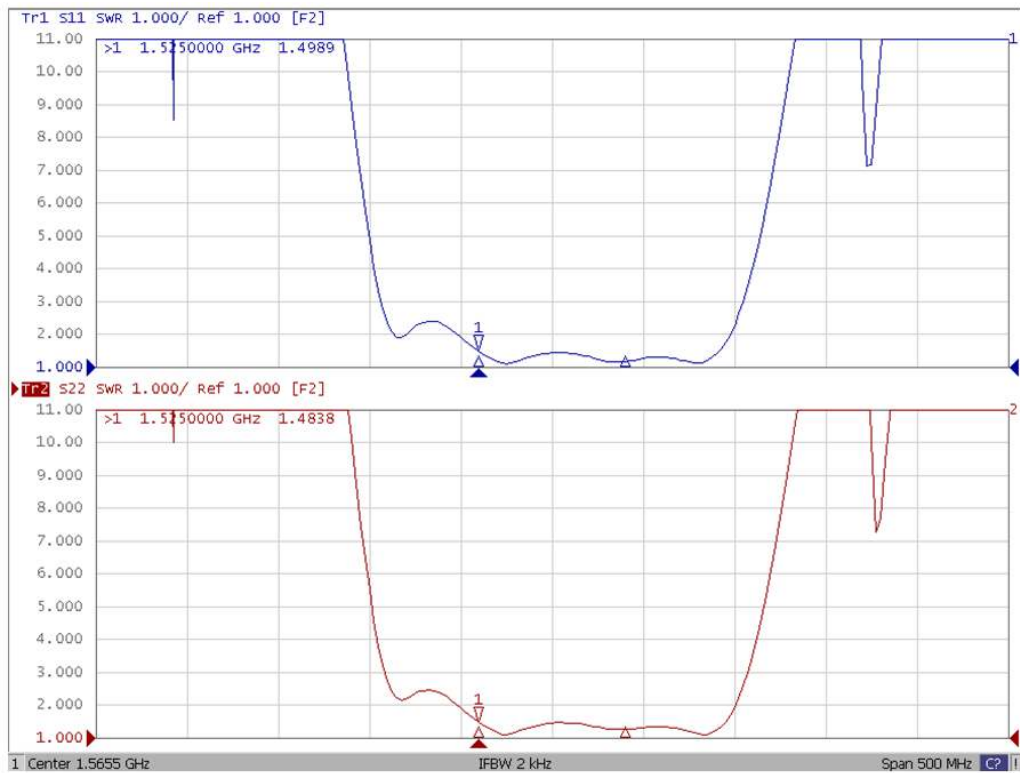

Wide Band Response

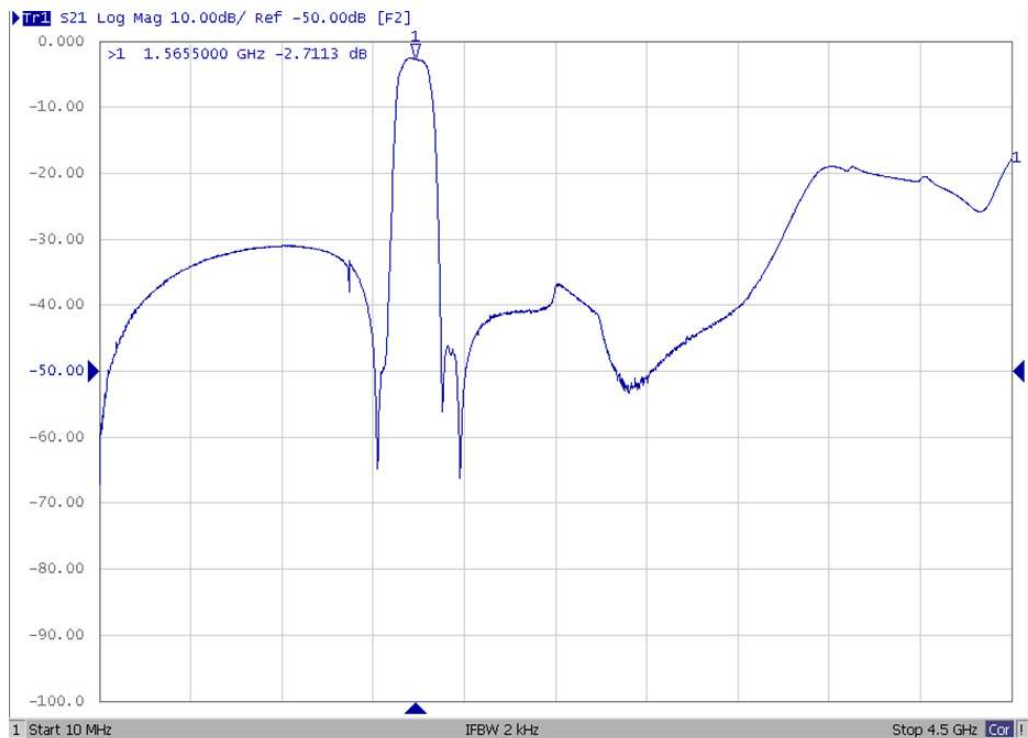

Format: LogMag REF: 0dB

S21 10dB/div



S11 5dB/div

S22 5dB/div

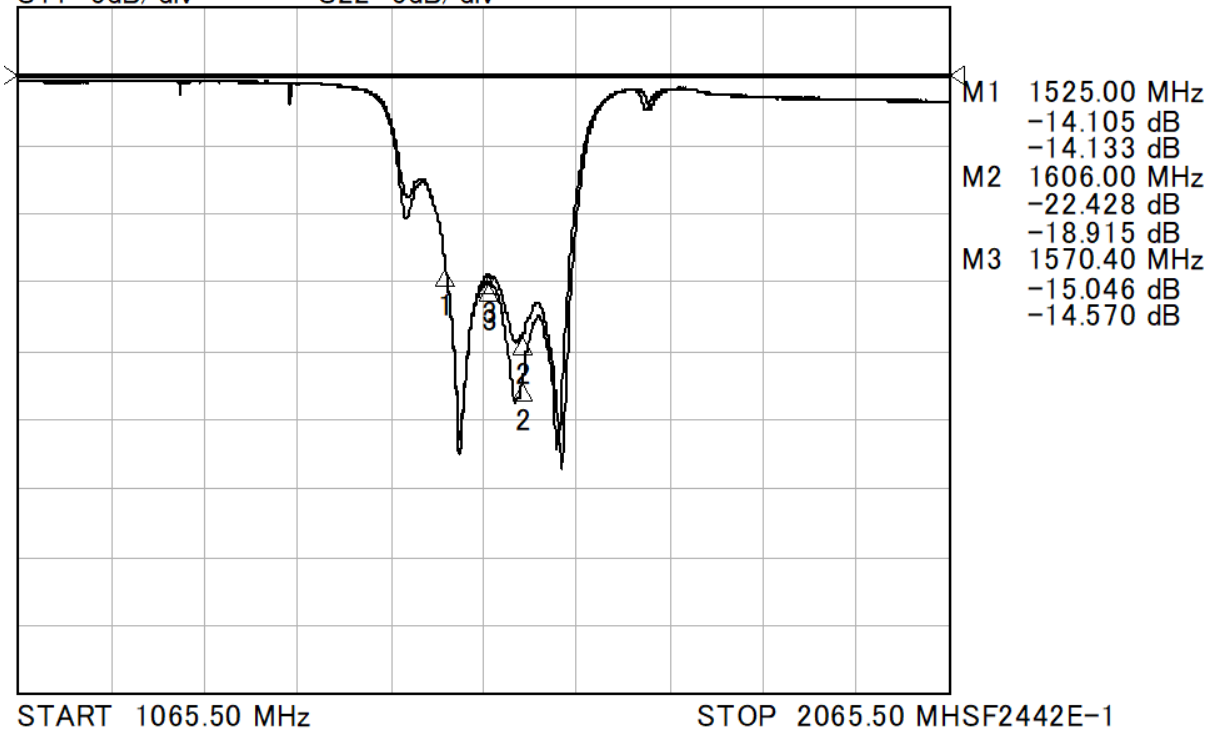

SM3030-6 Case

6-Terminal Ceramic Surface-Mount Case 3.0 X 3.0 mm Nominal Footprint

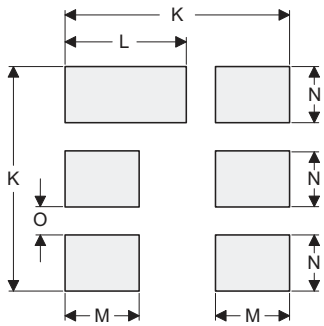
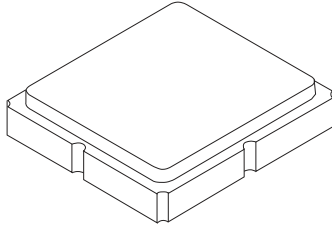

PCB Footprint Top View

Case and PCB Footprint Dimensions

Dimension	mm			Inches		
	Min	Nom	Max	Min	Nom	Max
A	2.87	3.00	3.13	0.113	0.118	0.123
B	2.87	3.00	3.13	0.113	0.118	0.123
C	1.12	1.25	1.38	0.044	0.049	0.054
D	0.77	0.90	1.03	0.030	0.035	0.040
E	2.67	2.80	2.93	0.105	0.110	0.115
F	1.47	1.60	1.73	0.058	0.063	0.068
G	0.72	0.85	0.98	0.028	0.033	0.038
H	1.37	1.50	1.63	0.054	0.059	0.064
I	0.47	0.60	0.73	0.019	0.024	0.029
J	1.17	1.30	1.43	0.046	0.051	0.056
K		3.20			0.126	
L		1.70			0.067	
M		1.05			0.041	
N		0.81			0.032	
O		0.38			0.015	
P	0.15	0.30	0.45	0.005	0.011	0.017
Q	0.07	0.20	0.36	0.002	0.007	0.014
R	0.62	0.7	0.78	0.024	0.027	0.030

Case Materials

Materials	
Solder Pad Plating	0.3 to 1.0 μm Gold over 1.27 to 8.89 μm Nickel
Lid Plating	2.0 to 3.0 μm Nickel
Body	Al_2O_3 Ceramic

TOP VIEW

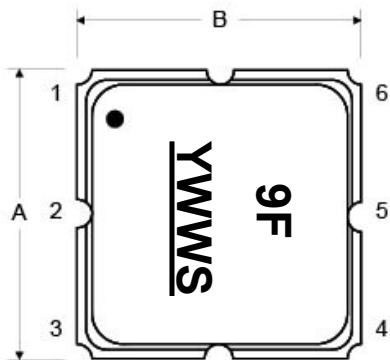

BOTTOM VIEW

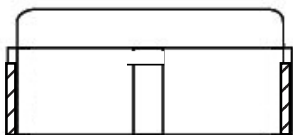
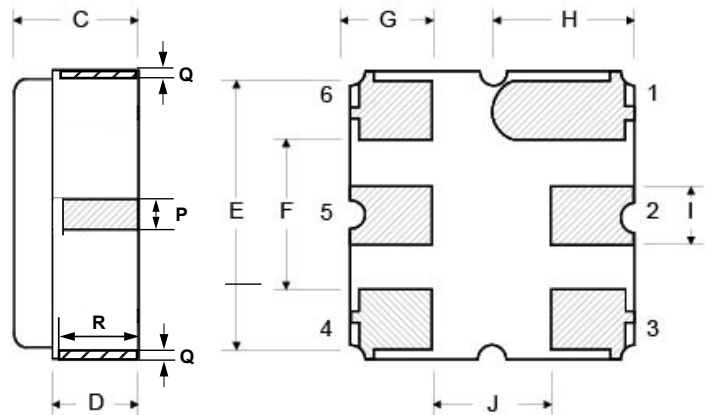

Tape and Reel Specifications

Tape and Reel Standard per ANSI/EIA-481

Reel Count:
7" = 500
13" = 3000

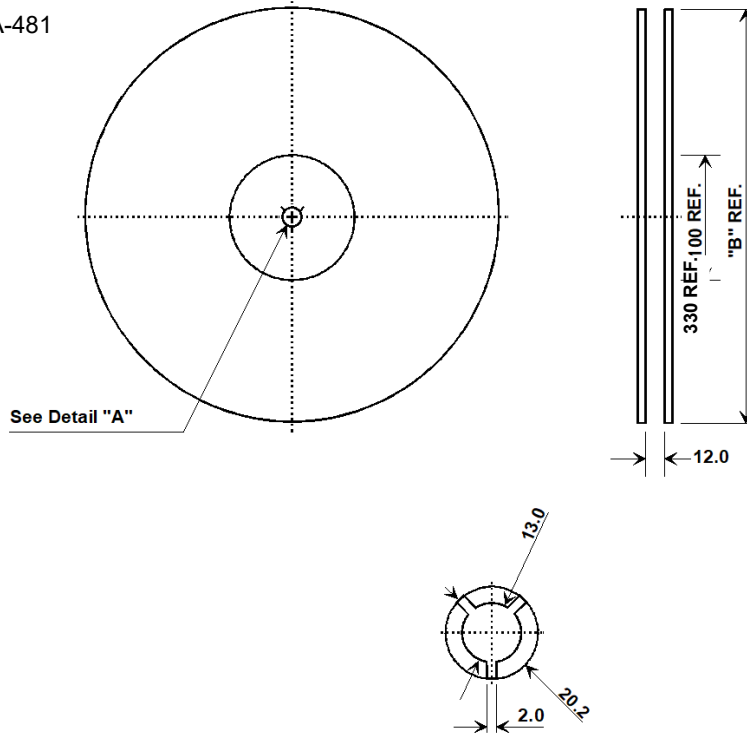

COMPONENT ORIENTATION and DIMENSIONS

Carrier Tape Dimensions	
Ao	3.3 mm
Bo	3.3 mm
Ko	1.4 mm
Pitch	4.0 mm
W	12.0 mm

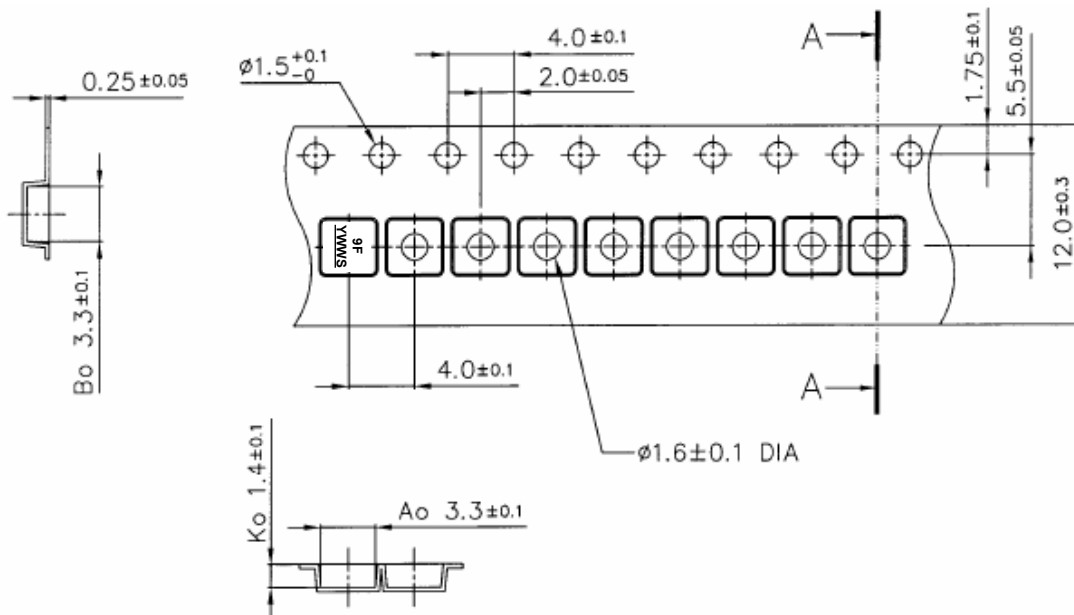

Recommended Reflow Profile

1. Preheating shall be fixed at 150~180°C for 60~90 seconds.
2. Ascending time to preheating temperature 150°C shall be 30 seconds min.
3. Heating shall be fixed at 220°C for 50~80 seconds and at 260°C +0/-5°C peak (10 seconds).
4. Time: 5 times maximum.

