



ATTENTION
OBSERVE PRECAUTIONS
FOR HANDLING
ELECTROSTATIC
DISCHARGE
SENSITIVE
DEVICES

Features

- 5.6mm x 3.0mm x 0.77mm SMD LED
- IR-reflow compatible
- Standard Package: 2,000pcs / Reel
- White SMD package with silicone resin
- MSL (Moisture Sensitivity Level): 2a
- RoHS compliant



Typical Applications

- Entertainment and accent lighting
- Architectural lighting
- Ideal substitute for halogen and florescent lighting
- Automotive interior and exterior lighting
- Specialty lighting (Markers, Beacon, Pathway)

Package Schematics

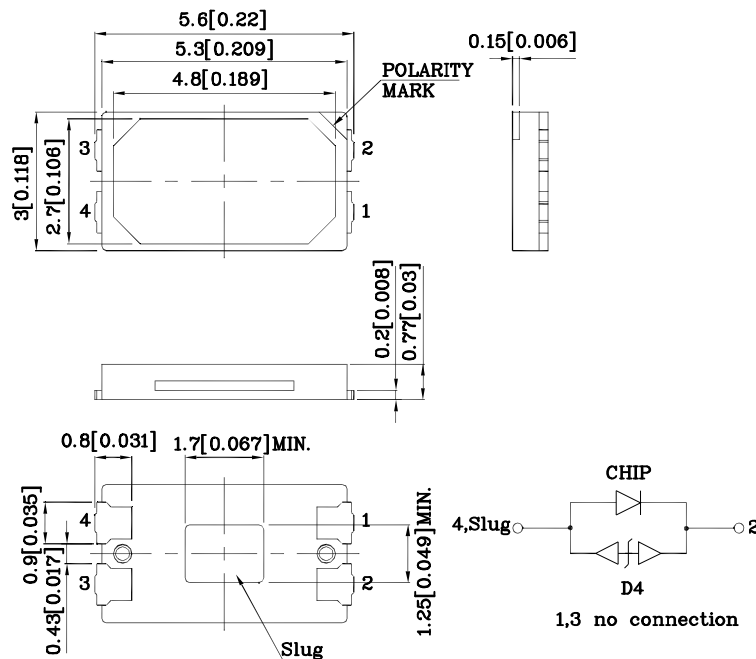

Notes:

1. All dimensions are in millimeters (inches).
2. Tolerance is $\pm 0.25(0.01)$ unless otherwise noted.
3. The specifications, characteristics and technical data described in the datasheet are subject to change without prior notice.

Handling Precautions

Compare to epoxy encapsulant that is hard and brittle, silicone is softer and flexible. Although its characteristic significantly reduces thermal stress, it is more susceptible to damage by external mechanical force.

As a result, special handling precautions need to be observed during assembly using silicone encapsulated LED products. Failure to comply might lead to damage and premature failure of the LED.

1. Handle the component along the side surfaces by using forceps or appropriate tools.

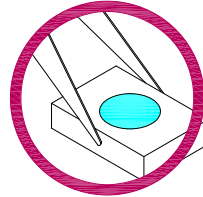

2. Do not directly touch or handle the silicone lens surface. It may damage the internal circuitry.

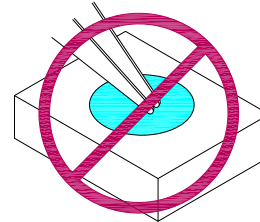
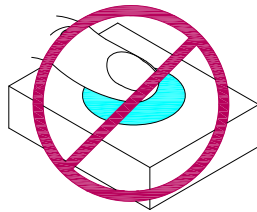

3. Do not stack together assembled PCBs containing exposed LEDs. Impact may scratch the silicone lens or damage the internal circuitry.

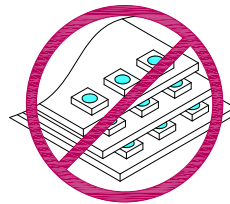

- 4.1. The inner diameter of the SMD pickup nozzle should not exceed the size of the LED to prevent air leaks.
- 4.2. A pliable material is suggested for the nozzle tip to avoid scratching or damaging the LED surface during pickup.
- 4.3. The dimensions of the component must be accurately programmed in the pick-and-place machine to insure precise pickup and avoid damage during production.

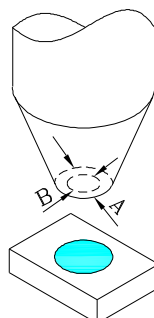

5. As silicone encapsulation is permeable to gases, some corrosive substances such as H₂S might corrode silver plating of leadframe. Special care should be taken if an LED with silicone encapsulation is to be used near such substances.

Part Number	Emitting Color	Emitting Material	Lens-color	Luminous Intensity CIE127-2007* (I _F =150mA) mcd		Luminous Flux CIE127-2007* (I _F =150mA) lm		Viewing Angle 2 θ 1/2
				Min.	Typ.	Min.	Typ.	
XZMOLA143S	Red	AlGaInP	Water Clear	3600*	4190*	12*	13.7*	120°

Notes:

1. θ 1/2 is the angle from optical centerline where the luminous intensity is 1/2 of the optical peak value.
 2. Luminous intensity / luminous flux: +/-15%.
 3. LEDs are binned according to their luminous flux.
- * Luminous intensity / luminous flux value is in accordance with CIE127-2007 standards.

Absolute Maximum Ratings at T_A=25°C

Parameter	Symbol	Value	Unit
Power Dissipation	P _D	450	mW
Junction Temperature [1]	T _J	110	°C
Operating Temperature	T _{op}	-40 ~ +85	°C
Storage Temperature	T _{stg}	-40 ~ +85	°C
DC Forward Current [1]	I _F	150	mA
Reverse Voltage	V _R	5	V
Peak Forward Current [2]	I _{FM}	270	mA
Thermal Resistance [1] (Junction/ambient)	R _{th j-a}	130	°C/W
Thermal Resistance [1] (Junction/solder point)	R _{th j-s}	60	°C/W
Electrostatic Discharge Threshold (HBM)		8000	V

Notes:

1. R_{th(j-a)} Results from mounting on PC board FR4 (pad size≥16 mm² per pad)
2. 1/10 Duty Cycle, 0.1ms Pulse Width.
3. A Relative Humidity between 40% and 60% is recommended in ESD-protected work areas to reduce static build up during assembly process (Reference JEDEC/JESD625-A and JEDEC/J-STD-033)

Electrical / Optical Characteristics at T_A=25°C

Parameter	Symbol	Value			Unit
		Min.	Typ.	Max.	
Wavelength at peak emission CIE127-2007* I _F =150mA	λ _{peak}		631*		nm
Dominant Wavelength CIE127-2007* I _F =150mA	λ _{dom} [1]		623*		nm
Spectral bandwidth at 50% Φ _{REL MAX} I _F = 150mA	Δλ		25		nm
Forward Voltage I _F =150mA	V _F [2]	2	2.5	3.0	V
Allowable Reverse Current	I _R			85	mA
Temperature coefficient of λ _{peak} I _F =150mA, -10°C ≤ T ≤ 100°C	TCλ _{peak}		0.11		nm/°C
Temperature coefficient of λ _{dom} I _F =150mA, -10°C ≤ T ≤ 100°C	TCλ _{dom}		0.09		nm/°C
Temperature coefficient of V _F I _F =150mA, -10°C ≤ T ≤ 100°C	TC _V		-2.6		mV/°C

Notes:

1. The dominant Wavelength (λ_d) above is the setup value of the sorting machine. (Tolerance λ_d : ±1nm.)
 2. Forward Voltage: +/-0.1V.
- * Wavelength is in accordance with CIE127-2007 standards.

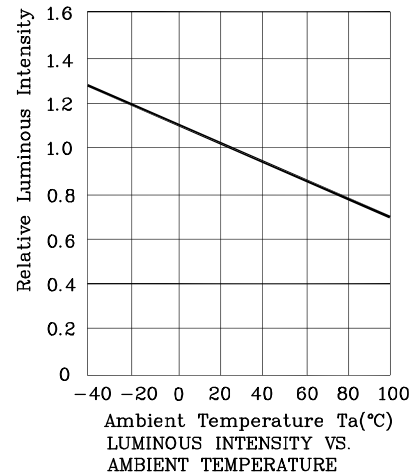
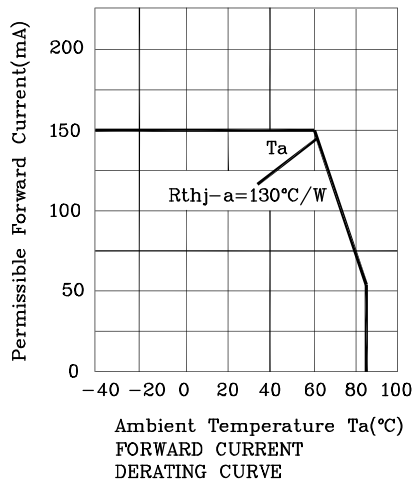
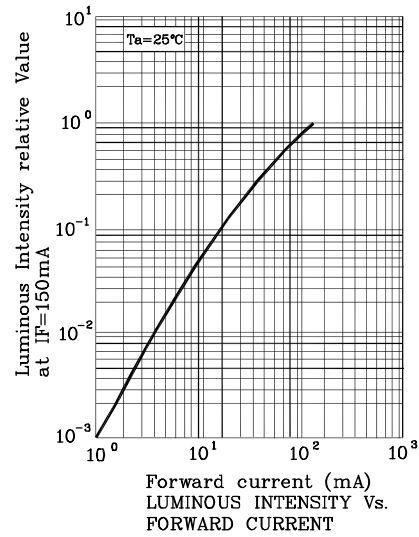
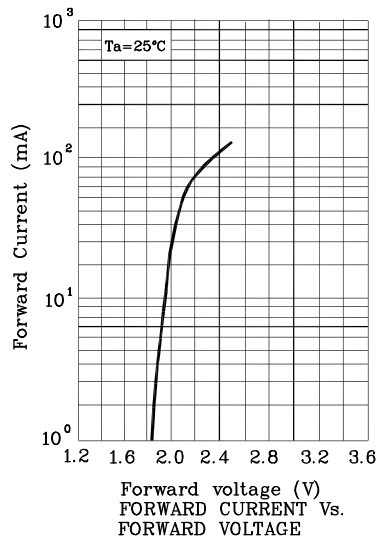
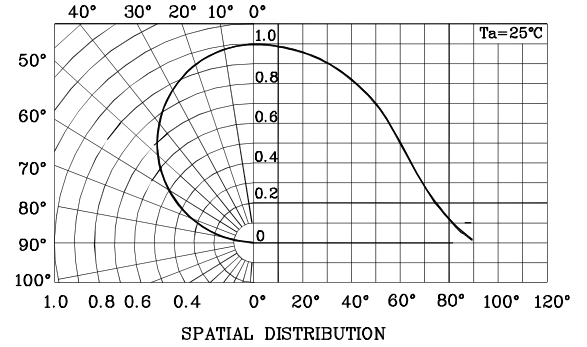
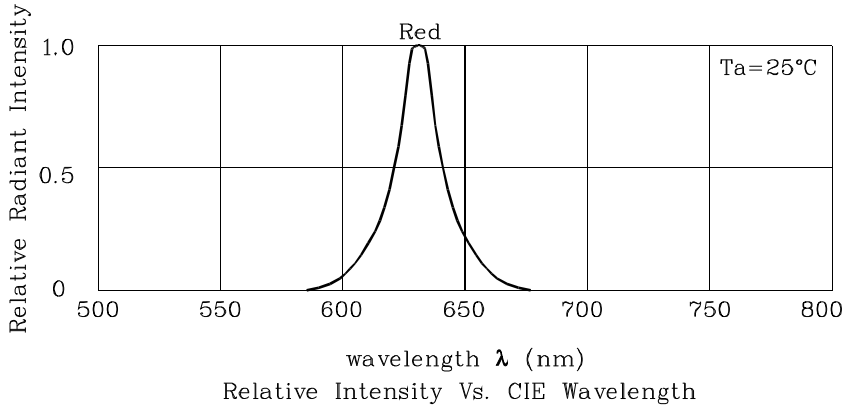

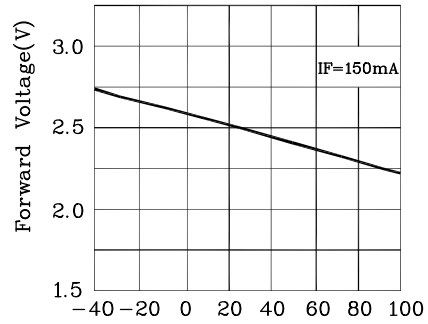

Ambient Temperature T_a (°C)
FORWARD VOLTAGE VS.
AMBIENT TEMPERATURE

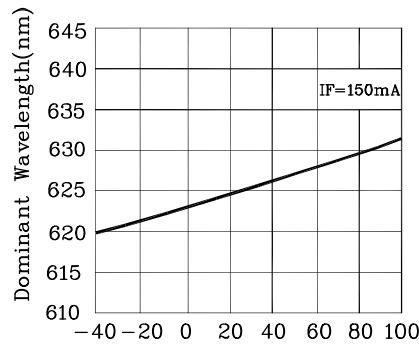

Ambient Temperature T_a (°C)
DOMINANT WAVELENGTH VS
AMBIENT TEMPERATURE

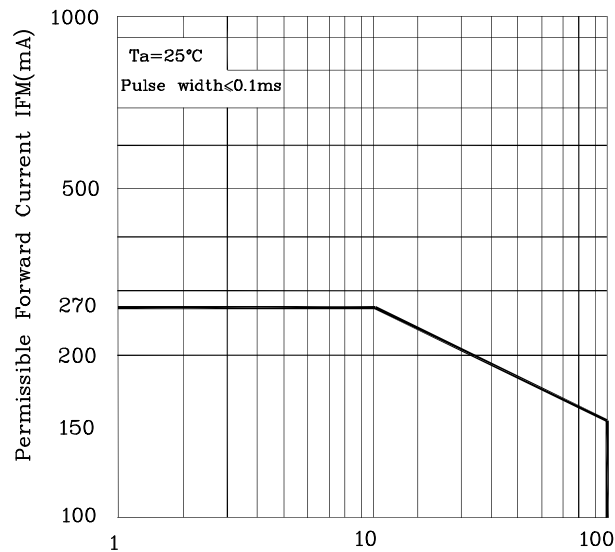

Duty Cycle (%)
Permissible Forward
Current VS Duty Cycle

LED is recommended for reflow soldering and soldering profile is shown below.

Reflow Soldering Profile for SMD Products (Pb-Free Components)

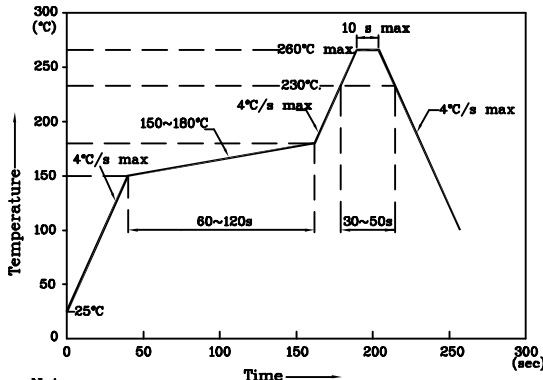

Notes:

1. Maximum soldering temperature should not exceed 260°C
2. Recommended reflow temperature: 145°C-260°C
3. Do not put stress to the epoxy resin during high temperatures conditions

Reel Dimension

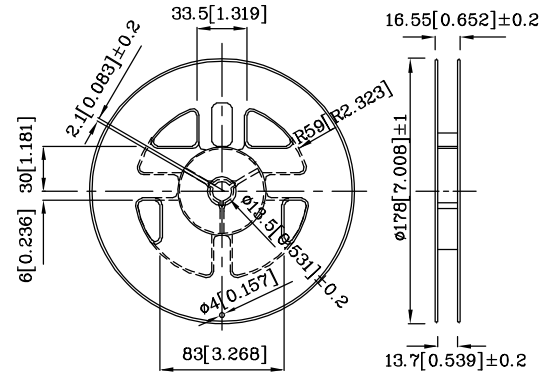

Recommended Soldering Pattern
(Units : mm; Tolerance: ±0.1)

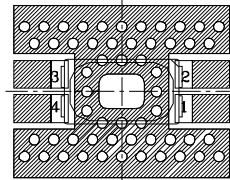
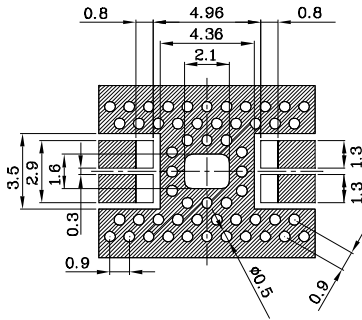

☒ Solder resist

❖ The device has a single mounting surface. The device must be mounted according to the specifications.

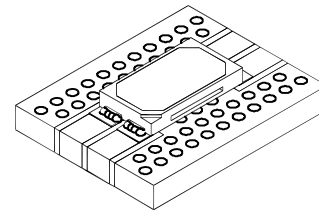

0.8mm FR4-Based Boards

For both the open via PTH and filled and capped via design, the finished hole diameter is 0.5mm. A smaller diameter will lead to an increase of thermal resistance. The recommended distance between two holes is 0.4 mm. This results in a minimal pitch of 0.9mm between the vias.

❖ Tape Specification (Units : mm)

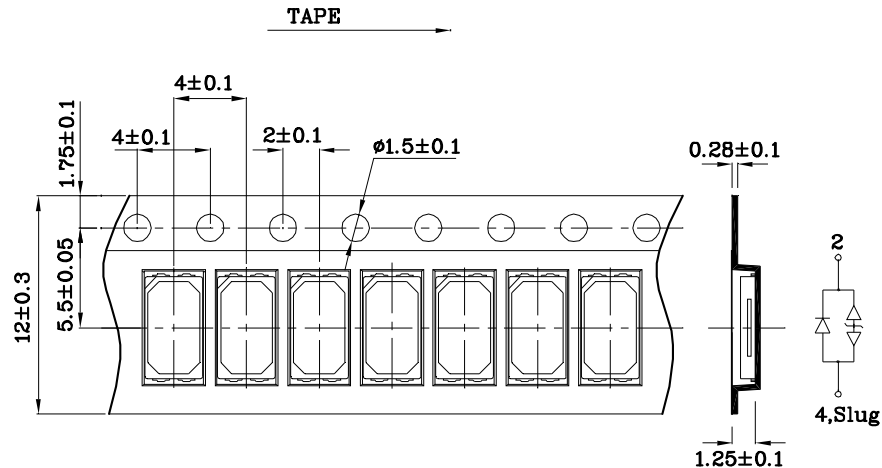

PACKING & LABEL SPECIFICATIONS

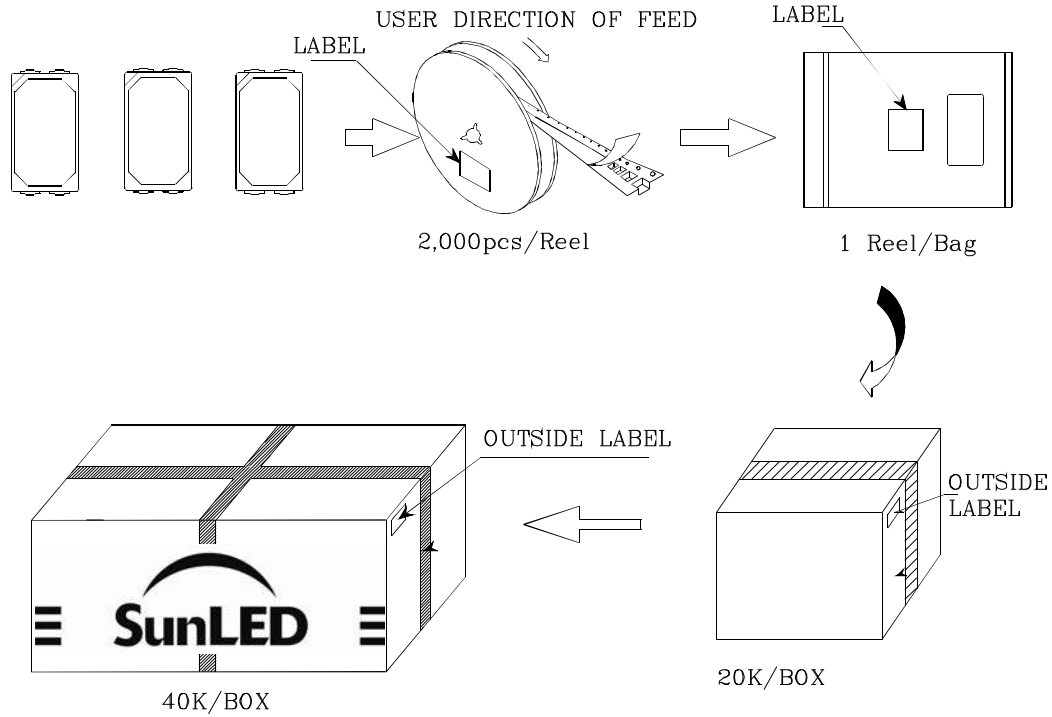



Q.C.

Q C

XX XX XXXX

PASSED

P/NO : XZxxx143x	
QTY : 2,000 pcs	CODE: XXX
S/N : XX	
LOT NO:	
 XXXXXXXXXXXXXXXXXXXXXXXXXXXX	
RoHS Compliant	

TERMS OF USE

1. Data presented in this document reflect statistical figures and should be treated as technical reference only.
2. Contents within this document are subject to improvement and enhancement changes without notice.
3. The product(s) in this document are designed to be operated within the electrical and environmental specifications indicated on the datasheet. User accepts full risk and responsibility when operating the product(s) beyond their intended specifications.
4. The product(s) described in this document are intended for electronic applications in which a person's life is not reliant upon the LED. Please consult with a SunLED representative for special applications where the LED may have a direct impact on a person's life.
5. The contents within this document may not be altered without prior consent by SunLED.
6. Additional technical notes are available at <http://www.SunLEDusa.com/TechnicalNotes.asp>