

BCW31

NPN General Purpose Amplifier

- This device is designed for general purpose applications at collector currents to 300mA.
- Sourced from process 10.

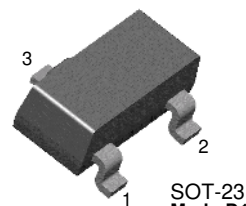

SOT-23
Mark: D1
1. Base 2. Emitter 3. Collector

Absolute Maximum Ratings * $T_a=25^\circ\text{C}$ unless otherwise noted

Symbol	Parameter	Value	Units
V_{CEO}	Collector-Emitter Voltage	32	V
V_{CBO}	Collector-Base Voltage	32	V
V_{EBO}	Emitter-Base Voltage	5.0	V
I_C	Collector current (DC)	500	mA
T_J, T_{stg}	Operating and Storage Junction Temperature Range	-55 ~ +150	$^\circ\text{C}$

* These ratings are limiting values above which the serviceability of any semiconductor device may be impaired.

NOTES:

- 1) These ratings are based on a maximum junction temperature of 150 degrees C.
- 2) These are state limits. The factory should be consulted on applications involving pulsed or low duty cycle operations.

Electrical Characteristics $T_a=25^\circ\text{C}$ unless otherwise noted

Symbol	Parameter	Test Condition	Min.	Typ.	Max.	Units
Off Characteristics						
$V_{(BR)CBO}$	Collector-Base Breakdown Voltage	$I_C = 2.0\text{mA}, I_B = 0$	32			V
$V_{(BR)CEO}$	Collector-Emitter Breakdown Voltage	$I_C = 10\mu\text{A}, I_B = 0$	32			V
$V_{(BR)EBO}$	Emitter-Base Breakdown Voltage	$I_C = 10\mu\text{A}, I_C = 0$	5.0			V
I_{CBO}	Collector Cutoff Current	$V_{CB} = 32\text{V}, I_E = 0$ $V_{CB} = 32\text{V}, I_E = 0, T_A = 100^\circ\text{C}$			100 10	nA μA
On Characteristics						
h_{FE}	DC Current Gain	$I_C = 2.0\text{mA}, V_{CE} = 5.0\text{V}$	110		220	
$V_{CE(sat)}$	Collector-Emitter Saturation Voltage	$I_C = 10\text{mA}, I_B = 0.5\text{mA}$			0.25	V
$V_{BE(on)}$	Base-Emitter On Voltage	$I_C = 2.0\text{mA}, V_{CE} = 5.0\text{V}$	0.55		0.7	V
Small Signal Characteristics						
f_T	Current Gain Bandwidth Product	$I_C = 2.0\text{mA}, V_{CE} = 5.0\text{V}$ $f = 35\text{MHz}$	200			
C_{obo}	Output Capacitance	$V_{CB} = 10\text{V}, I_E = 0, f = 1.0\text{MHz}$			4.0	pF
NF	Noise Figure	$I_C = 0.2\text{mA}, V_{CE} = 5.0\text{V}$ $R_S = 2.0\text{k}\Omega, f = 1.0\text{kHz}$ $B_W = 200\text{Hz}$			10	dB

Thermal Characteristics $T_a=25^\circ\text{C}$ unless otherwise noted

Symbol	Parameter	Max.	Units
P_D	Total Device Dissipation Derate above 25°C	350 2.8	mW mW/ $^\circ\text{C}$
$R_{\theta JA}$	Thermal Resistance, Junction to Ambient	357	$^\circ\text{C}/\text{W}$

Device mounted on FR-4PCB 40mm x 40mm x 1.5mm

Typical Characteristics

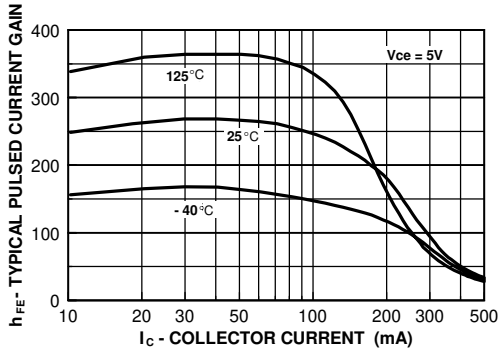

Figure 1. Typical Pulsed Current Gain vs Collector Current

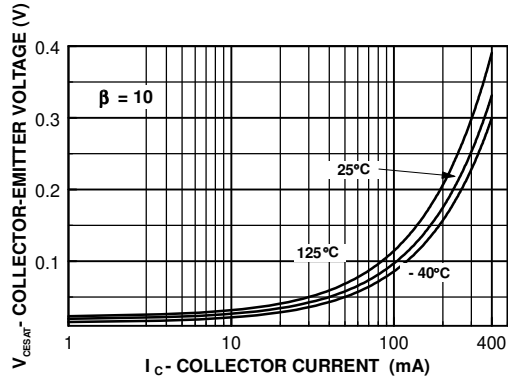

Figure 2. Collector-Emitter Saturation Voltage vs Collector Current

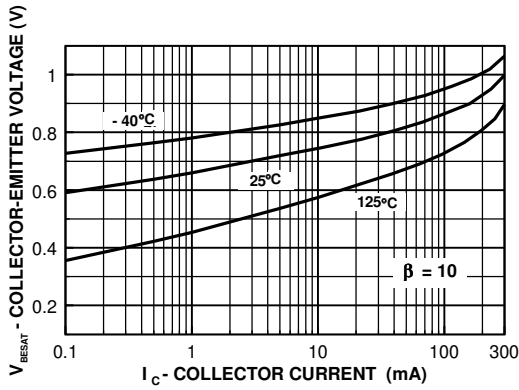

Figure 3. Base-Emitter Saturation Voltage vs Collector Current

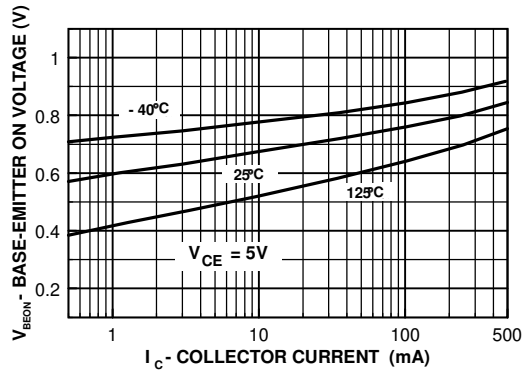

Figure 4. Base-Emitter On Voltage vs Collector Current

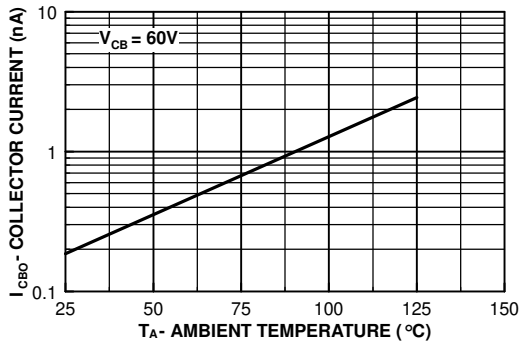

Figure 5. Collector-Cutoff Current vs Ambient Temperature

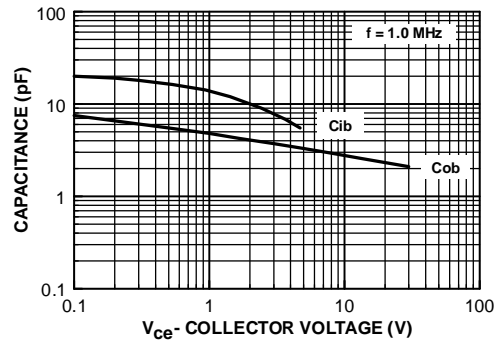

Figure 6. Input and Output Capacitance vs Reverse Voltage

Typical Characteristics (Continued)

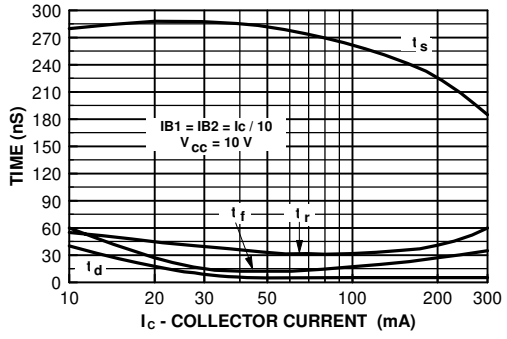

Figure 7. Switching Times vs Collector Current

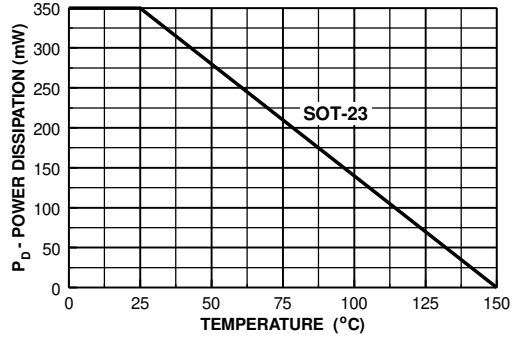
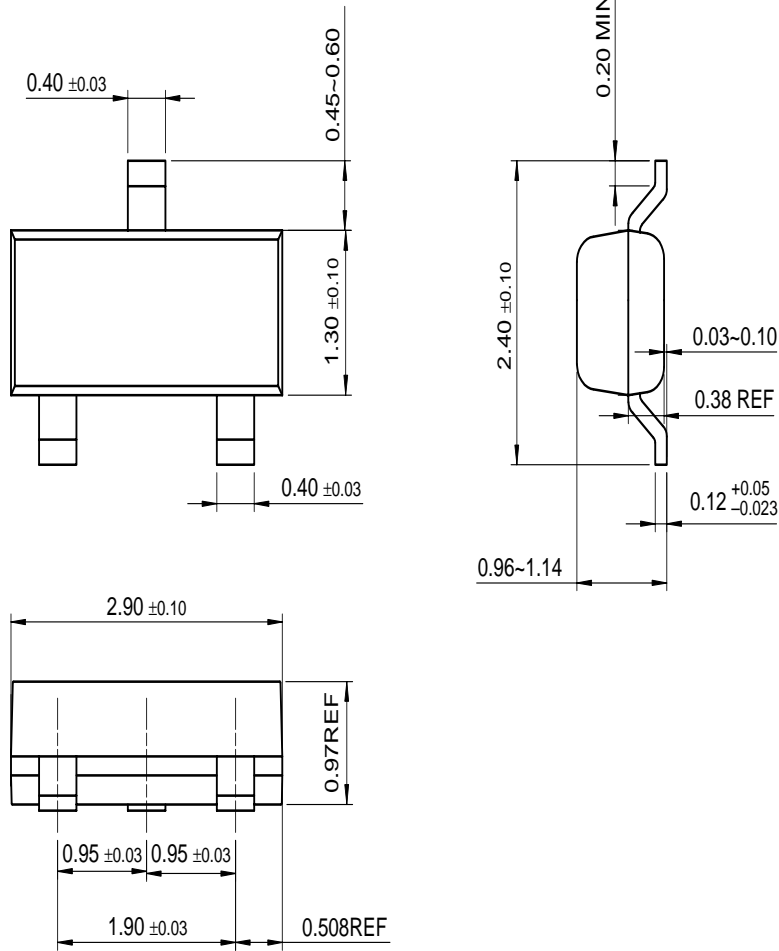

Figure 8. Power Dissipation vs Ambient Temperature

Package Dimensions

SOT-23



Dimensions in Millimeters

TRADEMARKS

The following are registered and unregistered trademarks Fairchild Semiconductor owns or is authorized to use and is not intended to be an exhaustive list of all such trademarks.

ACE ^x TM	FACT TM	ImpliedDisconnect TM	PACMAN TM	SPM TM
ActiveArray TM	FACT Quiet series TM	ISOPLANAR TM	POP TM	Stealth TM
Bottomless TM	FAST [®]	LittleFET TM	Power247 TM	SuperSOT TM -3
CoolFET TM	FAST ^r TM	MicroFET TM	PowerTrench [®]	SuperSOT TM -6
CROSSVOL TM	FRFET TM	MicroPak TM	QFET TM	SuperSOT TM -8
DOME TM	GlobalOptoisolator TM	MICROWIRE TM	QS TM	SyncFET TM
EcoSPARK TM	GTO TM	MSX TM	QT Optoelectronics TM	TinyLogic TM
E ² CMOS TM	HiSeC TM	MSXPro TM	Quiet Series TM	TruTranslation TM
EnSigna TM	I ² C TM	OCX TM	RapidConfigure TM	UHC TM
Across the board. Around the world. TM		OCXPro TM	RapidConnect TM	UltraFET [®]
The Power Franchise TM		OPTOLOGIC [®]	SILENT SWITCHER [®]	VCX TM
Programmable Active Droop TM		OPTOPLANAR TM	SMART START TM	

DISCLAIMER

FAIRCHILD SEMICONDUCTOR RESERVES THE RIGHT TO MAKE CHANGES WITHOUT FURTHER NOTICE TO ANY PRODUCTS HEREIN TO IMPROVE RELIABILITY, FUNCTION OR DESIGN. FAIRCHILD DOES NOT ASSUME ANY LIABILITY ARISING OUT OF THE APPLICATION OR USE OF ANY PRODUCT OR CIRCUIT DESCRIBED HEREIN; NEITHER DOES IT CONVEY ANY LICENSE UNDER ITS PATENT RIGHTS, NOR THE RIGHTS OF OTHERS.

LIFE SUPPORT POLICY

FAIRCHILD'S PRODUCTS ARE NOT AUTHORIZED FOR USE AS CRITICAL COMPONENTS IN LIFE SUPPORT DEVICES OR SYSTEMS WITHOUT THE EXPRESS WRITTEN APPROVAL OF FAIRCHILD SEMICONDUCTOR CORPORATION.

As used herein:

1. Life support devices or systems are devices or systems which, (a) are intended for surgical implant into the body, or (b) support or sustain life, or (c) whose failure to perform when properly used in accordance with instructions for use provided in the labeling, can be reasonably expected to result in significant injury to the user.
2. A critical component is any component of a life support device or system whose failure to perform can be reasonably expected to cause the failure of the life support device or system, or to affect its safety or effectiveness.

PRODUCT STATUS DEFINITIONS

Definition of Terms

Datasheet Identification	Product Status	Definition
Advance Information	Formative or In Design	This datasheet contains the design specifications for product development. Specifications may change in any manner without notice.
Preliminary	First Production	This datasheet contains preliminary data, and supplementary data will be published at a later date. Fairchild Semiconductor reserves the right to make changes at any time without notice in order to improve design.
No Identification Needed	Full Production	This datasheet contains final specifications. Fairchild Semiconductor reserves the right to make changes at any time without notice in order to improve design.
Obsolete	Not In Production	This datasheet contains specifications on a product that has been discontinued by Fairchild semiconductor. The datasheet is printed for reference information only.