

650V N-Channel Super Junction MOSFET

Voltage	650 V	Rdson	210 mΩ
Current	19 A	Qg	34 nC

Feature:

- $R_{DS(ON) Max, V_{GS}@10V}$: 210mΩ
- Easy to use/ drive
- High Speed Switching and Low $R_{DS(ON)}$
- 100% Avalanche Tested
- 100% Rg Tested
- Lead free in compliance with EU RoHS 2.0
- Green molding compound as per IEC 61249 standard

Mechanical Data

- Case: TO-263 package
- Terminals: Solderable per MIL-STD-750, Method 2026
- Approx. Weight: 1.38 grams

Application

- PFC, TV Power, PC Power, PD Charger, Adapter, UPS

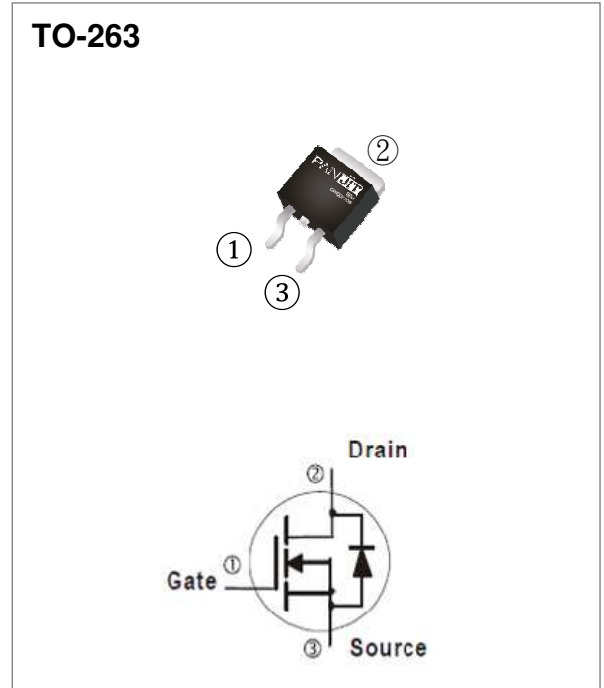

Absolute Maximum Ratings ($T_A = 25^\circ\text{C}$ unless otherwise specified)

PARAMETER		SYMBOL	LIMIT	UNITS
Drain-Source Voltage @ T_{jmax}		V_{DS}	700	V
Drain-Source Voltage		V_{DS}	650	
Gate-Source Voltage		V_{GS}	± 30	
Continuous Drain Current	$T_C=25^\circ\text{C}$	I_D	19.0	A
	$T_C=100^\circ\text{C}$		11.2	
Pulsed Drain Current	$T_C=25^\circ\text{C}$	I_{DM}	42	A
Single Pulse Avalanche Energy		E_{AS}	420	mJ
MOSFET dv/dt ruggedness		dv/dt	50	V/ns
Power Dissipation	$T_C=25^\circ\text{C}$	P_D	150	W
	$T_C=100^\circ\text{C}$		60	
Operating Junction and Storage Temperature Range		T_J, T_{STG}	-55~150	$^\circ\text{C}$

Thermal Characteristics

PARAMETER		SYMBOL	MAXIMUM	UNITS
Thermal Resistance	Junction-to-Case	$R_{\theta JC}$	0.83	$^\circ\text{C/W}$
	Junction-to-Ambient (Note 3)	$R_{\theta JA}$	62.5	$^\circ\text{C/W}$

Electrical Characteristics (T_A = 25 °C unless otherwise specified)

PARAMETER	SYMBOL	TEST CONDITION	MIN.	TYP.	MAX.	UNITS
Static						
Drain-Source Breakdown Voltage	BV _{DSS}	V _{GS} =0V, I _D =250uA	650	730	-	V
Gate Threshold Voltage	V _{GS(th)}	V _{DS} =V _{GS} , I _D =250uA	2	3.0	4	
Drain-Source On-State Resistance	R _{DS(on)}	V _{GS} =10V, I _D =9.5A ^(Note 1)	-	183	210	mΩ
Zero Gate Voltage Drain Current	I _{DSS}	V _{DS} =650V, V _{GS} =0V	-	-	1	uA
Gate-Source Leakage Current	I _{GSS}	V _{GS} =±30V, V _{DS} =0V	-	-	±100	nA
Transfer characteristics	gfs	V _{DS} =20V, I _D =19A	-	21.8	-	S
Dynamic ^(Note 5)						
Total Gate Charge	Q _g	V _{DS} =520V, I _D =19A, V _{GS} =10V	-	34	-	nC
Gate-Source Charge	Q _{gs}		-	7.7	-	
Gate-Drain Charge	Q _{gd}		-	13.5	-	
Input Capacitance	C _{iss}	V _{DS} =400V, V _{GS} =0V, f=250kHz	-	1412	-	pF
Output Capacitance	C _{oss}		-	50	-	
Reverse Transfer Capacitance	C _{rss}		-	6.8	-	
Effective Output Capacitance Energy Related	C _{o(er)}	V _{DS} =0V to 400V, V _{GS} =0V, f=250kHz ^(Note 4)	-	64	-	
Turn-On Delay Time	t _{d(on)}	V _{DD} =325V, I _D =19A, V _{GS} =10V, R _G =25Ω ^(Note 2)	-	30	-	ns
Turn-On Rise Time	t _r		-	65	-	
Turn-Off Delay Time	t _{d(off)}		-	111	-	
Turn-Off Fall Time	t _f		-	61	-	
Gate Resistance	R _g	f=1.0MHz	-	1.7	-	Ω
Drain-Source Diode						
Maximum Continuous Drain-Source Diode Forward Current	I _S		-	-	19	A
Diode Forward Voltage	V _{SD}	I _S =19A, V _{GS} =0V	-	0.9	1.5	V
Reverse Recovery Charge	Q _{rr}	I _S =19A	-	5.7	-	μC
Reverse Recovery Time	T _{rr}	di/dt=100A/μs	-	370	-	ns

NOTES :

1. Pulse width ≤ 300us, Duty cycle ≤ 2%
2. Essentially independent of operating temperature typical characteristics.
3. R_{θJA} is the sum of the junction-to-case and case-to-ambient thermal resistance.
4. C_{o(er)} is a capacitance that gives the same stored energy as C_{oss} while V_{DS} is rising from 0V to 80% V_{(BR)DSS}
5. Guaranteed by design, not subject to production testing

TYPICAL CHARACTERISTIC CURVES

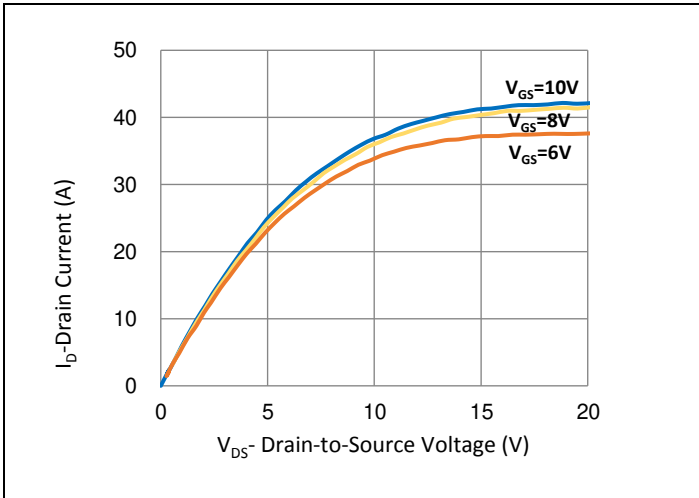

Fig.1 Output Characteristics

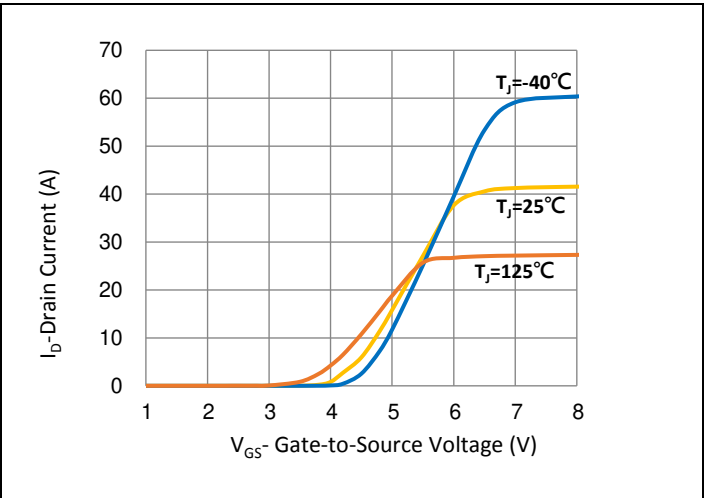

Fig.2 Transfer Characteristics

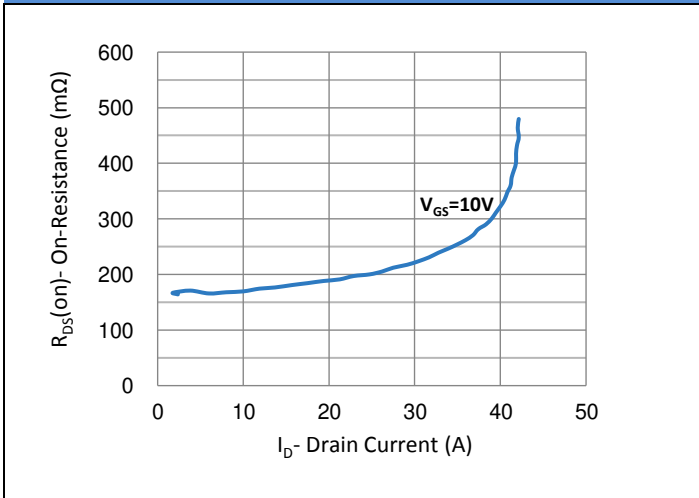

Fig.3 On-Resistance vs. Drain Current

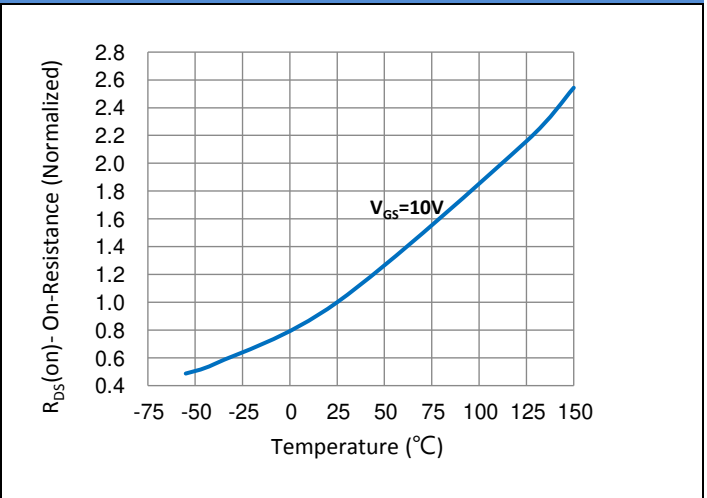

Fig.4 On-Resistance vs. Junction Temperature

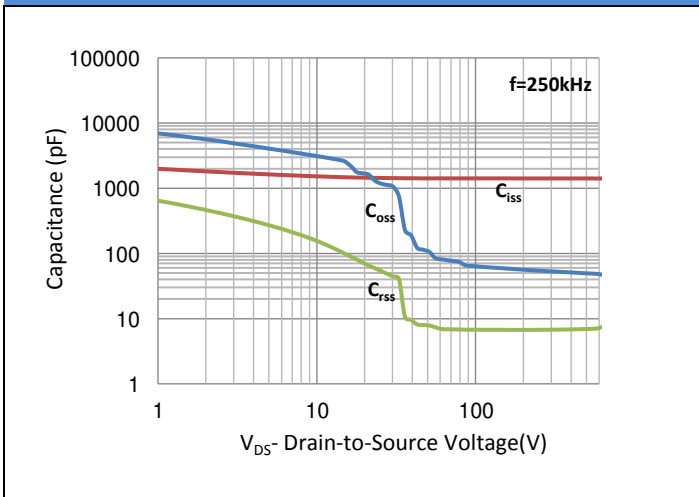

Fig.5 Capacitance vs. Drain-Source Voltage

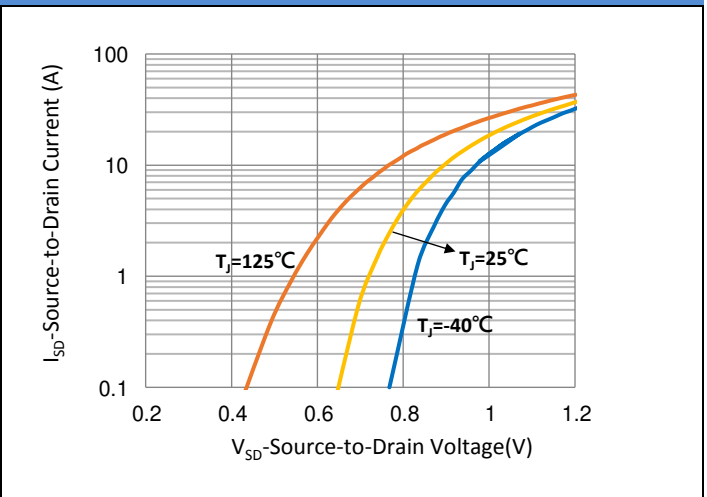

Fig.6 Source-Drain Diode Forward Voltage

TYPICAL CHARACTERISTIC CURVES

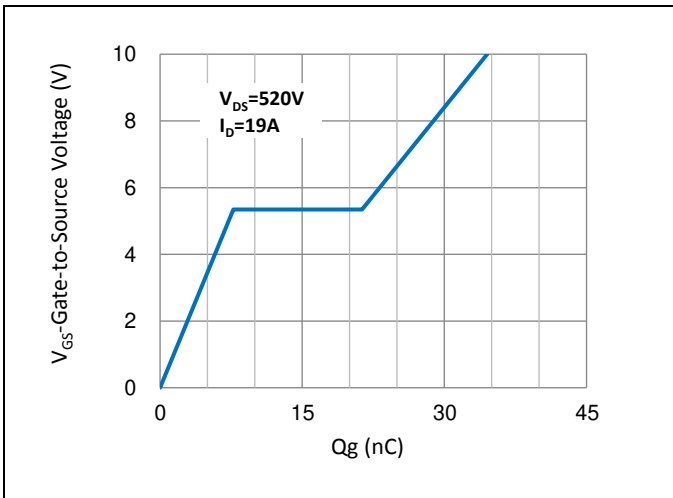

Fig.7 Gate-Charge Characteristics

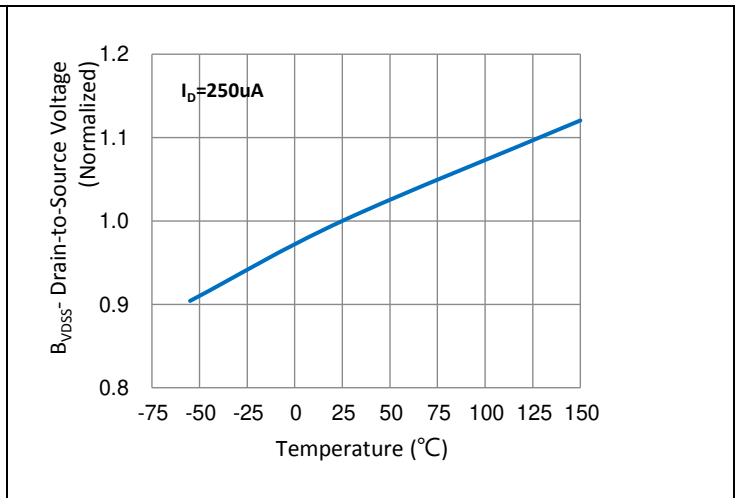

Fig.8 Breakdown Voltage Variation vs. Temperature

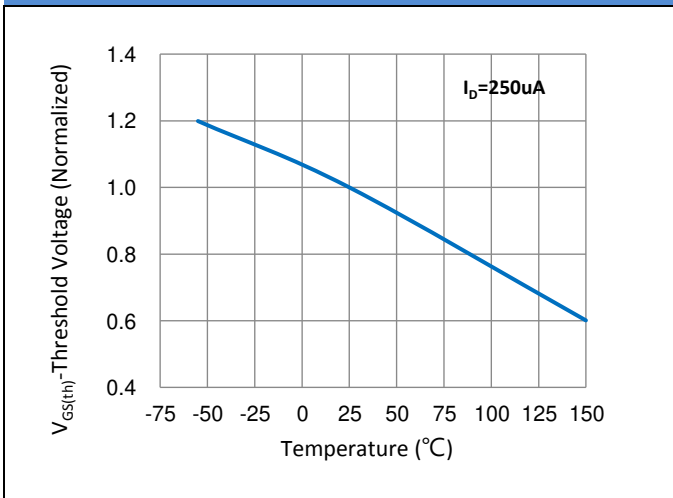

Fig.9 Threshold Voltage Variation with Temperature

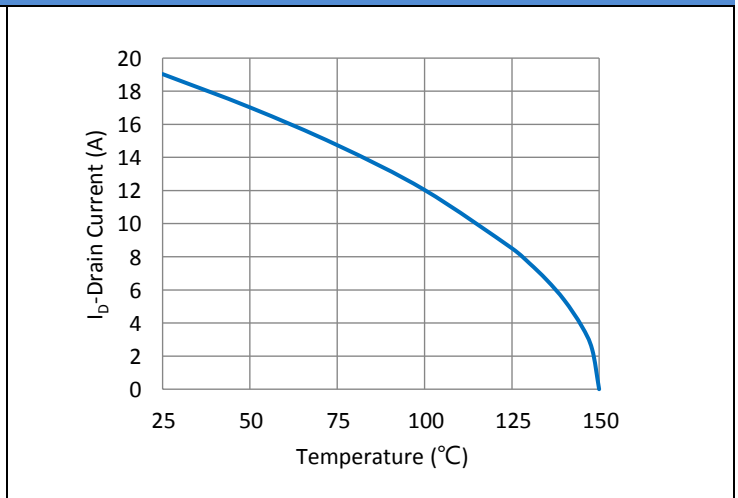

Fig.10 Drain Current vs. Case Temperature

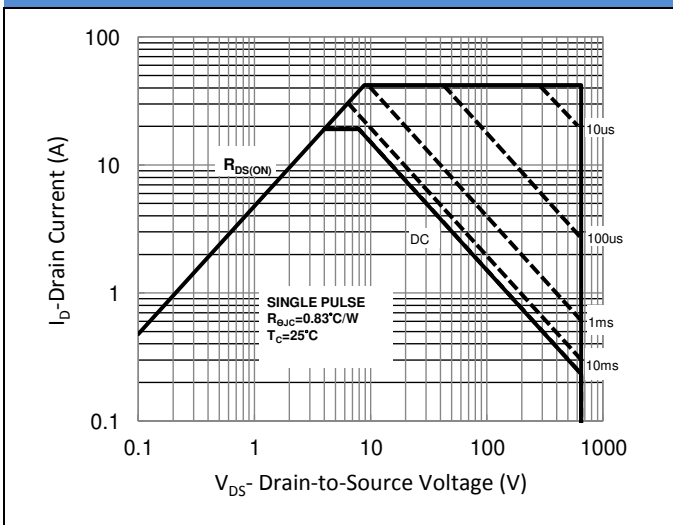

Fig.11 Maximum Safe Operating Area

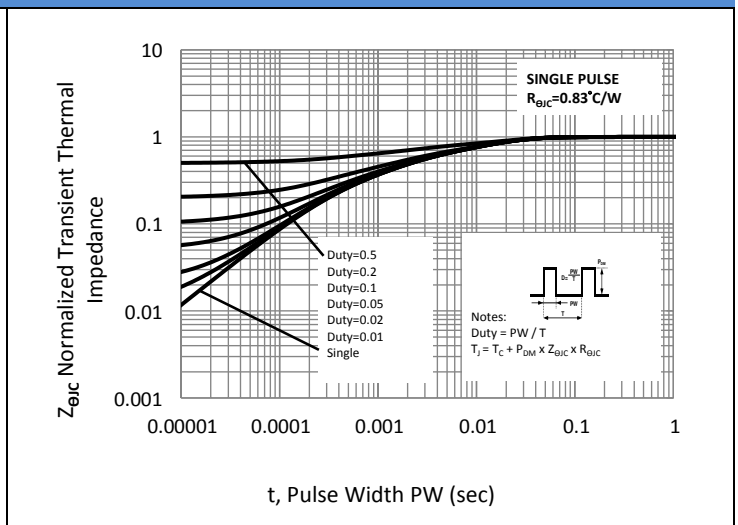

Fig.12 Normalized Transient Thermal Impedance

TYPICAL CHARACTERISTIC CURVES

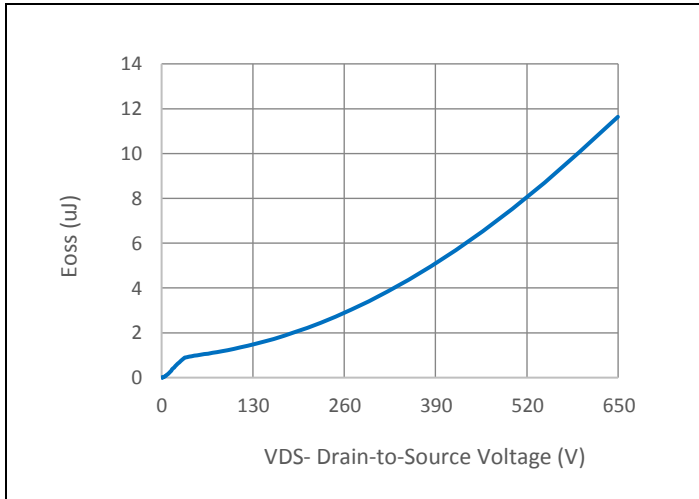
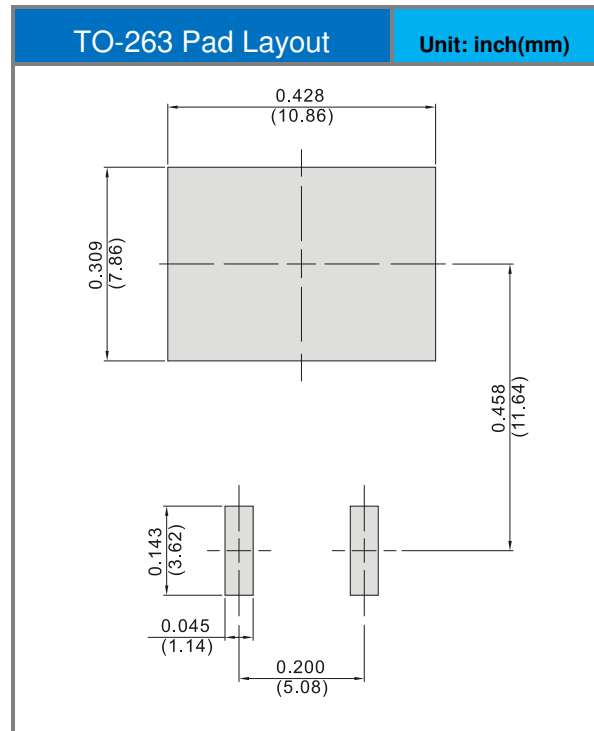
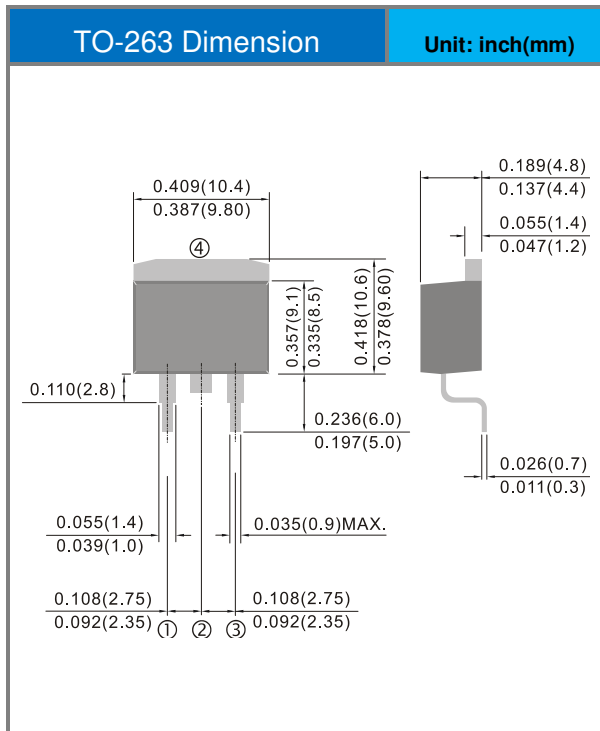

Fig.13 Typ. Coss Stored Energy

Product and Packing Information

Part No.	Package Type	Packing Type	Marking
PJMB210N65EC	TO-263	50pcs / Tube 800pcs / Reel	210N65EC

Packaging Information



Marking Diagram

PJ	Y = Year Code
210N65EC	W = Week Code (A~Z)
YWLL x	LL = Lot Code (00~99)
	x = Production Line Code

Disclaimer

- Reproducing and modifying information of the document is prohibited without permission from Panjit International Inc..
- Panjit International Inc. reserves the rights to make changes of the content herein the document anytime without notification. Please refer to our website for the latest document.
- Panjit International Inc. disclaims any and all liability arising out of the application or use of any product including damages incidentally and consequentially occurred.
- Panjit International Inc. does not assume any and all implied warranties, including warranties of fitness for particular purpose, non-infringement and merchantability.
- Applications shown on the herein document are examples of standard use and operation. Customers are responsible in comprehending the suitable use in particular applications. Panjit International Inc. makes no representation or warranty that such applications will be suitable for the specified use without further testing or modification.
- The products shown herein are not designed and authorized for equipments requiring high level of reliability or relating to human life and for any applications concerning life-saving or life-sustaining, such as medical instruments, transportation equipment, aerospace machinery et cetera. Customers using or selling these products for use in such applications do so at their own risk and agree to fully indemnify Panjit International Inc. for any damages resulting from such improper use or sale.
- Since Panjit uses lot number as the tracking base, please provide the lot number for tracking when complaining.